

Consumer Adoption of NFC Mobile Wallets

Antecedents of Usage

André Vitório Borges Pereira

Veileder: Herbjørn Nysveen

MSc. Economics and Business Administration

Master thesis

NORGES HANDELSHØYSKOLE

This thesis was written as a part of the Master of Science in Economics and Business Administration program - Major in International Business. Neither the institution, nor the advisor is responsible for the theories and methods used, or the results and conclusions drawn, through the approval of this thesis.

Table of Contents

Contents	2
1. Introduction	4
1.1 Background	4
1.2 Purpose	5
1.3 Contribution	6
1.3.1 Theoretical Contribution	6
1.3.2 Managerial Contribution.....	7
1.4 Outline of the paper	7
2. Near Field Communication (NFC) Payments	9
2.1 The NFC Technology	9
2.2 NFC Mobile Payments	11
2.2.1 Classification	12
2.2.2 Current Adoption and Trends.....	13
2.3 An Overview of Current NFC Mobile Payment Services	15
2.3.1 Google Wallet.....	15
2.3.2 ISIS	16
2.4 Criticism of NFC mobile payments	17
3. Theoretical Perspectives on the Adoption of Services	18
3.1 Multi-attribute Models	18
3.2 The Theory of Reasoned Action	20
3.2.1 Behavioral intentions, attitude and subjective norm	21
3.2.2 Belief Strength and Belief Evaluation.....	23
3.2.3 Normative Beliefs and Motivation to Comply.....	23
3.3 The Theory of Planned Behavior (TPB)	25
3.4 Technology Acceptance Model	27
3.5 The Technology Acceptance Model for Mobile Services	30
4. Model Development	34
4.1 Theory in the context of NFC mobile wallets	34
4.2 Drivers of intention to use NFC mobile wallets	35
4.3 The Model	37

4.4	Antecedent of Perceived Value of NFC mobile wallet services: Beliefs	38
4.4.1	Beliefs about Perceived Ease of Use	38
4.4.2	Beliefs about Security	43
4.4.3	Beliefs about Convenience.....	45
4.5	Antecedents of Intention to Use NFC mobile wallets.....	48
4.5.1	Perceived Value of the Service.....	48
4.5.2	Perceived Ease of Use	50
4.5.3	Trust.....	50
4.6	Perceived Ease of Adoption.....	52
5.	Methodology.....	53
5.1	Sample.....	53
5.2	Survey questions and measures.....	54
5.2.1	Suggested survey structure.....	56
5.3	Data analysis	58
6.	Managerial Implications	59
6.1	Limitations.....	61
	References	62

1. Introduction

1.1 Background

According to historical evidence the development of banking activities took place between 3000 and 2000 BC, while the use of money in the form of coins is assumed to have started around 600 BC (Davies and Davies, 2002). Payments have evolved a lot since then; governments and financial institutions are continuously pushing towards the development of easier, safer and traceable payments methods. Nowadays, a payment transaction is such a common part of everyday life that people rarely stop to question the nuances behind it. Wherever they go, people carry money in the format of cash, credit cards, debit cards, among others, which is usually kept in a wallet. Another customary human habit, which can be observed in most parts of the world, is that, besides the wallet, people tend to carry their keys and mobile device. Keys and money have existed for at least 4 thousand years (Davies and Davies, 2002; Ferscha, Holzmann and Resmerita, 2006), while the mobile phone is a fairly recent addition to that mix. In 2002, out of 100 people, only two had a mobile cellular subscription, while in 2010 the number grew to 78 (World Bank, 2012). In the last decade the mobile phone industry has entered a convergence race, as a result, the cellular phone is now equipped with plenty of features and can be used as a music player, camera, GPS, video game and more (Hall and Anderson, 2009), these new improved devices are commonly referred to as *smartphones*. Considering the technology available today, it wouldn't be a surprise that in the near future the smartphone is used as a replacement for keys and wallets. This paper deals with the latter.

Advances in mobile technology and the popularization of smartphones have created space for innovative companies to experiment with new payment solutions. Industry leaders argue that the convergence of smartphones and payments is inevitable (Smart Card Alliance, 2007). In this paper an analysis of the antecedents of adoption for a promising upcoming mobile payment solution, based on NFC (Near Field Communication) chips, named NFC mobile wallets is presented. Differently from most mobile payment technologies, NFC mobile wallets are used exclusively at the point-of-sale (POS), the service stores items people already carry in their wallets for purchase – such as credit cards, debit cards, coupons - in a digital form. Chapter 2 covers details on how it works.

The adoption of smartphones and the usage of mobile internet have soared in the past few years. Market research has shown that, on the third quarter of 2011, 44 percent of U.S. mobile subscribers own a smartphone device, compared to 18 percent in 2009 (Nielsen 2011). As mentioned previously, smartphones are known to perform, besides calling and text messaging, tasks such as web browsing and playing music; but consumers have also found these devices can be quite helpful while shopping. According to Google (Temsamani, 2011), 70% of smartphone users said they interact with their devices while in a store, with 79% of the users stating that they get help from their device when shopping to perform tasks such as price comparison, locating a retailer and acquiring product information. Several high profile companies such as Google, Visa, T-mobile and others (Garvín, 2011) are investing in ways consumers can make purchases using their smartphones in the point-of-sale.

In a world where consumers are given the option to use their mobile phones to pay at the point-of-sale (POS), what will make them inclined to use NFC mobile wallets? Which constructs will determine consumer's intention to use these mobile-based payment services? What are the behavioral elements that managers should focus on when developing their strategies? This paper assesses the NFC mobile wallets environment and reviews relevant consumer behavior literature to determine constructs that influence NFC mobile wallets adoption. A few hypotheses on how the constructs interact with each other and a methodology to empirically verify these relations, including data analysis suggestions is proposed.

1.2 Purpose

The main purpose of this paper is to develop a model that aids in determining the antecedents of usage for NFC mobile wallets. Based on theoretical approaches, nine hypotheses, covering the main determinants and beliefs that significantly influence adoption, are presented and suggestions on how they can be empirically verified are given.

In summary, the paper aims at providing a better understanding of the consumer's adoption process of NFC mobile wallets. The findings and results contained in this study can benefit managers who work in the NFC mobile wallet's industry to develop better strategies for user acquisition and help researchers in the investigation of issues related to mobile payments and as well as payment methods in general.

1.3 Contribution

Currently used by only a small fraction of the world's populations, NFC technology is forecasted to achieve tremendous usage growth (Thompson, 2012). In the case these predictions turn out to be true this would open the doors for NFC mobile wallets to become an integral part of people's lives; holding a place among current popular transaction methods, such as credit and debit cards. This study anticipates mass adoption of the technology and attempts to be one of the first consumer behavior studies directed at consumer adoption of NFC mobile wallets.

1.3.1 Theoretical Contribution

Consumer behavior literature offers theoretical approaches on how to determine the antecedents of a wide range of behaviors. The reason behind determining these antecedents vary but are often linked to the development of marketing strategies that aims at shaping people's opinions and favorably influencing attitude towards the usage of products and services (Hale, Householder and Greene, 2002).

This paper's theoretical contribution is to add more insight into consumer behavior literature regarding the adoption of NFC mobile wallets; accomplished by the development of an extension of the Technology Acceptance Model (Davis, 1986), which can be used to determine the antecedents of usage of this technology. Although a considerable number of researchers have studied consumers' adoption for other kinds of mobile payments (Dahlberg et al., 2007; Dass and Pal, 2011), such as SMS payments and online shopping using a mobile device, literature on NFC mobile wallets services is still in its infancy. Payments with mobile phones that support NFC chips have been in use for a few years (Paus, 2007; Graham, 2011; Dodson and Lam, 2011) and there are a few studies on methods using the technology, but NFC mobile wallets have only received modest attention so far. Due to the fact that NFC mobile wallets are supported by specific features included in new smartphone models and only made possible by the recent interest of stakeholder groups involved in payment processing, such as mobile carriers, banks, credit card processors and among others, the lack of literature on the subject is comprehensible.

The extension was developed based on a structured approach using previous literature on consumer behavior theory and other studies relevant to determine the constructs that compose the model.

1.3.2 Managerial Contribution

The creation of marketing campaigns and the development or improvement of specific features for products and services can be more efficient if based on information pertaining to consumer's perception regarding the services or products these organizational efforts are trying to address. Once the elements that influence consumer's intention to adopt NFC mobile wallets are identified, managers can develop strategies that precisely target constructs relevant to consumers' attitude towards the usage of such services. The paper doesn't limit itself at presenting these constructs but also covers how they relate to, and influence, each other during the adoption process.

Suggestions are included on how to direct managerial strategies towards each of the constructs identified by the research and hypotheses proposed by the model. This study should serve as a guideline for strategy development for marketing managers, product development managers, as well as other professionals involved in the process of developing NFC mobile wallet services.

1.4 Outline of the paper

This paper is structured in the following fashion:

The first and current chapter serves as an introduction to the paper, so that readers can become familiar with the subject of the study. Chapter 2 aims at covering the NFC mobile payments environment. It starts by presenting technical aspects of NFC chips, including how the technology was developed and how NFC compares to other similar technologies. An explanation of the way NFC mobile payments work and a classification of these services is conducted based on previous literature on mobile services, followed by a section including current trends regarding market penetration of NFC enabled mobile devices and payment services. An overview of two U.S. based NFC mobile wallet services is then presented, covering the companies behind these initiatives and the present status of the selected

services. A section on criticism of NFC mobile payments, including accounts of payment method specialists who are skeptical of the technology, concludes chapter 2.

As a result of literature review, Chapter 3 brings together some of the consumer behavior theories that are considered relevant for the development of the paper. The following theories are presented: Multi-attribute Models, The Theory of Reasoned Action (TRA), the Theory of Planned Behavior (TPB), the Technology Acceptance Model (TAM) and an extension of the TAM called the Technology Acceptance Model for Mobile Services (TAMMS). An explanation and overview of these theories is conducted and presented in a manner that can be easily understood even by readers that are not yet familiar with the consumer behavior field.

The development of the model is presented in chapter 4. The first section of the chapter deals with the theories presented in chapter 3 applying them to the context of NFC mobile wallets. It explains some of the stages of the consumer adoption process in the proposed model. Next, the drivers of intention to use NFC mobile payments are defined based on two meta-analyses of mobile payment adoption literature and studies on traditional payment method usage and acceptance. The model proposed by the author is then presented based on the information contained in the first two sections of chapter 4. An in-depth study of the constructs defined by the model, as well as the hypotheses which regards the relationships between these constructs, are covered in the remaining sections of chapter 4.

In chapter 5, the methodology for the validation of the hypotheses presented in chapter 4 is conducted. An explanation of a suggested subject population, that fits certain criteria for NFC mobile wallets adoption is given. The author makes an initial draft of a survey that could be conducted to gather data on consumers' opinions towards the hypotheses proposed by the study. The measurement and analysis of the survey data is briefly covered and a few data analysis techniques are suggested.

Although the model is yet to be empirically validated, an overview of the managerial implications of each hypothesis, in the case they are validated, is conducted in chapter 6. For each of the hypotheses a few scenarios are presented covering the implications for managers, this section is mainly directed to managers who are in charge of product development and marketing efforts.

2. Near Field Communication (NFC) Payments

2.1 The NFC Technology

NFC is a data exchange protocol based on the popular Radio Frequency Identification (RFID) technology. RFID has been widely used in logistics, especially in retail to track stock, sales and orders (Want, 2006; Patauner et al., 2007). Both are based on the same technological principles and make use of radio signals to communicate. Near Field Communication (NFC) technology allows smartphones and similar NFC enabled devices to read and exchange information between each other through a short-range (up to 10 cm) wireless connection (Falke et al., 2007); it works in the frequency band of 13.56 MHz following the ISO/IEC 18092:2004 standard. NFC chips can either be powered or unpowered. Data can be retrieved from unpowered NFC chips, also known as “tags”. Tags are usually read-only but can also be rewritable (NFC Forum, 2012a).

The main difference between NFC and RFID is in the range (the distance in which communication is possible) and type of communication supported. Depending on the type of tag and reader, RFID’s range can reach over 120 meters (RFID.net, 2012). Two components constitute an RFID system, the transceiver, also known as a read-write-device or simply reader or writer, depending on the functionality, and a transponder or tag, which consist of an antenna and a data storage microchip (Falke et al., 2007; Bravo et al., 2008).

While classical RFID systems use only one read-write device attached to a computer, thus operating in a passive mode, NFC systems are able to operate in both passive and active modes; both devices can be active and generate their own field of radio frequency to transmit data (peer to peer), it is also possible to operate passively with only one of the devices generating radiofrequency fields with the other being used to load modulation for data transfers (Falke et al., 2007; Bravo et al., 2008).

The mobile interactions that are made possible by the use of NFC technology are presented on Figure 1. The NFC enabled device can read the information stored in a tag (Figure 1a), have its data retrieved by a reader (Figure 2b), or establish a direct connection with other NFC devices (Figure 3c) (Falke et al., 2007).

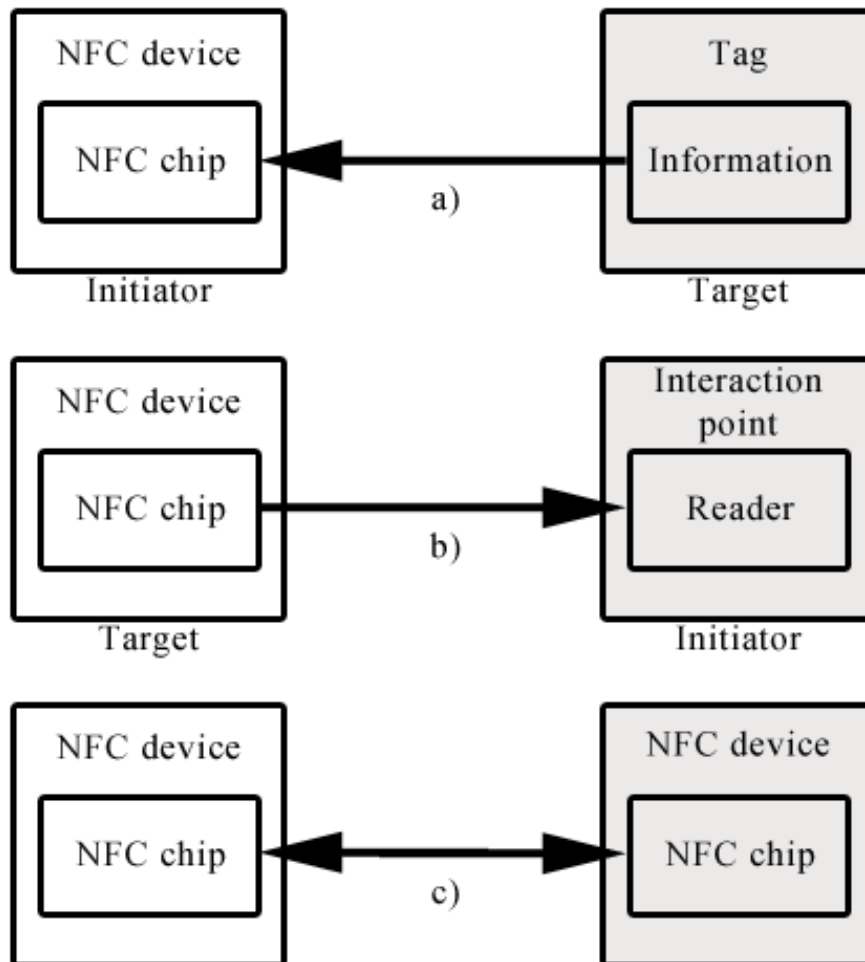

Figure 1: Types of interaction supported by NFC

The NFC standard has been designed to use support structures that are already in place, the technology is also highly compatible with other identification technologies such as the ISO 159693 RFID tags (operating in the 13.56 MHz frequency) and the FeliCa and Mifare smart card standards (Falke et al., 2007).

One of the most praised features of NFC devices is that there is no need for configuration or pairing as in the case of other wireless technologies such as Bluetooth or Wifi. When NFC devices are located near to each other, they seamlessly connect and can trigger specific tasks automatically, such as opening a mobile application (Dodson and Lam, 2011).

There are countless examples of possible usages of NFC enabled smartphones, referred to as *micro-interactions*, ranging from gaming to controlling home appliances (Massoth and Bingel, 2009; Dodson and Lam, 2011). NFC has been referred to as the ideal technology for mobile payments (Chen et al., 2011).

2.2 NFC Mobile Payments

As a result of this short-range information exchange characteristic, NFC has been praised over other data transfer technologies such as RFID and Bluetooth, as an optimal solution for low range mobile payments. The purchase process has also been compared to other available mobile payment methods and was found to be more efficient in regards to speed, security and usability (Massoth and Bingel, 2009). As mentioned earlier in the paper, NFC mobile wallets are a point-of-sale solution; the technology allows for payments in the location a purchase is being made, which could be a store or a self-service environment such as a vending machine.

Making a purchase using an NFC mobile wallet is similar to using a regular credit card. Payment information such as credit card, debit card or bank account numbers are stored in the smartphone. To make a purchase the user waves an NFC enabled device over a reader - no contact is needed, it is not rare to see publications refer to NFC mobile payments as contactless payments (Amoroso and Magnier-Watanabe, 2011; Madlmayr et al., 2008) - the payment information is then exchanged and the purchase data such as price and item description appears on the smartphone screen, the user verifies the order details, and if everything is correct, confirms the payment by entering a PIN and the purchase is made.

A report by the Smart Card Alliance (2007) presents some of the advantages NFC mobile payments may offer consumers, they are: *increased convenience, savings, and personalized assistance with their shopping and payment needs*. These advantages can be observed in several aspects of the purchase process. For example, NFC in-store payments remove the need for paper receipts; transactions are stored on the consumer's mobile phone. Payment transaction records can be accessible on a consumer's mobile phone or other devices. Credit cards, debit cards, prepaid, gift cards are all accessible from the smartphone interface providing users with a simple and unprecedented level of financial control and organization. The technology allows for personalized offers and the use of the smartphone as access card to fitness or other members-only clubs.

Another advantage of NFC mobile payment methods is regarding its implementation in retail locations, since it uses the financial payments processing infrastructure that currently supports credit, smart cards and other card based payment options (Smart Card Alliance, 2007).

2.2.1 Classification

First it is important to make a distinction between *NFC mobile payments* and *NFC mobile wallets*. An NFC mobile payment is any payment made using the NFC chip that is integrated in a mobile phone, while an NFC mobile wallet is a service that holds financial information such as credit cards and that utilizes NFC chip to exchange that data with purchase terminals. In other words, the NFC mobile wallet is a NFC mobile payment method, but not all NFC mobile payments are conducted through an NFC mobile wallet. This paper focuses on NFC mobile wallets.

In order to more accurately study NFC mobile payments, it is important to classify the service according to its characteristics. In general, mobile payments may be classified as *remote mobile payments* or *proximity mobile payments* (Smart Card Alliance, 2007). *Remote mobile payments* refer to payments where the transaction does not depend on geographical location, buying ringtones through SMS messages or making electronic purchases by visiting websites using the mobile device's web browser can be cited as examples of *remote mobile payments*. Since NFC mobile wallets are only capable of transferring data to other NFC devices when located in a short range, of a few centimeters, NFC mobile wallets are classified as a *proximity mobile payment* method.

Nysveen, Pedersen and Thorbjørnsen (2005), classify *remote mobile payments* as machine-interactive services. In the case of *NFC mobile payments*, the service can be, depending on the setting, classified as both, *human-interactive* and *machine-interactive*, for instance, when making the purchase of an item through a cashier the service will be dependant on human interaction, thus being *human-interactive*. When buying an item through a vending machine or other self-service setting the service can be said to be *machine-interactive*.

Although this might change in the future, NFC mobile payments methods are currently referred to as a C2B payment method (Delloite, 2012); customers use the service to purchase directly from businesses. It is also important to note that NFC mobile payments are not entirely web-based services; an Internet connection is needed to set-up the service, load it with the user's financial information and to add funds, but payments can be made even if no internet connection is available (Honig, 2011).

As with any other payment method, the purpose of using NFC mobile payments is completing a transaction, the service can then be classified as *goal-directed* (Nysveen,

Pedersen and Thorbjørnsen, 2005); instrumental orientation and utilitarian benefits are identified as strong characteristics of the service.

2.2.2 Current Adoption and Trends

Mobile devices have become a common item in people's lives; it is arguably the most widespread computing device in the world (Falke et al., 2007). The number of mobile subscriptions in 2011 reached 5.9 billion (International Telecommunication Union, 2011) and it is common knowledge that people don't leave home without their mobile devices (Smart Card Alliance, 2007). Although only a small fraction of the devices in use today are NFC enabled, it is clear that there's great opportunity for NFC mobile wallet services to grow.

Asia has been pioneering the use of NFC based payments. In Japan and Hong Kong, for instance, the use of NFC payments with mobile phones and smartcards for vending machines and public transportation has been a part of everyday life since 2004 (Paus, 2007; Graham, 2011; Dodson and Lam, 2011). Since 2003, US companies have trialed NFC payments without much success; some papers blame the number of stakeholders involved, and their lack of engagement in agreeing to a single standard, but some of the key infrastructure such as adoption of contactless card payments by credit card networks has already been deployed (Smart Card Alliance, 2007; Segan, 2011). Economic challenges for NFC mobile payments adoption, such as choice and demand, network externalities, switching costs and adoption diffusion should be similar to those faced by other payment methods that preceded it (Au and Kauffman, 2008).

Although only 1.3 percent of U.S customers had made an NFC mobile payment in 2009 (Foster et al., 2011), usage is expected to grow fast. According to Gartner, by 2015, 50 percent of the smartphones sold in the US will feature an NFC chip; Jeff Miles, the vice president of mobile transactions for NXP Semiconductors stated that NFC enabled devices should reach critical mass by 2014 (Thompson, 2012). Technology value chain research company iSuppli launched a forecasted that the numbers of mobile phones with integrated NFC capability that will be shipped in 2015 will surpass the 500 million units mark worldwide (Figure 2) (Rebello, 2011).

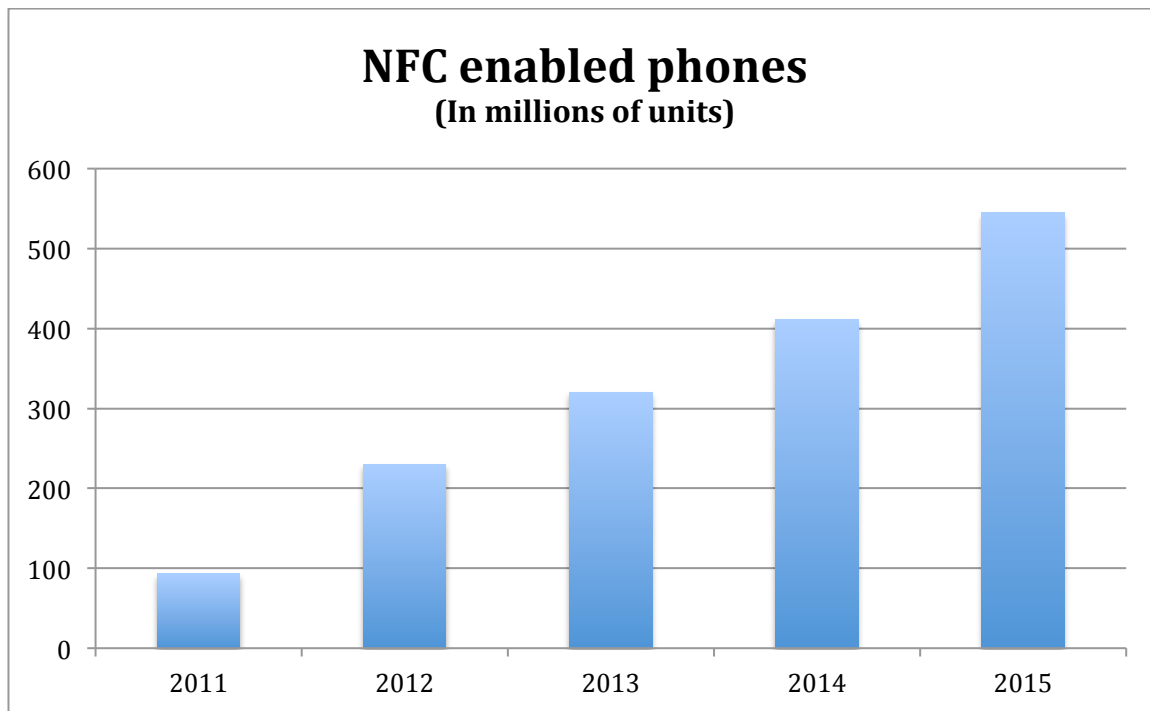

Figure 2: Worldwide forecast for mobile phones with integrated NFC capability

An association named the NFC forum was created to facilitate the adoption of the NFC technology. It aims at guaranteeing interoperability and maintaining standards to ensure that companies can include the technology in their products, consequently, increasing the adoption of the technology by manufacturers and consumers. The NFC forum has 160 + members, founding companies are NXP Semiconductors, Sony and Nokia (Chen et al, 2011; NFC Forum, 2012b).

As early as 2005, RFID contactless card services have been pushed in the market. The initiatives that are currently in use in the US include: ExpressPay by American Express, Discover Network ZipSM by Discover Network, payWave by Visa and PayPass by Mastercard. These services are either RFID or NFC based and have been successfully implemented (Smart Card Alliance, 2007). Since NFC mobile wallets are compatible with the current contactless payment infrastructure its adoption will face less entry barriers than other mobile payment options.

With the payment infrastructure in place and NFC becoming a standard mobile device technology, it is just a matter of time until NFC mobile payments are widely spread and adopted by consumers around the world. Juniper forecasts that 1 in 4 customers in the US and Western Europe will adopt NFC mobile payments by 2017 (Juniper Research, 2012).

2.3 An Overview of Current NFC Mobile Payment Services

In this section two U.S based NFC mobile wallet solutions are reviewed. The first is Google Wallet, arguably the most popular NFC mobile wallet service in the world. As the name says, it is an NFC enabled payment service developed by Google. The service is already being marketed and has been available to U.S. consumers since 2011.

On section 2.3.2, an ambitious initiative in the NFC mobile wallet market called ISIS is covered. ISIS is a joint venture formed by three major U.S. mobile phone carriers it also counts with the support of a large base of partners, which range from banks to credit card processors, the service will enter in test-phase on mid-2012.

As mentioned earlier, it appears that stakeholders cannot come into terms, there's a clear battle to see who will be the de facto provider of these services, and while everyone is trying to capitalize in the NFC mobile wallets market, users are still waiting for a service that will allow them to truly replace their plastic cards with their smartphones.

2.3.1 Google Wallet

Google has been constantly developing and acquiring mobile ventures. Their mobile services portfolio has grown considerably in the last few years and now features products such as AdMob, one of the world's largest advertising platform for mobile devices acquired by Google in 2009 for US\$750 million (Burrows, 2010), Android (the most popular mobile operating system) (Gartner, 2012) and Google Latitude (location based services) only to name a few. At a press conference in May 2011, Google demonstrated Google Wallet, their mobile payment solution, for the first time (Reardon, 2011). In September 2011, the Google Wallet app was made available for the public, with the promise of offering customers not only mobile payment options but also a wide range of payment related services (Sutter, 2011). Trials started in the U.S. but the company has plans for global expansion (Garvín, 2011).

Google Wallet users are able to store credit cards, gift cards, loyalty cards and other types of payment and promotional related information within the app. Paying is supposed to be very easy, just wave the phone on a PayPass terminal, enter a PIN number, if required, and tap to confirm. The service works at over 140,000 MasterCard PayPass merchant locations (Google Wallet, 2012a). In September 2011, Visa announced that Google had licensed

Visa's PayWave technology to use with Google Wallet, but not much has been made public about the deal since (McCarthy, 2011).

One of the main barriers Google Wallet is facing is the inability to offer users the option to add their current plastic cards information to their smartphones; at the moment it only supports Citi MasterCard credit cards that work where PayPass is available and a Google Prepaid Card, which can be funded with any credit card. Getting other payment processors such as Visa, Discover and Amex will pose a significant struggle since these brands are either developing mobile wallets of their own or have already partnered with other alternative mobile payment services.

The corporate stakeholders involved in the Google Wallet initiative are: Citi (issuing bank), MasterCard (payment processor), Sprint (mobile carrier), First Data (POS, merchant processing and trusted service manager), Verifone (POS), ViVOtech (POS), Hypercom (POS), Ingenico (POS) and NXP (NFC chip provider) (Google Wallet, 2012b).

Adoption of the service has been slow and it was reported that, in order to accelerate growth, the company might be considering alternatives such as revenue sharing with mobile carriers (Kharif, 2012). Some of the mentioned reasons for the slow adoption of the service include its current inability in providing a real replacement option for plastic cards, PayPass not being widely available as a payment option at retail locations and that it only works on a small number of mobile device models. Security concerns such as the service being vulnerable to attacks have also been reported (Caldwell, 2012).

2.3.2 ISIS

Three of the top telecom networks operators in the US - AT&T Mobility, T-Mobile USA and Verizon Wireless - that together account for the majority of US mobile subscribers (Garvín, 2011), joined forces to launch the ISIS mobile wallet service. Although the joint venture was first presented in 2010, the service is only planned to launch on a few selected test locations on summer 2012

ISIS is a well-coordinated initiative that has gathered the support of major payment processors, banking institutions and mobile phone manufacturers. Its proposal is similar to that of Google Wallet, following the premise that users should be able to replace their physical wallets and plastic cards with their mobile devices.

The service's current support base and consequently its infrastructure is arguably the best in the segment. ISIS supports all four major credit card processors: Visa, MasterCard, America Express and Discover. This will definitely come as a strong competitive advantage against other NFC mobile wallets, especially Google Wallet. The mobile device manufacturers that partnered with ISIS are HTC, LG, Motorola Mobility, RIM, Samsung Mobile and Sony Ericsson.

Differently from Google Wallet, ISIS is trying to establish itself in the US and hasn't mentioned plans for scaling the service globally (Garvín, 2011).

2.4 Criticism of NFC mobile payments

Despite the optimistic forecasts for adoption and the advantages of NFC for mobile payments, some companies are still skeptical regarding its widespread usage and doubt the disruptive potential of the technology. Although PayPal, the most popular Internet payment service in the world, has tested NFC mobile payments terminals in Sweden in 2011 (Rao, 2011), it has openly criticized the technology. Cameron McLean, managing director at PayPal UK, stated that: "mobile payments don't need NFC technology to succeed" (Telegraph, 2012). David Marcus, President at PayPal, said that NFC is a limited technology, and that the idea of switching a "swipe" for a "tap" is not very ambitious. He claims that having your wallet in the cloud and being able to pay for things, such as a dish at a restaurant, on the way there, and have it ready by the time you arrive, sounds more attractive than just maintaining the same POS purchase process (Donovan, 2012).

There's still a lot of apprehension in the market towards the acceptance of NFC mobile payments, some argue it is a costly alternative, a technology that would take small retailers up to ten years to fully embrace, and that other standards, such as the EMV (the Europay, MasterCard and Visa chip cards and terminals), are also available as an alternative to NFC (Donovan, 2012). Critics state that complex alliances between banks, software developers, mobile phone operators, handset makers and credit cards processors are needed to make the NFC mobile wallet system work. Not to mention the costs from the part of retailers to install NFC enabled POS terminals in their stores (Garside, 2012). Keith Rabois, the COO of mobile payment company Square, stated that NFC doesn't offer a value proposition to consumer or merchants (Fehrenbacher, 2011).

3. Theoretical Perspectives on the Adoption of Services

It is not yet clear whether NFC will become the de facto technology for in-store mobile payments or not, the use of mobile devices at the point-of-sale is yet to become a widespread activity. In this chapter relevant consumer behavior theories that serve as a basis for the development of this study are presented.

3.1 Multi-attribute Models

Multi-attribute models are based on the premise that customers are attracted by the characteristics of a good or service; not the goods or services themselves (Lancaster, 1966). It focuses on quantifying, explaining and ultimately predicting consumer's decision-making process. These models were developed with the purpose of answering questions to consumer behavior issues that economic literature could not respond, they focus on factors that influence choice and form *attitude* towards objects (Nelson, 1999). These factors are referred to as *attributes*, and it is posed that customers assign a weight or importance to each attribute. In marketing and consumer behavior studies, this attitude formation process is often covered in situations where the evaluation and selection of goods or services take place. Thus, simply put, the *attitude* of a person forms towards a brand or service is based on the information they possess regarding the *attributes* of each item being evaluated and how the consumer assesses those attributes (Nelson 1999). Consequently, the selected brand or service should be one that, according to the information the customer possesses, supports the greatest number of relevant attributes as compared to others.

Attribute-choice relation studies have been reviewed and compared to other consumer behavior models and shown to predict decision more accurately than some of its counterparts (Bettman, Capon and Lutz, 1975; Currim, 1984), these relations have been covered in several marketing areas such as consumer information environments (Johnson and Katrichis, 1988), attitude modeling (Wilkie et al., 1973) and choice modeling (Danes and Cattin 1980). Most of the multi-attribute models research takes into account physical aspects of products, which can be improved or modified by manufacturers, and focuses on how certain product attributes influence the purchase process.

Attributes are sometimes expected to be included in products and services by default, i.e. the keyboard on a computer. These “expected” attributes are often the same within a range of similar offers and do not influence selection. Multi-attribute models focus mainly on the attributes that make a difference when it comes to decision-making; they have been referred as *determinant*, *salient*, or simply *important* (Mittal et al., 1993). There are three types of multi-attribute models that attempt to explain the decision-making process based on different kinds of relation between *attributes*, *information* and *attitude* (Nelson, 1999).

The first - and simplest – type of model refers to attitude that is formed on the grounds of reasonable heuristics or 'rules of thumb', and is associated with low-effort/cost, ordinary purchase decisions (Nelson, 1999). Since information gathering takes time and effort, researching and comparing the attributes of every possible option in a certain choice-range is not worthwhile. For this type of purchases customers usually base their decisions on the first simple ‘satisfactory’ factors. For instance, when buying salt at a grocery store, a customer would simply compare the quantity and price of the available options without taking into account detailed brand or product characteristics.

The second set of multi-attribute models explicitly involve brand evaluation and are known as non-compensatory preference and choice models (Nelson, 1999). These models posit that customers prioritize certain attributes and that there’s no tradeoff between sets of attributes; non-satisfactory attributes will not be compensated by different attributes, even if they are satisfactory ones. There are two types of models that are based on this premise: *conjunctive* and *priority based*. *Conjunctive models* suggest that consumers evaluate products based on a pre-determined checklist of important attributes, and that these attributes are analyzed based on an acceptance level; if any attribute fails to meet the desired requirement, then it is dismissed. According to *priority-based models*, customers have a set of priorities, which are ordered from top to bottom. Brands that do not meet the top priority are eliminated; the remaining brands are checked for the second priority and so on. The consumer should be left with only one alternative at the end of the process, which will be the selected brand (Tversky, 1972).

Multi-attribute utility models, the third type of model covered in this chapter, posits that attributes are compensatory - there can be tradeoffs between attributes, but these are modeled, which requires extensive information gathering and processing (Nelson, 1999). While non-compensatory models suggest that customers would prefer to evaluate multiple

brands, without going in detail on specific attributes of each brand, compensatory models assume that consumers would prefer to have more in-depth information about fewer brands than superficial information on many. Thus, the consumer would select a limited number of brands to analyze and choose from (Nelson, 1999). Multi-attribute utility models are concerned with how consumers evaluate the attributes, but since there might be gaps in the accuracy of the information consumers have, expected utility, rather than utility modeling, is a term that describes the subject more precisely. Two functional forms of multi-attribute utility are generally used, the *linear* and *part worths* models (Nelson, 1999); the difference is in how they assess the importance and weight of each attributes.

Defining the set of attributes consumers consider the most relevant in a product or service is highly valuable for marketing and product development purposes. This is because the attributes are supposed to influence customers' attitude towards a product or service. An early and simple approach for multi-attribute attitude measurement can be found on Fishbein's (1963, cited by Bettman, Capon and Lutz, 1975) equation, *wherein an individual's beliefs about a particular attitude object are weighted and summed to yield an index of overall affect, or attitude*. This is arguably the most well known method to measure attitude. Researchers usually identify important product and service attributes through interviews, focus groups and past experience.

3.2 The Theory of Reasoned Action

According to Hale, Householder and Greene (2002) Fishbein and Ajzen developed the TRA out of discontentment with the lack of a consensus in literature towards the concept of attitude, and the divergent results in the ways it was measured. The TRA succeeded in creating a coherent structure in the study of attitudes and presenting a model that attempts to predict volitional behavior. Volitional behavior is any behavior that takes place through a conscious decision process, where the person has control on whether to perform it or not. The theory posits that *behavioral intention* is the best predictor of behavioral engagement (Hale, Householder and Greene, 2002). The model serves as a starting point for the theories presented hereafter in this paper. It deals specifically with behavior; neither outcomes nor the results of behaviors are covered (Sheppard, Hartwick, & Warshaw, 1988). For example, in the case of *jogging*, the TRA is interested in a person's *behavioral intention* towards going

outside to jog, it would not be concerned about the consequences of the activity, which might be getting fit or losing weight.

“The key application of the theory of reasoned action is prediction of behavioral intention, spanning predictions of attitude and predictions of behavior. The subsequent separation of behavioral intention from behavior allows for explanation of limiting factors on attitudinal influence” (Ajzen, 1980). The theory does not apply to behavior that is involuntary or that might be impulsive, spontaneous, habitual, the result of cravings, or simply scripted or mindless (Bentler & Speckart, 1979 and Langer, 1989, as cited by Hale, Householder and Greene, 2002). Behavior that requires special skills, unique opportunities or the help of others is also excluded from the theory because it doesn’t allow for complete volitional control (Liska, 1984).

As stated previously, the most efficient way to predict engagement in volitional behavior is by studying *behavioral intention*. Years of studies using the TRA have been the subject of meta-analyses and it was observed that the TRA propositions are valid (Sheppard, Hartwick, & Warshaw, 1988). If a person is inclined to perform a behavior, and they have all the means necessary to perform it, this should serve as evidence that they will, most likely, engage in said behavior. The theory focuses on defining the factors that influence the development of a positive or negative *attitude* towards the intent to engage in certain behavior and how those factors can be measured. The main elements of the model are *behavioral intention*, *attitude* and *subjective norm*. Detailed information on these constructs will be presented in the upcoming sections.

3.2.1 Behavioral intentions, attitude and subjective norm

Fishbein and Ajzen (1975) have proposed that behavioral intentions are the direct result of the attitude towards the behavior and subjective norms related to the behavior. Attitudes have an intrinsic nature, it is how individuals evaluate behaviors and how they feel regarding engaging in a given behavior. Hence, attitude relates to the degree to which a person considers a behavior to be positive or negative, this is basically a personal opinion regarding a behavior. Subjective norms are based on the perception of how other members of one’s social circle expect an individual to act towards performing the behavior. In the TRA, weights are assigned to both attitudes and subjective norms, the sum of these weights will determine the degree of behavioral intention, and consequently, whether engaging in a

certain behavior is likely to occur. In its most simple form the TRA can be expressed by the following mathematical function:

$$BI = (AB)W_1 + (SN)W_2$$

BI represents the Behavioral Intention; AB is the Attitude towards the behavior and SN the subjective norm. Both W 's represent the weight measure given to each element of the function. The framework for the TRA can be observed on Figure 3:

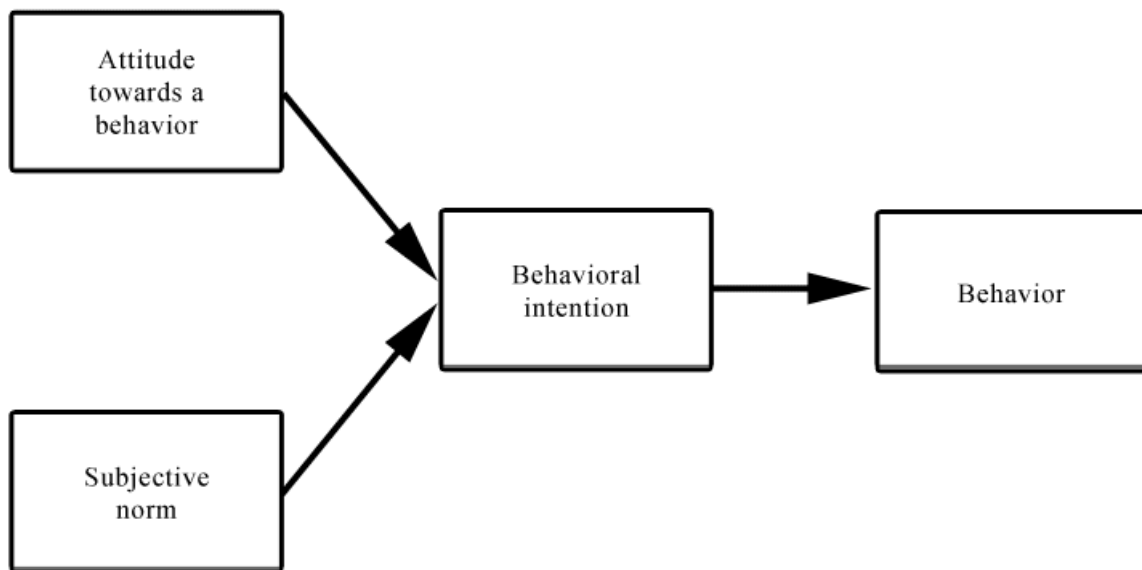

Figure 3: The Theory of Reasoned Action Framework

In sum, according to the TRA, engaging in volitional behavior is a direct result of behavioral intention. Behavioral intention is determined by the attitude towards the behavior and the subjective norms associated with the behavior.

Using the TRA's premises in campaigns, which aim at shaping or influencing consumer behavior, would then result in evaluating and, consequently, targeting the attitudes and subjective norms which are related to behavioral intention (Hale, Householder and Greene, 2002). In order to precisely define how behavioral intention is formed it is helpful to analyze the elements that constitute attitude and subjective norms.

3.2.2 Belief Strength and Belief Evaluation

According to the TRA's conceptual framework, beliefs and attitude towards an object are acquired simultaneously (Fishbein and Ajzen, 1975). In 1967, a few years prior to releasing the TRA, Fishbein published a Summative Model of Attitude, a study that served as a basis to define what attitudes are and how they are formed (Fishbein, 1967a and 1967 b, as cited by Hale, Householder and Greene, 2002). The Summative Model of Attitude posits that attitudes are the resulting sum of *belief strength* and *belief evaluation*.

Beliefs are often described as a link between an attribute and a volitional behavior or attitude (Hale, Householder and Greene, 2002). For instance, when someone believes that “making payments with a smartphone is safer than using a credit card”, this belief links an attribute (reducing risk) to a behavior (paying with a smartphone). *Belief strength* is how strongly one believes that a certain attribute is linked to a behavior, or how a behavior may lead to a certain outcome (Fishbein and Ajzen, 1975). *Belief evaluation* is whether the belief has a positive or negative effect towards the behavior, thus shaping attitude. In the context of attitude formation, the elements mentioned above can be expressed with the following mathematical formula:

$$A_B = \sum b_i e_i$$

Where A_B is the attitude towards the behavior, which is a result of the sum of b , that represents *belief strength* and e , the *belief evaluation* variable.

There are differences in the degree each belief has on attitude; it is valid to point the concept of *belief salience* (Fishbein and Ajzen, 1975). A person may hold a large number of beliefs towards an object, but since the information processing capacity of the human brain is limited, a complete evaluation of every belief towards an object is impossible, thus only a few beliefs will influence attitude at any given time. Beliefs that have an effect on attitude are called *salient beliefs*.

3.2.3 Normative Beliefs and Motivation to Comply

As covered previously, subjective norms reflect the social environment and how it influences behavioral intention. Similarly to how *belief strength* and *belief evaluation* affect attitude, a

function composed of two variables influence subjective norms, they are: *normative beliefs* and *motivation to comply*, which can be expressed by the following formula:

$$SN = \sum b_i m_i$$

Where SN is the *social norm*, a value determined by the result of the sum of *b* the *normative belief* and *m* the *motivation to comply*.

Humans are social beings, and as such, take into consideration what others think about them; through the cognitive process of deciding upon engaging in a certain behavior, the perceived expectation of others towards the behavior is rationalized, affecting one's own opinion on whether to engage in the behavior or not. This perceived expectation of others towards the behavior is what researchers define as *normative belief*. There are different levels of perceived expectation; in some cases the opinion of others towards a behavior is irrelevant, while in other situations it may be the main reason for engagement. *Motivation to comply* relates to the level of pressure one feels from others, and to what extent this pressure influences behavior.

When the concepts of *belief strength*, *belief evaluation*, *normative belief* and *motivation to comply* are included to the TRA, the following causal framework (Figure 4) is formed:

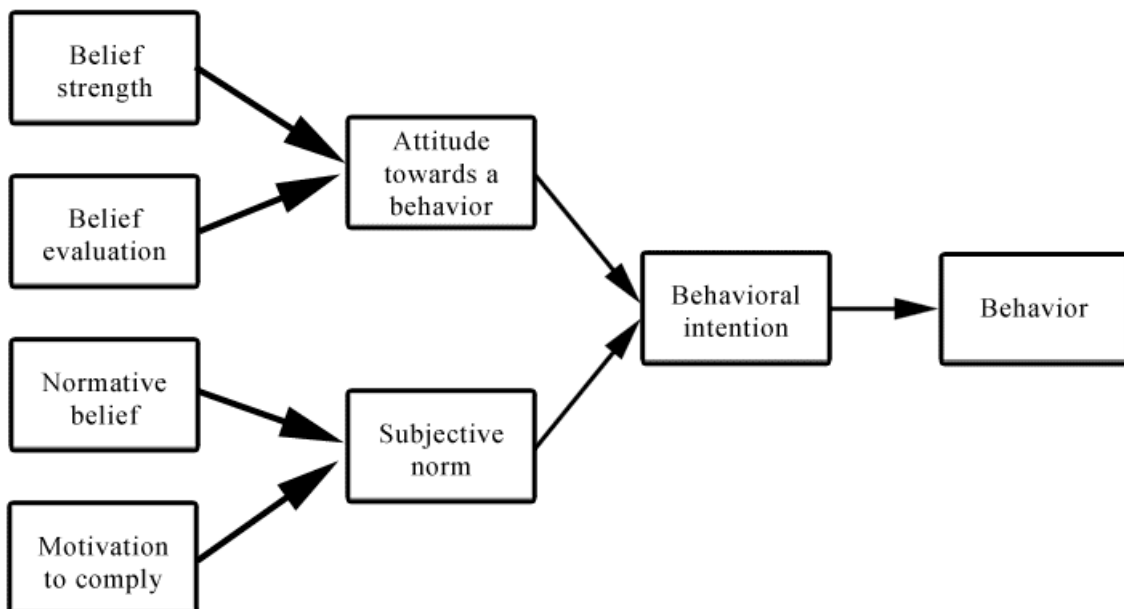

Figure 4: The TRA including the elements that form attitude and subjective norm

Variations of the TRA can be found throughout literature, authors often add unique determinants related to the behaviors they are researching. Meta-analysis of the model has found the predictive utility of the model to be quite strong (Sheppard, Hartwick, & Warshaw, 1988).

3.3 The Theory of Planned Behavior (TPB)

In situations where no obstacles to volitional control are found, behavior can be predicted quite accurately from intention (Sheppard, Hartwick, & Warshaw, 1988), but sometimes obstacles are presented and engaging in behaviors may require a few pre-conditions to be met. The Theory of Planned Behavior (TPB) presents the concept of *perceived behavioral control*. This theory is an extension of the TRA that was developed as a response towards the TRA's limitation on dealing with behavior over which people have incomplete volitional control (Ajzen, 1991). The elements of the TRA (*attitude and subjective norms*) covered in section 3.2 of this paper remain unaltered; *perceived behavioral control* is included as an additional factor that affects *behavioral intention* and *behavior*. *Perceived behavioral control* is summarized as how difficult or ease a person assumes performing a behavior may be; this perception is often based on previous experience, forecasted barriers and information from others (Ajzen, 1991).

“Although intention may indicate willingness to perform a behavior, it is important to note that certain behaviors depend on non-motivational factors such as the availability of requisite opportunities and resources like money, time, skills and others” (Ajzen, 1985). Consequently, when individuals have the intention and meet the requirements (opportunities and resources) to perform a behavior, they will succeed in it. Being in control of the necessary opportunities and resources to engage in a certain behavior is relevant, but the TPB is more concerned with the individual's perception of said control and its impact on intention and actions.

In order to define *perceived behavioral control*, Ajzen (1991) borrows from various concepts of behavioral control in literature. He cites Atkinson's *theory of achievement motivation* (1964), where perceived control is defined as the extent to which a person believes performing a behavior will result in a desired or expected outcome. Ajzen (1991) states that his definition of *perceived behavioral control*, as presented in the TPB, is more closely related to Bandura's (1982) concept of *perceived self-efficacy* which is concerned with

judgments of how well one can execute the courses of action required to deal with prospective situations. According to research confidence in the ability to perform a behavior influences behavior (Ajzen, 1991). Figure 5 illustrates how the concept of *perceived behavioral control* fits into the TRA framework.

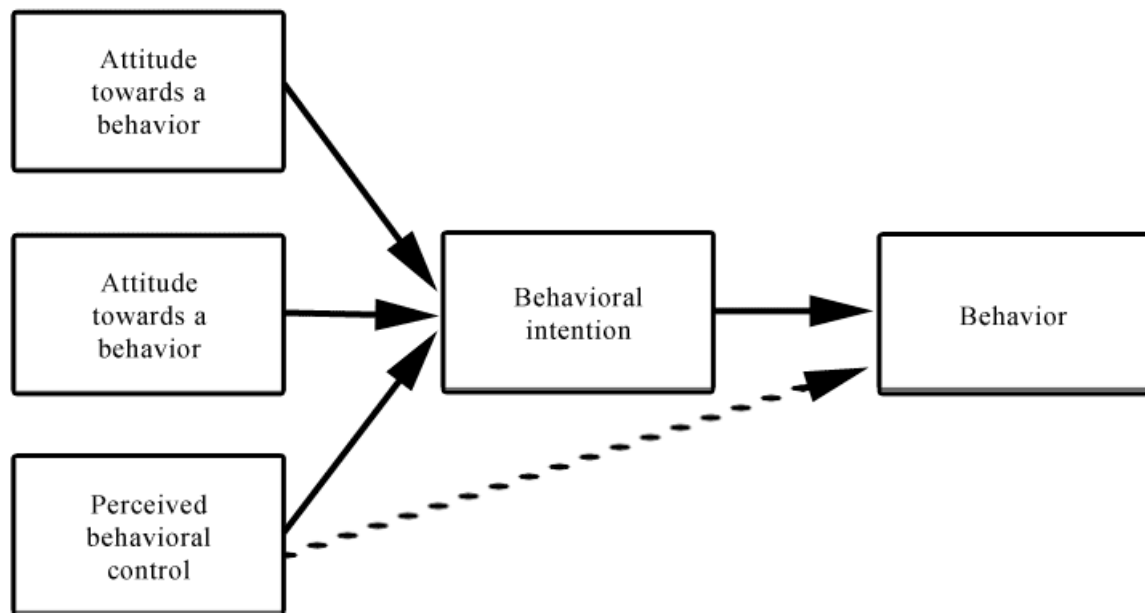

Figure 5: The Theory of Planned Behavior

The TPB hypothesizes that behavioral achievement can be predicted by analyzing *perceived behavioral control* in conjunction with *behavioral intention*. To explain the relevancy of *perceived behavioral control* the theory suggests that, when holding intention constant, the level of *perceived behavioral control* will influence individuals' willingness to perform a certain behavior. Nevertheless, perceived behavioral control will only count as a relevant predictor of successful behavioral attempt if the perception is on a par with reality; *perceived requirements and resources* should match those that are actually necessary to perform the behavior (Ajzen, 1985). There are two conditions that need to be met in order to accurately study and assess a subject's perceived behavioral control and intentions. First, the environment and context of the behavior, as well as the behavior itself, should be clearly defined, and secondly, environmental and contextual factors should not change in the time between assessing and observing perceived behavioral control and behavioral intentions.

Similarly to how *attitudes* are a result of beliefs towards a certain behavior and *social norms* the result of normative beliefs and motivation to comply, *perceived behavioral control* is constituted by two factors: *beliefs about resources and opportunities* or *control beliefs* and the *perceived power* of each control belief towards the behavior. *Control beliefs* refer to the presence or absence of requisite resources and opportunities necessary to perform the behavior. This is constituted by what a person perceives as the requirements to engage in a behavior, and if the person is in possession of the necessary requirements or not. While *perceived power* is to what extent the *control beliefs* the person holds will facilitate in engaging in a behavior. The relation between these variables and *perceived behavioral control* can be represented by the following mathematical expression:

$$PBC = \sum c_i p_i$$

PBC represents *perceived behavioral control*; which is a result of the sum of the *control beliefs* (c) and the *perceived power* (p).

Literature regarding the application of the TRA and TPB is abundant. The efficacy of the TPB in predicting behavior and intention has been confirmed by meta-analyses of its usage in a large sample of domains (Notani, 1998; Armitage and Conner, 2001). It is worthy to note that studies results have been inconsistent in their assessment of pair-wise relations featuring perceived behavioral control, and that moderators of perceived behavioral control such as demographic samples and the subjects' familiarity or unfamiliarity with the behavior may account for divergence in predictive results (Notani, 1998). Researchers should also be careful as to how they identify and present salient beliefs to respondents, the questions should truly reflect the object that is being measure, since wording may influence how subjects respond to questionnaires (Sutton et al., 2003).

3.4 Technology Acceptance Model

Widely applied in Information Systems (IS) research, the Technology Acceptance Model (TAM) started with a focus on end-user systems in organizational settings, with the original purpose of developing techniques for “enabling practitioners to, assess the impact of one class of managerially controllable variables, system characteristics, on the motivation of members of the intended user community to accept and use new end-user information systems” (Davis, 1986).

Created as an extension of the TRA, the original model by Davis (1986) maintains *attitude* towards behavior and *behavioral intention* as key elements of technology adoption, but excludes *subjective norms*. In the model, attitude towards using a system is a major determinant of actual usage (Davis, 1986). Davis (1986) justifies the removal of *subjective norms* by explaining that the TAM was developed for laboratory-based user acceptance tests, and that *subjective norms* shouldn't influence individuals in those settings, but affirms that this construct may represent a source of increased explanatory power if included.

The main elements of the TAM are *perceived ease of use* and *perceived usefulness*. These two constructs are presented as determinants that pose an influence on user's intention to adopt technology. Davis (1989) suggests that "a system high in perceived usefulness, is one for which a user believes in the existence of a positive use-performance relationship" and "all else being equal, an application perceived to be easier to use than another is more likely to be accepted by users". The perceptions regarding these two elements are based on attitudes, previous experiences and other personal characteristics that are unique to the user (Kaasinen, 2005).

Throughout time, a few revised versions of the TAM have been presented, most notably the TAM2, (Venkatesh and Davis, 2000), which reassesses the usage of *subjective norms*, and the Unified Theory of Acceptance and Use of Technology (Venkatesh et al., 2003). However, the original TAM is still one of the most used models in IS, partly because of its simplicity and understandability (King and He, 2006).

Usefulness is comprised of items relating to effectiveness, job productivity and other aspects related to work, as proposed by Davis (1989). Thus, the major effect of ease of use is through usefulness rather than directly on behavioral intention. This indicates the importance of perceived usefulness as a predictive variable. If a researcher decides upon measuring only one of the two independent variables, perceived usefulness would clearly be the one to choose.

Meta-analyses has concluded that the TAM is a powerful and robust predictive model; widely tested and consistently proven to yield statistically reliable data (Legris et al., 2003; King and He, 2006). It has been extended and applied to study the adoption of a large variety of technologies, such as virtual reality (Bertrand and Bouchard, 2008), eCommerce (Pavlou, 2003) and mobile services (Kaasinen, 2005). Despite its popular application in consumer

behavior research, Legris et al. (2003) has shown that, researchers often use incomplete versions of the TAM and omit attitude and/or behavioral intention from their studies. Figure 6 illustrates the TAM framework:

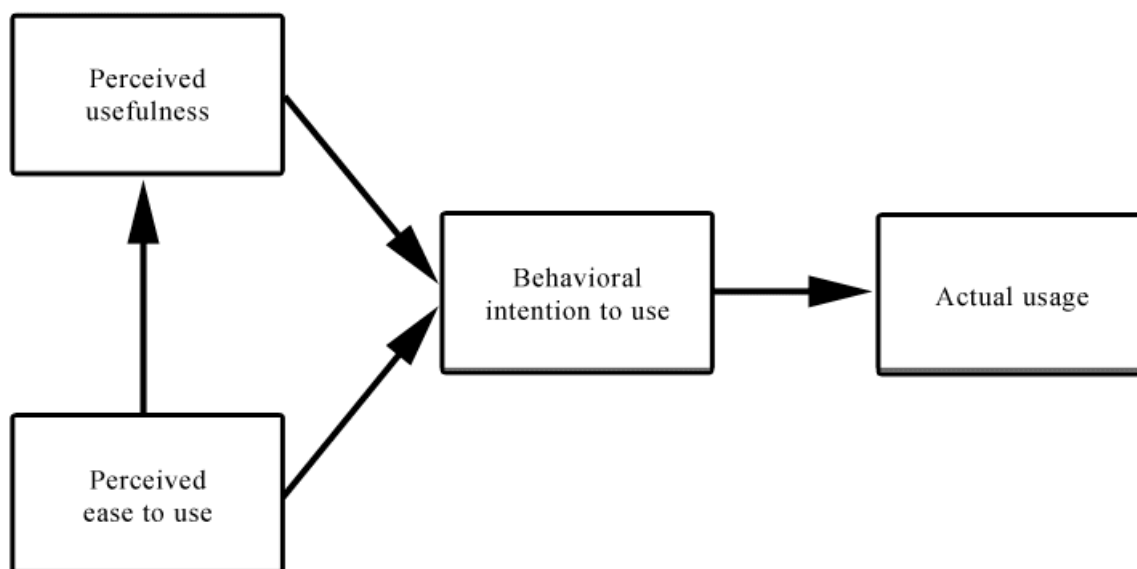

Figure 6: The Technology Acceptance Model Framework

Although *perceived usefulness*, *perceived ease of use* and *behavioral intention* are highly reliable constructs which have been empirically proven to successfully predict system use 40% of the time and that can be used in a variety of contexts (Legris et al., 2003; King and He, 2006), there are still a few remarks regarding the efficiency of the TAM.

The results of the TAM's predictions vary greatly depending on the types of users and to what system it is applied (King and He, 2006), in these cases, moderating variables may be needed to explain divergence in results. For instance, it has been observed that behavioral intention is heavily influenced by perceived usefulness, with perceived ease of use only affecting it mildly, but that's not the case in the context of Internet usage, where the influence of ease of use on behavioral intention has been significant, with King and He (2006) suggesting that Internet study results should not be generalized to other contexts and vice versa.

Since this paper deals with NFC mobile wallets, a payment system that is reliant on new technology, the development of the proposed model is heavily based on the observations and reasoning behind the constructs that are part of the original TAM and one of its extensions,

the TAM for Mobile Services (TAMMS), which serves as the main theoretical basis for the study. The TAMMS is covered in the next section 3.5.

3.5 The Technology Acceptance Model for Mobile Services

Although this paper borrows from several extensions of the TAM, the most used extension in our study of the adoption of NFC mobile wallets is the *Technology Acceptance Model for Mobile Services* (TAMMS) (Kaasinen, 2005). After reviewing consumer behavior literature, the author believes this is possibly the best model to derive the proposed study from.

Developed by analyzing and synthesizing the results of a series of case studies, this extension is constituted by four variations of the elements found in the original TAM that determine user acceptance of technology. Differently from most consumer behavior research involving the TAM, where hypothesis are suggested and then validated through empirical research, the elements of the TAMMS were defined according to the results of a series of case studies where human-centred design (ISO 13407:1999) cycles for the development of mobile services were used.

Human-centered design is a process that depends on the involvement of users so that product and service developers can fully understand the user and task requirements (Maguire, 2011). In summary, the design process works as a continuous feedback loop where subjects are presented with mobile service prototypes. The subjects engage in the usage of said services and researchers start to take notes of the interaction. Once the user-testing phase is conducted and researchers are done observing usage, feedback from the users on the positive and negative points of the service is gathered. The data regarding this initial testing is analyzed and a few observations are made, the resulting information is then sent to the programmers and designers developing the service. These professionals will attempt to implement the changes needed and create a second prototype of the service based on user's input. Once completed, another set of subjects is then exposed to the improved prototype, starting the human-centric design approach once again. Such process will continue until an useful and easy to use product is ready.

A framework which illustrates how these development cycles are constituted can be observed in Figure 7:

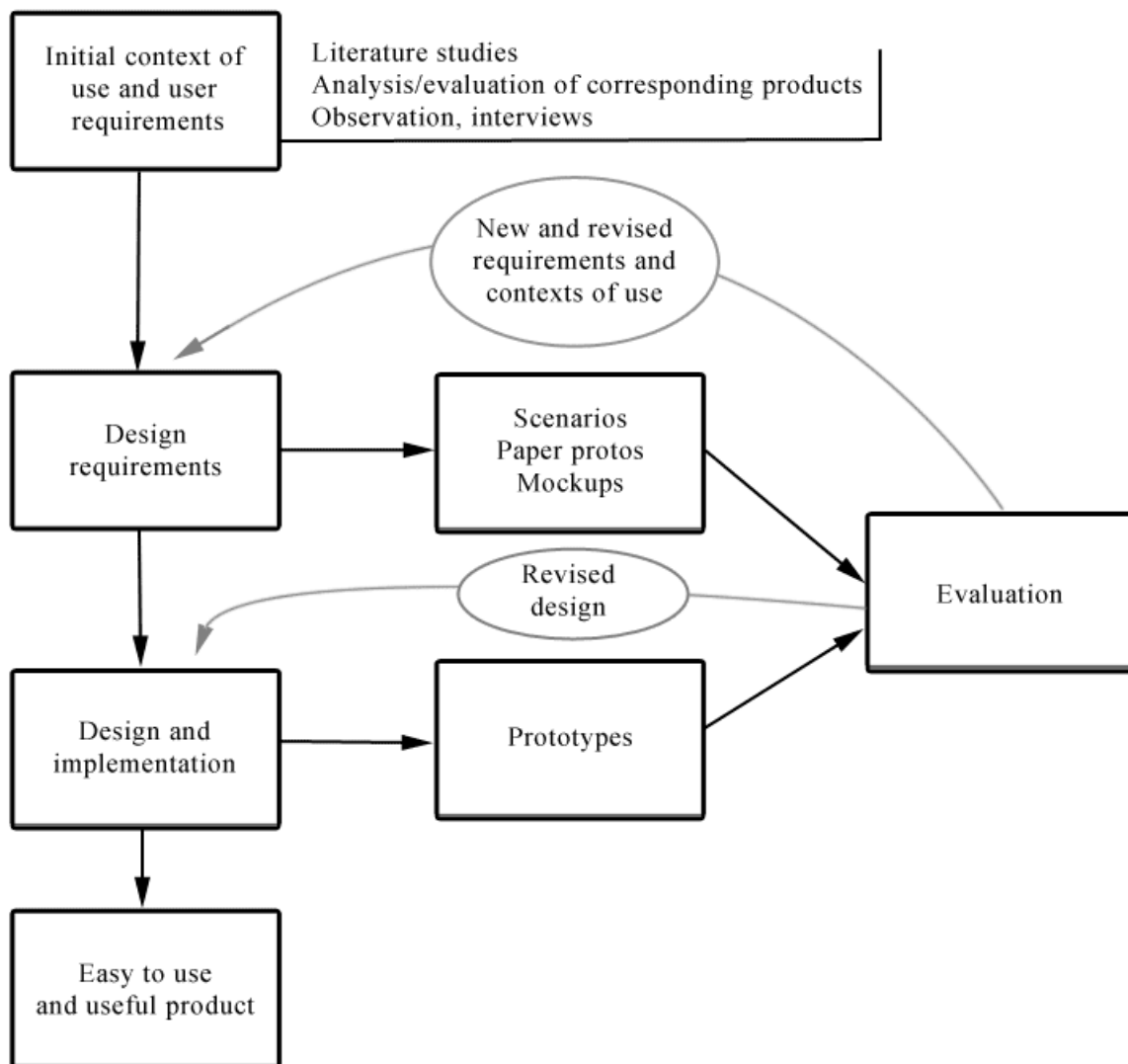

Figure 7: Human-centered Design

Based on the results of the studies conducted in the TAMMS, Kaasinen (2005) suggests three elements that pertain to the intention to use mobile services, they are: *perceived value of the service*, *perceived ease of use* and *trust*. A fourth element, *perceived ease of adoption*, assumed to be essential to get users from intention-to-use to actual usage is presented. Although the TAM for Mobile Services is focused on mobile Internet services and location-aware information services targeted for consumer use, the author of this paper hypothesizes that most of its determinants can be applied to NFC mobile wallet applications. NFC mobile payments in general, as covered previously in Chapter 2.2.1, might not be classified as

services that fall in the categories the TAMMS is supposed to cover since they are not entirely Internet based services (an internet connection is not always required), and even though it can, at times, possess location-aware characteristics, they are not classified as location services.

According to Kaasinen (2005), mobile service providers shouldn't focus on a wide range of useful features but on value. In the TAMMS, the *perceived value* construct replaces *perceived usefulness*; the model suggests that perceived usefulness may not address motivation to acquire mobile services in a satisfactory manner. It argues that key features of a product, which are appreciated and make users interested, are defined by value. Values can be determined by identifying goals through statements of what the user wants to achieve. Knowing the perceived value of the service allows providers to differentiate features by importance and focus on improving the ones that add to the user experience. According to Sutherland (2011), people believe that, if a service specializes in one feature, it is regarded as a better provider than a competitor that might offers the same service and many others together. Take Google vs. Yahoo as an example; Google is solely a search engine while Yahoo offers a portal. This is based on the principle of goal-dilution proposed by Fishbach, Zhang and Kruglanski (2007), "whereby increasing the number of goals that a single means can satisfy reduces the perception of its instrumentality with respect to each goal".

The concept of *perceived ease of use* applied to mobile services covers usability (navigation on a small screen device) and user experience; users value intuitive services where relevant tailored personal and contextual information is easy to access without the need for repetitive user information input or unnecessary effort. Initially, it is influenced by users' pre-conceptions and attitudes towards technology in general; these factors are gradually molded once usage takes place. The TAMMS uses the same definition of perceived ease of use as Davis (1989): "the degree to which a person believes that using a particular system would be free from effort". The usability and user experience of mobile devices has improved tremendously with the evolution of touchscreen systems and mobile broadband internet connections, hindering many of the previous limitations of usage and favoring *perceived ease of use*.

The original TAM by Davis (1989) was developed for organizational settings, where the users were familiar with the stakeholders that had access to the information input, resulting in considerable trust towards interaction. In the context of mobile services, trust has been

proposed as an important element of acceptance; service providers may be unfamiliar to users and in many cases a considerable amount of personal information is required in order to interact with the services. The TAMMS utilizes a definition of trust by Fogg and Tseng (1999, as cited by Kaasinen, 2005) whereas trust is “an indicator of a positive belief about the perceived reliability of, dependability of, and confidence in a person, object or process”. In the context of mobile services, privacy and security becomes an issue that influences acceptance. Trust, as proposed by the TAMMS, covers the perceived reliability of the service and technology, as to how stable it is under usage situations and control over personal data.

Perceived ease of adoption takes place between the *intention to use* and *actual usage*. It refers to how easy taking the service into use is perceived to be. This element is not relevant in settings where systems or services are pre-installed, such as in organizational environments. It is common for service developers to overview this part of the adoption process during pre-launch trials and prospect interviews, since the service is often presented to subjects in a state where usage can start right away. The interviews conducted through the case studies in the TAMMS has found that being unaware of where to find mobile services or how to take them into use posed as a barrier for adoption (Kaasinen, 2005). Prior to being able to utilize a mobile application or service, users often have to follow a few steps, which may include: understanding the marketing message, searching for the application, installing the application, setting it up and, finally, using it. Figure 8 presents the TAMMS framework:

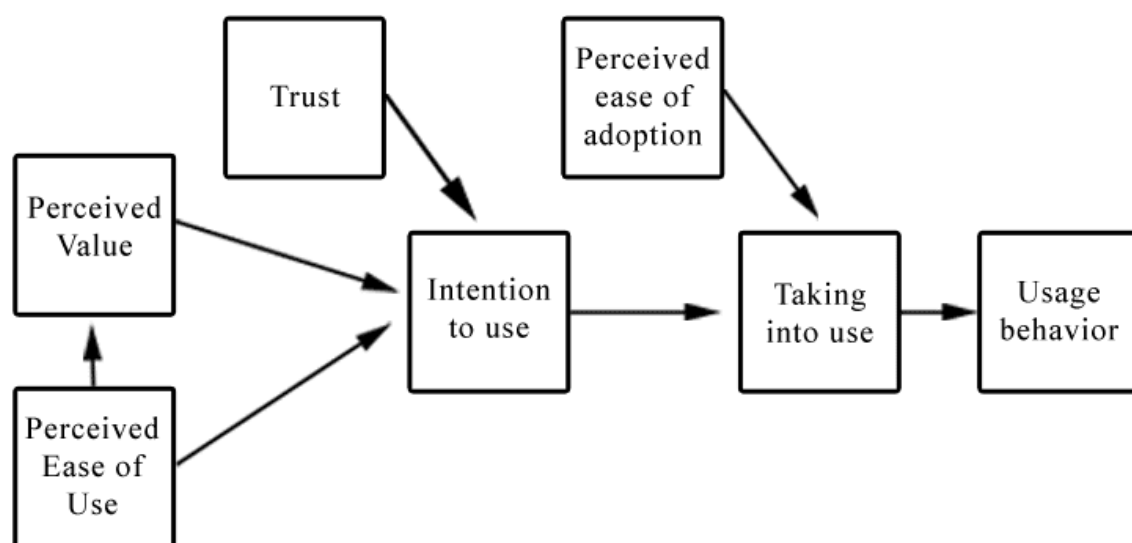

Figure 8: The Technology Acceptance Model for Mobile Services

4. Model Development

Consumer behavior literature, most notably the theories we have covered, provides a solid foundation that has aided countless researchers in defining behavioral formation and the antecedents to consumer adoption of a wide variety of technology. This chapter explains the reasoning behind the development of the model that attempts to explain the antecedents of adoption of NFC mobile wallets, including theoretical application and the selection of relevant constructs.

4.1 Theory in the context of NFC mobile wallets

NFC mobile wallets are services highly dependent on technology, for this reason, the TAM and the TAMMS appear to be the most adequate theories to develop the present research. However, instead of solely applying existing theories, or its extensions, to NFC mobile wallets, this study attempts to create a unique framework, one that takes into account exclusive elements of the services and technology.

The model should result in a better understanding of the antecedents of consumer adoption for this novel mobile payment solution. The main focus and end-point to the model's framework is the act of making a POS purchase with a smartphone; engaging in the usage of NFC mobile payments (behavior). Similarly to the TAM for Mobile Services, our model hypothesizes that the usage of NFC mobile wallets is preceded by *intention to use* and *perceived ease of adoption*.

To facilitate the understanding of the paper it is important to explain a few of the differences between, *intention to use* and *adoption* in the context of NFC mobile wallets. Further clarification is provided throughout the paper.

Based on the theories covered in chapter 3, *intention to use* NFC mobile wallets should be a result of the *attitude* towards the usage of NFC mobile wallets, which in turn is a result of *beliefs* towards usage. The TAM presents two *beliefs* for technology adoption: *perceived ease of use* and *perceived usefulness*. The TAMMS substitutes *perceived usefulness* with *perceived value*, also adding *trust* as an important construct of *intention to use*. For the purpose of this paper, drivers for intention contained in the TAMMS are included. *Intention to use* is the main predictor of actual usage; all other things held constant, if a potential user

has a positive attitude towards the use of NFC mobile wallets, he/she is more inclined to engage in usage.

Adoption is a one-time process that occurs between *intention to use* the service and taking it into use: it is logical to assume that customers are required to adopt the technology prior to usage. In the context of this paper it refers to actions regarding the *installation* and *set-up* of the NFC mobile wallets service. It may also include basic requirements such as the need to possess an NFC enabled mobile device and a bank account, but for all practical reasons, an assumption that the users fulfill the basic required conditions for adoption is made. Thus, *perceived ease of adoption* refers to the degree to which a user believes that installing and setting-up the NFC mobile wallet is free from effort. Once the customer has adopted the payment method he can move from intention to usage.

Here's a possible scenario exemplifying how *intention to use* and *adoption* may occur for NFC mobile wallets:

Suppose a consumer has read a piece on NFC mobile wallets in the newspaper. The article praised the security, ease of use and convenience aspects of the technology, painting a positive picture regarding its usage. The information presented in the article successfully creates a positive attitude towards the payment method; to the point where the consumer now has the intention to use it. But before being able to go to the store and buy something with his smartphone, the user first has to install the NFC mobile wallet application and set it up. He searches for the application on an application marketplace or website, downloads the NFC payment wallet to his mobile device, adds some personal and financial information to the service and is ready to take it into use.

4.2 Drivers of intention to use NFC mobile wallets

Utilizing the determinants from Kaasinen's TAMMS, this paper maintains *perceived value*, *perceived ease of use* and *trust* as the elements behind intention to use NFC mobile payments. In the next paragraphs an overview of the criteria selection process and an attempt to determine the attributes that shape how consumers define those elements is conducted.

Most of the theoretical foundations and modal constructs that support the NFC mobile payments adoption framework were borrowed from studies where the TAM was applied

either to traditional payment services (Plouffe, Hulland and Vandenbosch, 2001), web services (Lederer et al., 2000; Chen and Hitt, 2002; Koufaris, 2002) and mobile services (Wu and Wang, 2005; Kaasinen, 2005; Stalfors and Nykvist, 2011). Furthermore, the topics reviewed for the development of our model include: consumer behavior theory, payment systems history, payment method adoption, mobile commerce research, mobile services adoption, and other relevant studies.

It is pertinent to mention that, although its importance in providing a better explanation to the adoption process is recognized, *subjective norms* are excluded from this study. As in the TAM and TAMMS, this paper aims at identifying innate characteristics of the service that affect user adoption of NFC mobile payments. It is suggested for future research to analyze the influence of *subjective norms* in the acceptance of NFC mobile payments.

To define the constructs that comprise the antecedents of NFC mobile wallet's usage, we have most notably used Dahlberg et al.'s (2007) mobile payments literature review and Dass and Pal's (2011) cumulative model for mobile financial services. Combining both studies resulted in a total review of 34 articles and a summary of over 32 constructs used on studies of consumer adoption of mobile payments. Despite the fact that some of the constructs were targeted towards mobile banking services some of the most common can be applied to this paper. The eight most mentioned constructs were identified, they are: *perceived ease of use*, *perceived usefulness*, *perceived financial cost*, *security*, *compatibility*, *perceived risk*, *convenience* and *trust*. In this paper *perceived ease of use* is included as a direct antecedent of *intention to use* NFC mobile wallets while *perceived usefulness* is replaced with *perceived value*, as proposed by the TAMMS. We also include *trust* as a direct driver of *intention to use* NFC mobile payments, as suggested by Kindberg, Sellen, and Geelhoed (2004) and Kaasinen (2005).

This paper devotes most of its development chapters to explain the elements influencing *intention to use* NFC mobile wallets, thus we concentrate on attitude formation by analyzing beliefs pertaining to *perceived value*, *perceived ease of use* and *trust* towards the technology and the constructs that support those beliefs.

To reinforce the relevancy of the previously mentioned constructs, studies on the *perceived value* of payment services and determinants of payment choice for traditional in-store payments such as cash, check, debit and credit cards were reviewed. According to the

reviewed literature, buyers consider the following payment method attributes as important: *ease of use* (Ondrus and Pigneur, 2005; Hitachi Consulting, 2010), *financial security*, *security and safety*, *speed* (Hitachi Consulting, 2010), *acceptance for payment*, *cost*, *convenience* (Foster et al. 2011), *record keeping* (Schuh and Stavins, 2010).

Throughout literature, *cost* is mostly regarded as an important element to consumers when deciding upon the adoption of payment methods (Plouffe, Hulland and Vandenbosch, 2001; Foster et al., 2011), however, one exception was found where cost posed as one of the least significant determinants in the intention to use mobile commerce (Wu and Wang, 2005). It is rather safe to conclude that cost influences adoption to some extent, but for the sake of simplicity cost is excluded from our model, it is assumed that the cost of using NFC mobile wallets is competitive when compared to other payment options.

4.3 The Model

The model presented in this paper attempts to define the process of consumer's intention to use NFC mobile wallets. Its hypotheses are derived from the information contained in the theory, studies and research covered in the previous chapters and sections. Figure 8 illustrates how the model is organized:

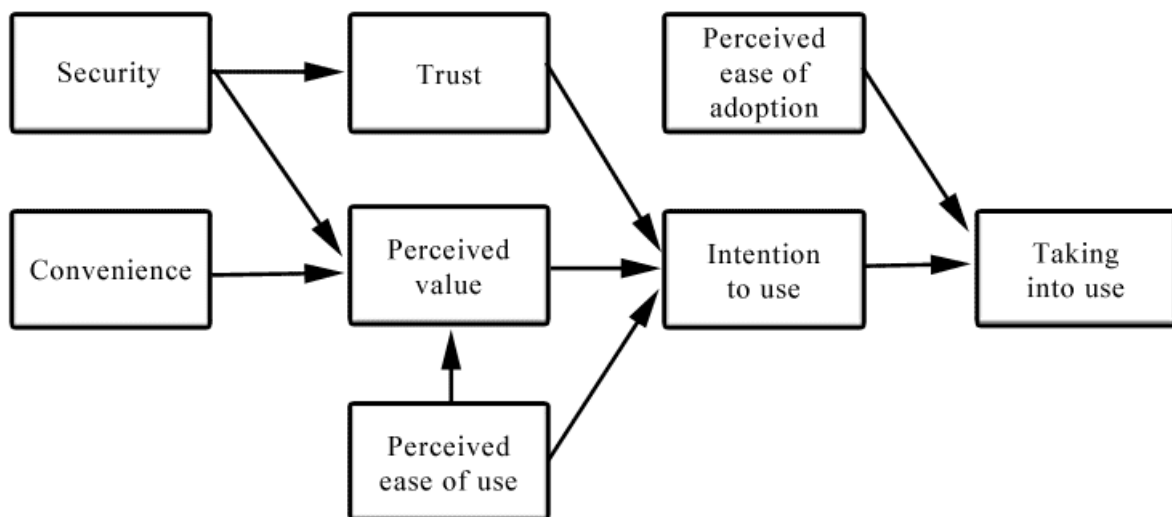

Figure 8: The TAM for NFC mobile wallets based on the TAM for Mobile Services by Kaasinen (2005).

Starting from the end-point, taking into use is a result of *perceived ease of adoption* and *intention to use*. *Intention to use* is comprised of *perceived value*, *perceived ease of use* and *trust*. *Security* influences *perceived value* and *trust*, while *convenience* influences *perceived value*.

The elements found in literature that are grouped in the *security* criteria include: *financial security*, *safety* and *perceived risk*.

Although literature lacks a clear definition of *convenience* in the context of payment methods, this paper covers three elements that are commonly mentioned together with convenience, they are: *speed*, *record keeping* and *acceptance for payments* (Smart Card Alliance, 2007; Foster et al., 2011).

In conclusion, for adoption and usage to occur, customers should perceive NFC mobile wallets as a better alternative with more valuable features than credit, debit card or other payment methods (Chen et al, 2011).

4.4 Antecedent of Perceived Value of NFC mobile wallet services: Beliefs

Attributes that correlate positively with attitude and behavior towards NFC mobile wallets are covered in this paper. An analysis of the beliefs associated with NFC mobile wallets is then conducted.

4.4.1 Beliefs about Perceived Ease of Use

In the TAM, Davis (1989) defines *perceived ease of use* as “*the degree to which a person believes that using a particular system would be free from effort*”. Venkatesh (2000) states that perceived ease of use is influenced by pre-usage (*anchors*) and actual usage (*adjustment*) determinants. Anchors are general beliefs about the service and service usage, such as: experiences of using similar services, information from other people and the user’s attitude towards technology (Kaasinen, 2005; Venkatesh, 2000), these factors are common in the adoption processes of most types of technology.

Research has shown that consumers who use new technology products tend to adopt electronic forms of payment quicker (Hayashi and Klee, 2003). In particular, direct deposit

use and making purchases on the internet contribute to a consumer's likelihood of using electronic payment methods. Surveys have also indicated there's a co-relation between education and payment choice; people with higher education have shown a negative appreciation of cash, while people with lower to medium levels of education displayed above average dissatisfaction with electronic payments (Jonker, 2005). Again, different levels of access to technology, supposing the higher educated tend to use technology more frequently, may explain this.

The determinants that influence *perceived ease of use* through actual usage are called *adjustment* factors. In order to assess whether or not NFC mobile wallets are perceived as easy to use it is necessary to determine some of the *adjustment factors* that are unique to the actual use of NFC mobile wallets in stores, as well as mobile services in general. Kaasinen (2005) gives us a few design principles that affect the *perceived ease of use* of mobile services: *clear overview of the service entity, fluent navigation on a small screen, smooth user interaction with the service, personally relevant services and information without expending effort on personalization set-up, easy access to situationally relevant information and services, facilitating momentary usage sessions on the move and design for device and network variety*. Not all of the proposed principles in Kaasinen's model were included; *context aware multimedia access* was removed since it is mainly targeted at mobile browser content providers. In the following an attempt to apply the *adjustment factors* findings and suggestion from the TAMMS to NFC mobile wallets is conducted.

Clear Overview of the Service Entity

Usability is of key importance to NFC wallet services. Every user should be able to easily access information about the service's characteristics and how to use it. This is especially important for first-time users. A common practice among software user-experience developers is the inclusion of a guided-tour and step-by-step explanation of how the service works and how to use the most important features. Since applications can identify first-time usage it can suggest such features to new users..

Users expect to the service to provide a complete overview of the most common questions and searched content, a feature that can be intuitively accessed. The main structure and design of NFC mobile wallets should be easy and simple. Design influences customers' quality perception; thus conducting user evaluation and tracking usage patterns is important

to help improve design. Research on e-commerce has shown that design influences quality and, consequently, trust on online services (Ha and Stoel, 2008).

Fluent navigation on a small screen

The TAMMS advises service providers to include the most personally and situationally relevant information on the first page/screen, in other words, the application should present information that applies to who is using the service, taking into account information such as when and where the service is being used.

Another instruction given in the TAMMS is for providers to select different types of navigation options; separate pages are better for navigation, except on the case of long pages with too much information, these should be scrollable. Details such as page title, back, forward, exit, home buttons and other navigation facilitators should be present whenever needed. In the case of NFC mobile wallets these characteristics should be carefully examined when offering content for customer support such as help guides and other extensive information.

Smooth user interaction with the service

Application developers should aim at minimal user-device interaction, in the case of NFC mobile wallets, actions such as adding or removing a card and, most importantly, making a purchase, requires the least amount of interaction. Throughout the case studies in the TAMMS the author observed that users find the experience of inputting text on mobile devices to be “*often tedious*” and suggests mobile service developers to provide users with alternative input methods such as spell checking and text prediction.

Most smartphones are equipped with the technology needed to enable context and location-aware services. In accordance with the suggestions in the TAMMS, NFC mobile wallet providers should take advantage of this technology and develop their applications with the ability to make suggestions based on context and location in order to minimize user’s input effort. For example: the service could suggest a credit card to be used for the purchase of a certain product based on previous usage. This could shorten the steps of the purchase process allowing for increased ease of use.

A clear advantage of the NFC technology lies in minimizing user interaction efforts by using its automatic application launching ability. In other words, even if the smartphone has other application open, such as a web browser, the user wouldn’t need to manually switch

applications to make a payment. Since the NFC chip is always active, it allows the mobile wallet application to be automatically loaded just by waving a mobile device over the NFC reader at the cashier or vending machine.

Personally relevant services and information without expending effort on personalization set-up

People have different spending habits and shopping patterns. Personalization refers to making the service compatible with user's characteristics. To the user, personalizing the service usually does not come into mind until he/she has begun using it. There are three types of service personalization: *manual personalization*, *profile-driven* and *learning personalization* (Norros, 2003 cited by Kaasinen, 2005). All three can be added to NFC payment services, although the effectiveness of each should be assessed through usage testing.

Manual personalization is based on user's manual input; it often requires manual, tedious form filling and is usually used to gather very particular information about user-service relation based preferences. Profile-driven personalization is defined through certain user characteristics such as demographic, marital status, and others. With the popularization of social networks and the possibility of logging in to new services using social network accounts, services could facilitate profile-driven personalization by using information already stored in social network profiles. Learning personalization makes use of usage logs, it analyzes usage patterns and adjusts the service according to past usage behavior.

Suggestion for service personalization based on popular usage patterns could be added to the service as ready-made packages. For example, a "budget-based" status could be added to NFC payment services to allow users to set a daily spending budget and be reminded of how much they have spent during the day and alerted once the limit is approaching.

Easy access to situationally relevant information and services

Situationally relevant information and services' ability to adapt to different user's needs, it refers to usage patterns, context and location. Users expect services to be not only compatible with the devices they are using but also that the information provided is tailored to specific situations. "In the user interviews regarding location-aware services, most users thought they would not mind having services or information pushed to them as long as the provided service or information was really what they needed in the situation" (Kaasinen,

2005), but the actual effect of these suggestions on satisfaction should be measured on usage settings.

The TAMMS proposes an approach where context and location awareness is paired with personalization to provide information that is unique to user's preferences. This could help in the development of additional service features based on data collected through payment interaction, such as suggesting, near-by restaurants that are offering daily deals around lunch time.

Facilitating momentary usage sessions on the move

Momentary usage sessions on the move occur in specific situations where the user can devote “*only part of their attention to using the service while their main attention...*” is “*on their main task of moving*” (Kaasinen, 2005).

Sometimes a payment is required in between actions. For example, when someone gets on a bus, paying for the ticket is a natural step between getting in and taking a seat. NFC mobile wallets may be used in “on the move” settings such as this, and the usage on these settings should be facilitated. The service could be set so that micro-payments or small value payments could be made without the need of tapping for confirmation or entering a PIN.

Design for device and network variety

In the case studies included in the TAMMS, the issue of *design for device and network variety* is analyzed for mobile content providers in a setting where users utilize a mobile web browser to access the service. NFC mobile wallets services are not performed or accessed through a mobile web browser, they use mobile applications instead. Thus, most of the suggestions in the TAM for Mobile Services for this determinant are not applicable to NFC mobile wallets but device compatibility can certainly be extended for NFC payment application usage. With the growing variety of smartphone models and operational systems, users expect service's characteristics and interaction to be consistent regardless of the device. Meeting the demand for compatibility can be an expensive and time demanding task, but it should allow for faster customer acquisition and growth.

This concludes our overview of the beliefs about *perceived ease of use* and serves as the base for our first hypothesis (H1a): Beliefs regarding *perceived ease of use* have a positive influence in the *perceived value* of NFC mobile wallet services.

4.4.2 Beliefs about Security

Security is one of the main factors that affect payment method adoption; it has been suggested that it favorably influences *perceived service value* and *trust* (Kaasinen, 2005; Chellappa and Pavlou, 2002). In an article titled “*Analysis of mobile payment security measures and different standards*”, a group of researchers have concluded that security is the biggest issue in the mobile payments field and that the absence of secure commercial exchanges and safe electronic financial transactions hinders trust in mobile payments (Kadhiwal, Usman and Zulfiqar, 2007).

Mobile payments’ security issues have been widely discussed in literature (Kadhiwal, Usman and Zulfiqar, 2007; Linck, Pousttchi and Wiedemann, 2006; Dahlberg, Mallat, and Öörni, 2003), however due to its novel nature, mentions of security of NFC mobile payments are rare. For this section of the paper a review of articles and research papers on mobile payment methods (including non-NFC) as well as e-commerce and traditional transactions was conducted. Aspects relevant to NFC mobile wallets were extracted from these publications. For example, prior to the advent of NFC mobile wallets and the popularity of smartphones, loss of information or unauthorized use was found to be one of the main security issues with mobile payments; customers are, among other things, concerned that, in case of loss or theft, other people could make purchases with their mobile device (Chari et al., 2001). It is assumed that this finding still holds true in the case of NFC mobile wallets.

When customers perceive a payment method as secure, the likelihood of usage and adoption is increased, even in situations where specific barriers or environmental settings bring concerns to customers, such as when the merchant’s reputation is questionable (Chellappa and Pavlou, 2002). Security measures will not influence users unless they are aware of them, thus it is critical to make consumers knowledgeable about security features in order to increase adoption (Karnouskos et al., 2004). Customers who refuse the adoption of mobile payment services point out perceived security as the most common reason for resistance (Linck, Pousttchi, and Wiedemann, 2006). For instance, raising customers awareness regarding the required close distance for two NFC devices to communicate with each other will favor perceived security (Falke et al., 2007). As previously mentioned in chapter 3.1 of this paper, it has been found that most people can only articulate a small number of information at the same time, this also holds true with information regarding potential risks, researchers have also observed that there’s a gap between technical risks and perceived risks;

with technical aspects being seldom mentioned while the fear of having the mobile device stolen or broken into are more salient (Kindberg et al., 2004).

Dahlberg, Mallat and Öörni (2003) and Linck, Pousttchi, and Wiedemann (2006) have developed studies focused on the determinants of perceived security towards mobile payments, the latter confirms and extends the findings of the former. Linck, Pousttchi, and Wiedemann (2006) divide security into *objective security* and *subjective security*. *Objective security* is comprised by the actual technic aspects of the device that make it more secure, while *subjective security* is the customers' awareness of these technological features and how they feel about it, we can refer to *subjective security* as *perceived security*, since they are basically the same.

By asking a sample of 3930 respondents the question: “*What would you require to feel secure about using mobile payments?*”, Linck, Pousttchi, and Wiedemann (2006) gathered the following results (in descending order based on the number of answers): *confidentiality, encryption, security, transparency and traceability, authentication and authorization, trust in the service provider, fraud protection, convenience and ease of use, secure infrastructure, liability issues, cancellation, third party certification, technical reliability, broad acceptance and diffusion, anonymity* and others.

A study by Pousttchi (2003) pointed confidentiality as one the most important criterion for customer acceptance and usage of mobile payments with over 90% of the respondents stating that it is “very important”.

All the studies mentioned in this section indicate a strong need for NFC mobile wallet providers to ensure customers that NFC mobile wallets are a secure payment option. Some of the features that can enforce that view are: the possibility of quickly blocking NFC payment features on lost devices, the built-in smartphone PIN lock, the ability of remotely tracking a lost device using GPS technology among others.

H1b: Beliefs regarding *security* have a positive influence in the *perceived value* and *trust* of NFC mobile wallet services.

4.4.3 Beliefs about Convenience

In this section we cover convenience in the context of NFC mobile wallets by presenting detailed information on three elements that together are assumed to be a part of convenience: *speed*, *record keeping* and *acceptance of payment*.

Speed

Speed is widely believed to be an element of convenience (Foster et al, 2011) and both are often presented together (Dewan and Chen, 2006), but the relation between the two is still inconclusive and more research on the subject is required. There's plenty of evidence in literature to believe speed is key to consumer's choice of payment methods. Most of the studies reviewed for this paper have listed speed of transaction, or the perceived speed, as one of the most important factors for payment method adoption. The only exception was found in the results of *The 2008 Survey of Consumer Payment Choice* (Foster et al. 2011).

Assessments of Characteristics of Payment Instruments
Percentage of consumers

	Most important	2nd most important	3rd most important	Least important
2009				
Instrument characteristic rating				
Acceptance for payment.....	22.2	23.8	26.0	27.6
Cost.....	25.5	27.2	21.4	25.5
Convenience.....	27.7	25.2	25.4	21.1
Security.....	54.9	25.7	13.6	5.2
2008^r				
Instrument characteristic rating				
Acceptance for payment.....	8.6	na	na	7.6
Acquisition and setup.....	0.4	na	na	41.3
Control over payment timing.....	10.9	na	na	18.1
Cost.....	10.1	na	na	5.5
Ease of use.....	28.7	na	na	4.7
Payment records.....	5.8	na	na	4.1
Payment speed.....	4.0	na	na	17.9
Security.....	31.6	na	na	0.8

NOTES: Superscript "r" denotes revised. Numbers in italics are not comparable across years due to changes in the survey. Numbers may not sum exactly due to rounding or missing values. The notation "na" indicates that the estimate is not available.

A comparison between the results of the *2008* and *2009 Survey of Consumer Payment Choice* (Foster et al. 2011).

Prior to the 2008 edition of *The Survey of Consumer Payment Choice* convenience was included as one of the factors respondents could select as important when choosing a payment method. In 2008, the study attempted to better define the concept of convenience by dividing it in five elements: *acquisition and set up*, *control over payment timing*, *ease of use*,

payment speed, and *record keeping*. The results showed that payment speed, when presented as a standalone importance factor to respondents' payment choice, performed poorly compared to other criteria. Since the relation between the five proposed elements and convenience was inconclusive the researchers decided to discard them, maintaining convenience in future surveys. *The 2009 Survey of Consumer Payment Choice* shows convenience as the 2nd most important determinant to payment selection.

The literature on payment method selection enforces the view that speed is indeed a strong determinant for payment choice. In a study titled *Payment Instruments as Perceived by Consumers – a Public Survey* (Jonker, 2005), perceived speed of the payment process has been the most-cited reason for choosing a particular payment method. Researchers have claimed that for NFC mobile payments to succeed as a payment method the time it takes to perform a transaction should be decreased to an acceptable level to both customers and merchants (Karnouskos et al., 2004). Speed has been pointed as an important factor in customer attraction (Ondrus and Pigneur, 2005).

NFC mobile payments have been compared to other payment methods and have been found to be faster and more convenient (Massoth and Bingel, 2009). Visa has stated that purchases with NFC mobile payments are up to 25% faster than cash transactions (Norton, 2006), this has also been observed in other studies (Ondrus and Pigneur, 2006). Providers of NFC mobile wallets should advertise their services as a fast payment alternative in order to make customers aware of the speed characteristics of the technology. It should be noted that not only is the speed of processing a transaction faster but the steps taken to perform the payment are also decreased, as compared to other options. For instance, the time it takes to count the money (in the case of cash), or to find a credit card in a wallet or purse. Consumers tend to carry more than one payment card or use a combination of different kinds of payment instruments (Au and Kauffman, 2008). The selection of the right credit card, debit card, or other card payments, takes time and is a repetitive task. Previous attempts to create a credit card that stores several credit cards information have been conducted (US Patent number 5276311) but never actively manufactured or marketed. Selecting a credit or debit card using an NFC mobile wallet application is easy and simple and the process can even be automated. For instance, if a customer always uses the same debit card for grocery shopping the smartphone will seamlessly select it every time the user is making a purchase at the grocery store.

As mentioned in the *perceived ease of use* section, a debit or credit card could be selected as the default for micro-payments. For instance, just waving the NFC mobile device next to a reader, without the need for further interaction, could allow transactions under a certain pre-defined value. In sum, NFC mobile payments should result in faster flow of customers through cashier stations. (Chen et al., 2011)

H1c: Beliefs regarding *speed* have a positive influence in the *perceived value* of NFC mobile wallets.

Record Keeping

Although record keeping has been suggested to be one determinant that relates positively to payment method choice (Hitachi Consulting, 2010; Foster et al., 2011), the literature on payment methods, mobile or traditional, lacks information on the subject and its influence on consumer behavior. Payment records can either be paper or electronic based. As mentioned earlier, NFC mobile wallets make paper receipts obsolete; transactions are stored on the consumer's mobile phone.

NFC mobile wallets offer the tools necessary to provide an unprecedented level of record keeping for consumers, the service could store detailed purchase information such as time, location, item, and transaction value.

Service providers can offer additional services to not only allow customers to store and access purchase receipts on their NFC enabled devices, but also store the user's payment history on the cloud to be accessed from any device connected to the web. Due to the low cost of server storage, NFC mobile wallet services should be able to virtually provide an unlimited history log of transactions. Payment data gathered can be presented in several ways to provide users with detailed reports on spending patterns.

This type of control over spending may incentivize customers to start utilizing NFC mobile wallets. Focus groups with potential early adopters of mobile payments have shown that consumers want to control their consumption and debt (Dahlberg and Mallat, 2002). Mallat (2006) interviewed consumers on mobile payment adoption and has found that the lack of transaction documentation and record is considered risky.

H1d: Beliefs regarding *record keeping* have a positive influence in the *perceived value* of NFC mobile wallet services.

Acceptance of Payment

Consumers will benefit from a large network of retailers who accept NFC mobile payments, and vice-versa. Network externalities play an important role in understanding the peculiar aspects of payment acceptance. The Survey of Consumer Payment Choice (Foster et al., 2011) has evaluated *acceptance of payment* separately from convenience in 2009, but included it as an element of convenience in 2008; when asked its relevancy to payment choice as an element of convenience, *acceptance of payment* has been poorly rated, while it was regarded as relevant when displayed separately.

The market for NFC mobile wallets is two-sided; to function properly it depends as much on retailer's adoption of NFC technology as consumer's. Acceptance of payment refers to the availability of the payment option at retailer's location. For customers to perceive NFC mobile wallets as valuable they need to be able to use the service in as many POS as possible. Limited acceptance will result in customers being frustrated with the service (Au and Kauffman, 2008). It is important that NFC mobile payment services inform potential customers of the service availability especially at a local level.

H1e: Beliefs regarding *acceptance of payment* have a positive influence in the *perceived value* of NFC mobile wallet services.

4.5 Antecedents of Intention to Use NFC mobile wallets

The literature on consumer behavior is heavily grounded on the concept that, when the right conditions are met, behavioral intention should be enough to predict behavior (TRA, TPB, TAM). Thus, intention to use NFC mobile wallets is the main antecedent of engaging in NFC mobile wallet usage. Kaasinen's TAM for Mobile Services presents four antecedents of intention to use mobile services in general, they are: *perceived value of the service*, *perceived ease of use*, *trust* and *perceived ease of adoption*. In this section, each of these items is reviewed and an assessment of how they apply to NFC mobile wallet services is made.

4.5.1 Perceived Value of the Service

It is common for providers to develop and add a wide range of features to their services in order to increase competitiveness. However, customers are usually only interested in a pre-

defined set of features; the few key elements that, in their opinion, make the service valuable. The TAMMS states that value can be based on utility, communication or fun (Kaasinen, 2005). Mobile payments in general, are classified as goal-directed services (Nysveen, Pedersen and Thorbjørnsen, 2005), which means that its value is based on utility. Thus the main value proposition would most likely focus on the ability of seamlessly making payments, with a satisfying level of convenience, when compared to other alternatives, and the least amount of barriers in the process. As covered in chapter 3.1, prior to deciding upon selecting or adopting a service, it is natural that an evaluation of the features and the advantages that result from them is conducted. *Perceived value* is comprised of the advantages consumers find to be more important in a service (Kaasinen, 2005). Consumer's decision to adopt or reject a service is determined by its perceived value in comparison to existing alternatives (Anckar, 2002; as cited by Anckar and D'Incau, 2002). Thus, defining the service characteristics that are truly appreciated by consumers is critical to create a successful value proposition capable of increasing behavioral intention towards adoption (Dahlberg and Mallat, 2002).

Early mobile commerce research, as well as mobile commerce based ventures, mostly focused on mobile devices as a new enabler of - and channel to engage in - e-commerce transactions and web based commercial and banking services. It's now visible that, at the time, researchers were more interested in knowing the advantages of making online transactions on a mobile device rather than on a computer and didn't consider mobile phones as a possible substitute for cash or credit cards (Anckar and D'Incau, 2002). That's not to say that there weren't plenty of attempts at using mobile phones in retail settings (Dahlberg, Mallat and Öörni, 2003). However, the main suggested value proposition rested on mobility, the ability to make electronic payments without time or spatial constraints, with the alternative option being using a computer.

In the case of NFC mobile wallets, the alternative options are cash, credit or debit cards, checks and other payment options. For adoption to occur, the perceived value of NFC mobile wallets has to be greater than the alternatives. Although more research is needed, there's evidence to support that NFC mobile payments possess solid advantages on all of our suggested elements of perceived value: *perceived ease of use*, *security*, and *convenience*, when compared to other POS payment alternatives.

H2a: Attitude towards intention to use NFC mobile wallets is influenced by *perceived value of the service*.

4.5.2 Perceived Ease of Use

The characteristics of *perceived ease of use* for NFC mobile wallets was extensively covered in section 4.4.1, when its influence on *perceived value* was analyzed. *Perceived ease of use* has been found to have greater influence when users are unfamiliar with a certain technology, and it is posed to lose some of its importance once users gain more experience (Wu and Wang, 2005). It is safe to say that, in the present, NFC mobile wallets are a new technology to most mobile device users and that *perceived ease of use* should be regarded as an important element that proceeds of *intention to use*. NFC mobile wallets are regarded as very intuitive, more simple and quick to use than classical mobile payment services (Falke et al., 2007).

H2b: Attitude towards intention to use NFC mobile wallets is influenced by *perceived ease of use*.

4.5.3 Trust

Trust has been studied through social and evolutionary perspectives (Berg et al., 1995). This section examines and utilizes definitions pertaining to trust towards organizations and services, as opposed to trust in individuals. Widely mentioned and researched in the context of e-commerce transactions (Shneiderman, 2000; Resnick et al, 2000), trust is posed to influence mobile transactions as well. The concepts found in literature are very homogenous; trust is constantly portrayed as the result of confidence in something. Garbarino and Johnson (1999) define trust as the confidence in the quality and reliability of the services offered. Similarly, Gefen (2000) defines trust as “the confidence a person has in his or her favorable expectations of what other people will do, based, in many cases, on previous interactions”. In the TAMMS, Kaasinen (2005) presents a comprehensive review of trust in the context of mobile and e-commerce services and concludes by borrowing the definition of trust from Fogg and Tseng (1999) whereas trust is an “*indicator of a positive belief about the perceived reliability of, dependability of, and confidence in a person, object or process*”. The same definition should be suitable for the purpose of this paper.

Early research on mobile payment adoption has demonstrated the importance of trust as an antecedent of behavioral intention to consumer's adoption of such services (Dahlberg, Mallat and Öörni, 2003). In the model suggested in this paper, *perceived security* is postulated to precede *trust*. That is, maintaining all else equal, if a consumer perceives a service as secure, he/she will most likely trust the service. Most financial transactions are founded in trust (Eze et al, 2008). In the case of NFC mobile wallets it is necessary for the customer to trust not only the technology, but also the service provider (Karnouskos et al., 2004). Trust is a critical enabler for mobile payments, essential to its success, making security a basic requirement; neither an additional feature nor a competitive advantage (Karnouskos et al., 2004; Ondrus and Pigneur, 2006). Security issues regarding NFC mobile payments were covered in detail on section 4.1.2 of this paper.

Lack of trust in vendors poses as a significant barrier to mobile commerce transactions (Siau et al., 2004). Due to the large amount of personal data payment services are able to gather from its customers; privacy and anonymity become essential elements for the success of mobile payment services (Kaasinen, 2005; Karnouskos et al, 2004; Karnouskos, 2004). Credit card and bank account numbers are confidential and the consumer has to place a considerable amount of trust in the NFC mobile wallet service before supplying this kind of financial information. It has been noted that services associated with already trusted entities should be able to overcome this adoption barrier more easily (Karnouskos et al., 2004), and that, in this context, financial institutions and mobile carriers, of which the consumer is already a member of, have a suitable level of trust to enter the NFC mobile wallet's market (Mallat, 2006; Smart Card Alliance, 2007). However, banks and mobile carriers cannot work by themselves; partnerships are needed in order to create a favorable environment for NFC mobile payments (Au and Kauffman, 2008).

Smart Card Alliance's report on proximity payments (2007) suggests that NFC mobile payment services' providers should offer a zero liability policy and invest in consumer education, similarly to the campaigns developed by financial institutions to teach consumers how to prevent ATM safety and fraud issues. Kaasinen (2005) suggests that users should feel in control and be aware of the amount of personal data that is being used by the service and that the privacy of the user should be protected even when the user doesn't explicitly require it.

H2c: Attitude towards intention to use NFC mobile wallets is influenced by *trust*.

4.6 Perceived Ease of Adoption

Perceived ease of adoption has been suggested as an important antecedent of adoption in the TAMMS. This construct should be, together with *intention to use*, an indicator of taking the service into actual usage. Differently from the original TAM (Davis, 1986), which was developed through the observation of settings where applications are pre-installed and ready to use, mobile services often require users to go through installation, configuration and personalization stages. These stages of taking mobile services into actual use may act as an obstacle to adoption for consumers (Kaasinen, 2005).

Prior to installation, customers have to find the NFC mobile wallet service application either through a website or application market place. Service providers should aim at making their applications easy to find (Kaasinen, 2005). Once the application is found, customers will proceed to download and install it. The process of installing an NFC mobile wallet service application, and getting it ready to perform a transaction, should be as close to an “out of the box” solution as possible; quick and completed with as little interaction as possible (Smart Card Alliance, 2007).

Since NFC mobile wallets use the existing payment infrastructure, the customer doesn't need to go to a financial institution or visit a website to apply for an NFC mobile payment license or card. Customers will load their NFC mobile wallets with their current bank information and credit or debit card numbers. In other words, there's no need to contact third-party issuers, setting up an NFC mobile wallet and is completely self-service.

Most people tend to avoid change, so it is worthy to mention that customers are also required to learn how to use their NFC mobile wallets at the POS and some may see that as a barrier regarding since the process of payment will be considered new. Differently from credit cards, where swiping has become a natural behavior for most people, the act of waving a phone over a reader should be learned during the adoption process (Chen et al., 2011). However researchers tested NFC devices in controlled settings with groups of people who were unfamiliar with the technology and, by observing their behavior they have concluded that the act of waving the phone shouldn't pose as a real barrier; NFC technology is considered to be of very easy adoption (Falke et al., 2007).

H2d: Attitude towards intention to use NFC mobile payments is influenced by *perceived ease of adoption*.

5. Methodology

This chapter covers the proposed methodology for testing and validating the model. First, the ideal population sample for this research is described, which should be comprised of respondents who possess the necessary requirements, or have realistic means, to adopt NFC mobile wallets. Second, based on the elements discussed on chapter 4, the design of a survey questionnaire is then presented, taking into account research theories and survey methods, to define measures that can efficiently capture relevant responses to the concepts the model aims to verify. Lastly, a suggestion for data analysis is presented using techniques that could present the various relations between moderating variables while lowering the chance of cognitive bias in the research.

5.1 Sample

Since the study targets potential adopters of NFC mobile wallet services, the ideal sample should consist of subjects that meet basic requirements for adoption, such as: owning an NFC enabled mobile device, using traditional financial services (bank account, credit or debit cards) and being in a geographical location where NFC mobile wallet services and accepting merchants are available. People who meet these criteria represent the intended sample population quite well.

Due to time restraints, and taking into account the low availability of NFC enabled mobile devices and wallet services on the market during the time of this writing (Hirson, 2012), finding a considerable sample of subjects which fulfills the pre-requisites for adoption and, consequently, allows for the evaluation of the proposed model was not possible. However, the number of NFC enabled mobile devices is expected to grow considerably in the next few years together with the availability of mobile wallet services. Based on the current market forecasts we propose guidelines to empirically verify the hypothesis contained in this paper once a significant sample of subjects can be gathered.

Demographic variables such as age, gender, income, level of education and familiarity with technology should be included so that co-relations pertaining to intention patterns could be studied and conclusions derived with better precision. It has been noted that consumers engage in the usage of multiple payment methods to maximize utility and that payment

method selection correlates to income, age and other demographic characteristics (Au and Kauffman, 2008). Although the sample characteristics described above would be ideal to conduct the research, owners of smartphones should easily be able to understand the concept of the service and answer questions pertaining to the elements of the model. Thus, the minimum suggested requirement to take part on the survey would be the ownership of a smartphone device.

Prior to running the survey through a large sample population, it is advisable to conduct a pilot study with fewer subjects than the amount intended for the final survey. After this initial study is conducted, answers, suggestions and comments that are relevant to the study should be compared and analyzed in order to improve the survey questions. The final sample size should be sufficiently large, accounting for different types of users so that it can realistically represent the potential consumer population.

5.2 Survey questions and measures

As mentioned in section 5.1, the final survey should be a result of gradual improvement of the proposed questions after it has been conducted through a pilot study. The questions and scales presented in this paper should be considered as a starting point, its use to measure the key constructs of our model are not final and must be verified before the survey is presented to a larger sample of subjects. The pilot study should be conducted in a controlled environment, where subjects are given the opportunity to communicate their thoughts regarding the survey directly to the researchers. The application could use paper or computer based surveys with space for questions and comments on the various points presented.

Underlying factors related to the attributes of the service could be identified by methods of exploratory factor analysis (EFA) applied to the pilot study results. To verify correlations across these factors, oblique rotation methods such as oblimin can be used; remaining items can then be validated by the use of Cronbach's alpha.

The application of the final survey wouldn't require substantial amount of supervision from the part of the researchers and could be conducted through an online survey.

The first questions of the survey should aim at identifying the subject. Besides usual demographic information such as age, gender, income and formal education level, questions

pertaining to the usage of technology (most importantly smartphones) should be added at the start. In case the user is not familiar with smartphones usage he/she should be discarded from the study.

The survey's questions presented here were derived from the elements covered in chapter 4 and constructed in a manner that aimed at testing the nine hypotheses presented in the paper. Due to the fact of it being a novel technology and service, subjects should be exposed to a short introduction of NFC mobile wallets; one that is neutral in regards to the advantages of the technology, presenting its features without praising them.

To evaluate the feeling of subjects towards the key constructs of the study, up to 6 questions related to each of the 6 constructs were developed, two questions regarding intention were also included, totaling 27 questions. The suggested measurement is based on a likert-scale of five points that ranges from *strongly agree* to *strongly disagree*.

The relation of the survey items and the key constructs of the model can be observed in the following table:

Item number	Key construct
1, 2, 3, 4 5,6	Perceived ease of use
7, 8, 9, 10, 11	Beliefs about security
12, 13, 14	Beliefs about convenience
15, 16, 17, 18, 19	Perceived value of the service
20, 21, 22	Trust
23, 24, 25	Ease of adoption
26, 27	Intention to use

The proposed survey structure, including scales and questions, is presented in section 5.2.1.

5.2.1 Suggested survey structure

NFC Mobile Wallets

Age:	Education level:
Gender:	Own a smartphone: () Yes () No

Please read the paragraph below and answer the questions that follow.

NFC mobile wallets turn smartphones into wallets; digitally holding credit and debit cards, loyalty cards, discount coupons and other financial information. It is used at the point-of-sale; places like restaurants and grocery stores. NFC mobile wallet users select the credit card they want to use on the smartphone and wave the device over a reader; with a maximum distance of 4 cm. The user inputs the PIN code in the smartphone screen and the purchase process is finished, with the receipt being stored digitally in the smartphone.

In the context of NFC mobile wallets usage, please respond to how you feel regarding the statements presented below by using a scale of 1 to 5. Scale description: (1) *Strongly Disagree*, (2) *Disagree*, (3) *Neutral*, (4) *Agree*, and (5) *Strongly Agree*.

1. Step-by-step information on how the service works should be offered for first time users	1	2	3	4	5
2. I value easy access to frequently asked questions about the service	1	2	3	4	5
3. I consider the design of the application to be important	1	2	3	4	5
4. Being able to personalize and customize the service is fundamental	1	2	3	4	5
5. The level of interaction with the service needed for purchases should be minimal	1	2	3	4	5
6. Location-aware card suggestion	1	2	3	4	5

7. I am concerned about the security of the service	1	2	3	4	5
8. I believe the low range (4 cm) distance needed for transactions to be safe	1	2	3	4	5
9. I am concerned about loss or theft of the smartphone	1	2	3	4	5
10. Smartphone features such as pin lock and GPS location improve security	1	2	3	4	5
11. I believe the service has a potential to be safer than traditional payment options such as credit cards and cash	1	2	3	4	5

12. The speed of the transaction should be the same or fastest than current payment options	1	2	3	4	5
13. I consider keeping track of receipts and transaction records a tedious task	1	2	3	4	5
14. I would only use the service if it is widely accepted in stores	1	2	3	4	5

I consider the following to be key value propositions of the service (questions 15 to 19):

15. Making payments easily	1	2	3	4	5
16. The speed of transactions	1	2	3	4	5
17. Keeping a record of transactions and receipts	1	2	3	4	5
18. The number of merchants where the payment is accepted	1	2	3	4	5
19. Safety on transactions and data confidentiality	1	2	3	4	5

20. The service should offer zero liability in the case of theft or loss	1	2	3	4	5
21. I would only use the service if it is backed up by a financial institution I am already familiar with	1	2	3	4	5
22. I want to be in control of my information, being able to know exactly what type of personal information the service keeps.	1	2	3	4	5

23. The service should be easy to install on the smartphone	1	2	3	4	5
24. I prefer to configure and input my financial information by myself instead of being helped by customer support	1	2	3	4	5
25. I believe the act of waving the phone over a reader to be as simple as swiping a credit card	1	2	3	4	5

26. I intend to use my smartphone to store my credit and debit cards	1	2	3	4	5
27. It is very likely that I will use my smartphone to pay at the point-of-sale	1	2	3	4	5

5.3 Data analysis

Once the surveys are conducted and the resulting data is gathered, it is necessary to analyze it in a proper fashion so that the hypotheses can be validated or discarded. The resulting data can be analyzed in several ways; it is up to the researcher who conducts the survey to decide the techniques that may provide precise conclusions. Since, for the time being, there is no way to determine how the final survey will turn out, the suggestions here are vague, as it would require having the actual data to make concrete decisions on how to analyze it. But in the meantime a few humble suggestions can be made.

The survey was divided in 7 sections; items should be analyzed individually and in groups in order to determine how the beliefs and constructs of the model relate to each other. Since the model suggests that elements such as *security*, *convenience* and *ease of use* have a direct effect in the determinants of intention (*perceived value and trust*), these three elements should be analyzed first. Different techniques such as ANOVA, multiple linear regression and others may be applied and can be used to verify the results against the hypotheses. As a first step, measurements such as mode, mean and standard deviation should be conducted. Factor analysis can also be used as an attempt to explain variance in the results. The relationship between dependent and independent variables could be tested through multiple linear regression. Second, the influence of *perceived value*, *trust* and *ease of use* on *intention to use* could be analyzed in the same manner, and lastly the influence of *intention to use* and *ease of adoption* should be in combination with the other constructs. The relation between demographics and its influence in the intention to use NFC mobile wallets can be analyzed through ANOVA.

As of now there's a clear limitation on how the data should be analyzed since the model is still in a very early study phase. More techniques of validation and the use of data analysis software can help in bringing better results and forming better conclusions.

6. Managerial Implications

In case the hypothesis presented in the paper turn out to be valid they should serve as guidelines for NFC mobile wallet providers when marketing and developing their services. A few of the managerial implications are discussed for each of the suggested hypothesis.

Regarding *perceived ease of use*, which according to hypothesis H1a and H2b are posited to influence both the *perceived value* of the service and the *intention to use*, developers should aim at making the service as frictionless as possible, in the sense that learning how to use and taking into use would be effortless. Marketing professionals are advised to present the services to customers as a payment method that is easy to use, showing examples and using customer testimonials on how simple it is to use it.

Perceived security (H1b) and *trust* (H2c) are two constructs that are related to each other. *Perceived security* influences both *trust* and *perceived value*, while *trust* influences intention to use. It has been noted that *perceived security* is an essential part of payment method adoption and that *trust* is required for financial transactions (Dahlberg, Mallat and Öörni, 2003), if this turns out to be true for NFC mobile wallets, developers and managers should concentrate into making the services as secure as possible and quickly respond to rumors regarding the lack of confidentiality, data theft and other security issues. *Trust*, as seen in section 4.5.3 of this paper, can be improved by associating the service with already trusted parties such as banking institutions and mobile carriers (Smart Card Alliance, 2007). Marketing campaigns should focus on security features that are similar to the ones offered by traditional payments, such as zero liability in cases of theft, and compare NFC mobile payment services with traditional wallets in situations where NFC wallets are safer, to convey a message of increased safety when using NFC mobile payments. A few of the comparison points could cover: *the loss of a smartphone vs. a traditional wallet*, with the smartphone supporting GPS location, *access to financial information*, with the smartphone requiring a PIN to be unlocked, among other features.

The hypotheses related to convenience: *speed* (H1c), *record keeping* (H1d) and *acceptance of payment* (H1e), are posited to influence the *perceived value* of the service. While *speed* and *record keeping* are constructs that NFC mobile payments can apparently satisfy better than conventional payment methods, *acceptance of payment* remains as a tricky point in the convenience mix. That's because it is necessary for merchants to adopt NFC enabled

terminals at their stores first. Merchants have to perceive NFC mobile payments as a feasible addition to their current assortment of accepted payment methods, in this case managers and marketers have to: a) find options to lower the costs for merchant adoption, maybe subsidizing NFC enabled terminals and b) convince merchants that NFC mobile wallets will become a standard payment method used by a large number of consumers. The advantages regarding *speed* and *record keeping* are assumed to be easy to market, since with all of the payment information stored on the smartphone the process of selecting credit or other types of card should be easy, maybe even automatic in the case of services that suggest cards depending on location or type of purchase. *Record keeping* is almost a given, due to the digital nature of the transactions and the fact that receipts are only bits of text, which are easy to store. The emphasis marketers should place on these three convenience elements should depend on the level of favorability respondents place on each of them.

Perceived value of the service is hypothesized to directly influence *intention to use* (H2a). All of the elements covered in this section so far are posited to have an influence on the *perceived value* of NFC mobile wallets. Although *perceived value* relates more to the goals the service aims to achieve (making payments), the previously mentioned constructs are supposed to support the inherent goals of the service. This construct is basically determined by the importance consumers place on each of the beliefs associated with the service. The features to be included in the NFC mobile wallet service should be carefully studied in order to avoid goal-dilution (Fishbach, Zhang and Kruglanski, 2007). In the end marketers should place most of their efforts in creating a message that focuses on presenting the *perceived value of the service* to potential customers.

Installing applications on smartphones is very simple; a process that can be completed with only a few clicks, and this shouldn't be different in the case NFC mobile wallets. If the positive influence of *perceived ease of adoption* on intention is validated, developers and managers should aim at testing the service to remove unnecessary interaction for adoption and making the whole process as free from effort as possible. Marketing managers should add, after presenting the advantages of the service, how easy and fast it is to install and configure it. Traditional approaches for this type of action could involve presenting the installation process in a three steps fashion and stating that it takes only a short amount of time to get it ready to use. Product development managers should include the installation process in the test phases and analyze how it can be improved. The TAMMS suggests that users expect to receive clear descriptions of how the service may facilitate everyday life and

that providers should aim at making their services fit into existing usage cultures (Kaasinen, 2005).

It's worthy to note that there are limitations in how the constructs are obtained, literature was extensively reviewed to define the attributes included in this paper but an alternative approach to define different sets of attributes, which may be important to users of NFC mobile payments services, or even validate the current set, is to use human-centered design techniques to analyze the steps involved in regular purchase transactions and create scenarios where a smartphone based service can improve that experience.

6.1 Limitations

Although the suggested model in this paper still needs to be empirically verified, a few limitations have to be addressed in the case of future research. First, the inclusion of *subjective norms* can be an interesting addition to the model and may help to explain the variance in results. On its report on *Proximity Mobile Payments*, the Smart Card Alliance (2007) states that there's a 'coolness' factor attached to the use of NFC mobile payments and that young consumers may be influenced by it. In the study of mobile payments the influence of *subjective norms* is completely uninvestigated (Massoth and Bingel, 2009).

Another element that could pose as an important addition to the consumer adoption process is *cost*, it has appeared in several payment methods and is suggested that its influence is significant.

The main limitation to this study is in the fact that NFC mobile wallet services may be years away from mass adoption: "User acceptance is crucial to the success of new technologies but it is difficult to predict. Disruptive technologies are especially hard to predict because these technologies may take decades or longer to undergo the transition into everyday objects" (Norman, 1998, as cited in Kaasinen, 2005).

References

Ajzen, I., and Fishbein, M. (1980). *Understanding Attitudes and Predicting Social Behavior*. Englewood Cliffs: Prentice-Hall, Inc.

Ajzen, Icek (1985). From intentions to actions: A theory of planned behavior. In J. Kuhl & J. Beckman (Eds.), *Action-control: From cognition to behavior*. Heidelberg: Springer. p. 11-39.

Ajzen, Icek. (1991). The Theory of Planned Behavior. *Organizational Behavior and Human Decision Processes*, 179-211.

Amoroso, D. L. and Magnier-Watanabe, R. (2011). Building a Research Model for Mobile Wallet Consumer Adoption - The Case of Mobile Suica in Japan. *Journal of Theoretical and Applied Electronic Commerce Research*. ISSN 0718–1876 Electronic Version, vol 7, issue 1, p. 94-110.

Anckar, B. (2002). Rationales for Consumer Adoption or Rejection of E-Commerce: Exploring the Impact of Product Characteristics, *Proceedings of the SSGRR 2002s Conference*, L'Aquila, Italy.

Anckar, B. and D'Incau, D. (2002). Value Creation in Mobile Commerce: Findings from a Consumer Survey, *Journal of Information Technology Theory and Application (JITTA)*: Vol. 4: Iss. 1, Article 8.

Armitage, C. J. and Conner, M. (2001). Efficacy of the Theory of Planned Behaviour: A meta-analytic review, Department of Psychology, University of Sheffield, UK Mark Conner, School of Psychology, University of Leeds, UK 40, p. 471–499.

Atkinson, J. W. (1964). *An introduction to motivation*. Princeton, NJ: Van Nostrand. (Cited by Ajzen, 1991)

Au, Y.A., and Kauffman, R.J. (2008). The Economics of Mobile Payments: Understanding Stakeholder Issues for An Emerging Financial Technology Application. *Electronic Commerce Research and Applications* 7(2) 141-164.

-
- Bentler, P.M. and Speckart, G. (1979). *Models of attitude-behavior relations*. Psychological Review, vol. 86, No. 5, 462-479.
- Berg, J., Dickhaut, J. and McCabe, K. (1995). Trust, Reciprocity, and Social History, *Games and Economic Behavior*, Volume 10, Issue 1, July 1995, Pages 122-142.
- Bertrand, M. and Bouchard, S. (2008). Applying the technology acceptance model to VR with people who are favourable to its use. *Journal of Cyber Therapy & Rehabilitation*, 1(2), p. 200-207.
- Bettman, J. R., Capon, N. and Lutz R. J. (1975). Multiattribute Measurement Models and Multiattribute Attitude Theory: A Test of Construct Validity, *Journal of Consumer Research*, p. 1-15.
- Bettman, J. R., Johnson, E. J., and Payne, J. W. (1992) "Consumer Decision Making," in *Handbook of Consumer Behavior*, Thomas S. Robertson & Harold H. Kassirjian (eds.) New Jersey: Prentice Hall.
- Bravo, J., Hervás, R., Chavira, G., Nava, S. and Villarreal, V. (2008). From Implicit to Touching Interaction: RFID and NFC Approaches. *Human System Interaction Conference, HSI'08*. Krakow, Poland. p. 1-6. <<http://mami.uclm.es/nuevomami/publicaciones/HSI-jbravo%20%20%20-G.pdf>> (03 April 2012)
- Burrows, P. (2010). Apple vs. Google: How the battle between Silicon Valley's superstars will shape the future of mobile computing. *Bloomberg, BusinessWeek*. 01.14.2010. <http://www.businessweek.com/magazine/content/10_04/b4164028483414.htm> (25 February 2012)
- Caldwell, T. (2012) Locking down the e-wallet, *Computer Fraud & Security*, Volume 2012, Issue 4, April 2012, Pages 5-8.
- Chari, S., Kermani, P., Smith, S., and Tassiulasa, L. (2001). Security Issues in M-Commerce: A Usage-Based Taxonomy. In *E-Commerce Agents, Marketplace Solutions, Security Issues, and Supply and Demand*, Jiming Liu and Yiming Ye (Eds.). Springer-Verlag, London, UK, p. 264-282.
- Chellappa, R. K. and Pavlou, P. A. (2002). Perceived information security, financial liability and consumer trust in electronic commerce transactions, *Logistics Information Management*, Vol. 15 Iss: 5/6, pp.358 - 368
- Chen, P. S. and Hitt., L. M. (2002). Measuring Switching Costs and the Determinants of Customer Retention in Internet-Enabled Businesses: A Study of the Online Brokerage Industry. *Info. Sys. Research* 13, 3 (September 2002), p. 255-274.
- Chen, J., Hines, K., Leung, W. and Ovacic, N., (2011) NFC Mobile Payments. Center for Entrepreneurship & Technology, University of California, Berkley. p. 2-17. <<http://www.jessechen.net/portfolio/ieor171-finalpaper.pdf>> (04 March 2012).
- Currim, I. S. and Sarin, R. K. (1984). A Comparative Evaluation of Multiattribute Consumer Preference Models, *Management Science*, Volume 30, n 5, p. 543-561.

Dahlberg, T. and Mallat, N. (2002). Mobile Payment Service Development - Managerial Implications of Consumer Value Perceptions. ECIS 2002 Proceedings. Paper 139.

Dahlberg, T., Mallat, N. and Öörni, A. (2003): Trust enhanced technology acceptance model: Consumer acceptance of mobile payment solutions, The Stockholm Mobility Roundtable, Stockholm, Sweden.

Dahlberg, T., Mallat, N., Ondrus, J. and Zmijewska, A. (2007). Past, present and future of mobile payments research: a literature review. *Electronic Commerce Research and Applications*, 7, 2008, p. 1–14.

Danes, J. E. and Cattin, P. (1980). Multiattribute Choice Models: A Critical Review, in *Advances in Consumer Research*, vol. 8, Kent B. Monroe ed., Association for Consumer Research, Ann Arbor, MI. p. 323-328.

Dass, R. and S. Pal (2011). Exploring the factors affecting the adoption of mobile financial services among the rural under-banked. *European Conference of Information Systems - 2011*. Helsinki, Finland. p. 2-12.

Davies, G. and Davies, R. (2002). A comparative chronology of money. Based on the book: *A History of Money from Ancient Times to the Present Day*. ed. Cardiff: University of Wales Press, 1996. <<http://projects.exeter.ac.uk/RDavies/arian/amser/chrono1.html>> (23 January 2012)

Davis, F. D. (1986). A Technology Acceptance Model for Empirically Testing New End-User Information Systems: Theory and Results, doctoral dissertation, MIT Sloan School of Management, Cambridge, MA, 1986.

Davis, F. D. (1989). Perceived Usefulness, Perceived Ease of Use, and User Acceptance of Information Technology. *MIS Quarterly* , Vol. 13, No. 3. p. 319-340.

Day, G. (1972). Evaluating Models of Attitude Structure, *Journal of Marketing Research*, 9, August, p. 279-286.

Delloite (2012) The future of mobile payments in Canada. Financial Services market update: Industry transactions. p. 1-3. <http://www.deloitte.com/assets/Dcom-Canada/Local%20Assets/Documents/FA/ca_en_fa_Q4_financial_services_032212.pdf> (05 March 2012)

Dewan, S. G. and Chen, L. D. (2006). Mobile Payment Adoption in the US: A Cross-Industry, Cross-Platform Solution. *Journal of Information Privacy and Security*. 2006, 1(2). p. 4-28.

Dodson, B. and Lam, M. S., (2011) P2P Micro-Interactions with NFC-Enabled Mobile Phones. p. 16-19 <<http://mobisocial.stanford.edu/papers/microinteractions.pdf>> (03 March 2012)

Donovan, J. (2012). Do We Even Need NFC For Mobile Payments? PayPal, Google Weigh In (Video). *TechCrunch*. 06.04.2012 <<http://techcrunch.com/2012/04/06/do-we-even-need-nfc-for-mobile-payments-paypal-google-weigh-in-video/>> (10 April 2012)

Eze, U. C., Gan, G. G. G., Ademu, J. and Tella, S. A. (2008). Modelling User Trust and Mobile Payment Adoption: A Conceptual Framework. *Communications of the IBIMA*, Volume 3, Issue, 29. p. 224-231.

Falke et al., O., Rukzio, E., Dietz, U., Holleis, P., and Schmidt, A. (2007). *Mobile Services for Near Field Communication*. Technical Report, Ludwig-Maximilians-Universität (LMU) Munich, Germany, March 2007, LMU-MI-2007-1, ISSN 1862-5207. p. 3-5.

Fahrenbacher, K. (2011). Square COO: There's no value in NFC. *GigaOM*. 26.09.2011. <<http://gigaom.com/2011/09/26/square-mobilize-2011/>> (03 March 2012)

Ferscha, A., Holzmann, C. and Resmerita, S. (2006). The Key Knob. 26th IEEE International Conference on Distributed Computing Systems Workshops ICDCSW06, p.62-62.

Fishbach, A., Zhang, Y. and Kruglanski, A. W. (2007). The Dilution Model: How Additional Goals Undermine the Perceived Instrumentality of a Shared Path. *Journal of Personality and Social Psychology*, Vol 92(3), p. 389-401.

Fishbein, M. (1963). An investigation of relationships between beliefs about an object and the attitude toward that object. *Human Relations*, 16, 233-240.

Fishbein, M.: 1967a, A behavior theory approach to the relations between beliefs about an object and the attitude toward the object, in M Fishbein, (ed.), *Readings in Attitude Theory and Measurement*, pp. 389–400, Wiley, New York. (Cited by Hale, Householder, and Greene, 2002)

Fishbein, M: 1967b, A consideration of beliefs, and their role in attitude measurement, in M Fishbein, (ed.), *Readings in Attitude Theory and Measurement*, Wiley, New York. (Cited by Hale, Householder, and Greene, 2002)

Fishbein, M. & Ajzen, I. (1975). *Belief, attitude, intention, and behavior: An introduction to theory and research*. Reading, MA: Addison-Wesley.

Fogg, B. J. and Tseng, H. 1999. The elements of computer credibility. *Proceedings of CHI 99 Conference*. Pp. 80-87. (Cited by Kaasinen, 2005)

Foster K., Meijer, E., Schuh S. and Zabeck, M. A. (2011). *The 2009 Survey of Consumer Payment Choice*, Version of April 2011, Federal Reserve Bank of Boston.

Garbarino, E. and Johnson, M.S. (1999). The Different Roles of Satisfaction, Trust, and Commitment in Customer Relationships. *Journal of Marketing*, 63(2), p. 70-87

Garside, J. (2012). PayPal casts doubt on Near Field mobile payments systems. 28.02.2012. <<http://www.guardian.co.uk/technology/2012/feb/28/paypal-google-mobile-payments-system>> (23 March 2012)

Gartner (2012). *Gartner Says Worldwide Sales of Mobile Phones Declined 2 Percent in First Quarter of 2012; Previous Year-over-Year Decline Occurred in Second Quarter of 2009*. Engham, UK. 16.05.2012. <<http://www.gartner.com/it/page.jsp?id=2017015>> (19 May 2012)

Garvín, M. S., (2011). Network constellations for mobile payments - Influence of the leading partner on NFC-based mobile digital wallets. KTH, School of Architecture and the Built Environment (ABE). Department of Real Estate and Construction Management. Stockholm. p. 40-44. <<http://kth.diva-portal.org/smash/record.jsf?pid=diva2:491248>> (03 February 2012)

Gefen, D. (2000). E-commerce: the role of familiarity and trust, *Omega*, Volume 28, Issue 6, December 2000, Pages 725-737.

Google Wallet (2012a) FAQ. <<http://www.google.com/wallet/faq.html>> (5 April 2012)

Google Wallet (2012b) Launch Partners <<http://www.google.com/wallet/current-partners.html>> (5 April 2012)

Graham, F. (2011) Will NFC make the mobile wallet work? BBC News - Business. 06.10.11 <<http://www.bbc.co.uk/news/business-15201807>> (22 March 2012)

Ha, S. and Stoel, L. (2009) Consumer e-shopping acceptance: Antecedents in a technology acceptance model, *Journal of Business Research*, Volume 62, Issue 5, May 2009, Pages 565-571.

Hale, J. L., Householder, B. J. and Greene, K. (2002). Theory of reasoned action. In J. P. Dillard & M. Pfau (Eds.), *The persuasion handbook: Developments in theory and practice*. Eds. Sage Publications, Thousand Oaks, California (pp. 259–286).

Hall, S. P. and Anderson, E. (2009). Operating Systems for Mobile Computing. *Journal of Computing Sciences in Colleges*, vol. 25, issue 2, p. 64-71.

Hayashi, F. and Klee, E. (2003). Technology Adoption and Consumer Payments: Evidence from Survey Data, *Review of Network Economics*, 2, issue 2, number 8. p. 175-189 <<http://web.cenet.org.cn/upfile/31327.pdf>> (13 March 2012).

Hirson, R. (2012). The state of mobile payments: No more waiting on NFC. 21.03.2012. <<http://venturebeat.com/2012/03/21/405521/>> (18 April 2012)

Hitachi Consulting (2010). Targeting Millennial Generation Key to Growth in Emerging Consumer Payments. Hitachi Consulting, n.d. 21.10.2010. p. 1-6. <http://www.hitachiconsulting.com/files/pdfRepository/PR_CPPS_2010_vFINAL.pdf> (17 March 2012)

Honig, Z. (2011) A Week With Google Wallet (video). Engadget. 19.09.2011. <<http://www.engadget.com/2011/09/19/a-week-with-google-wallet-video/>> (06 March 2012)

International Telecommunication Union (2011). Key Global Telecom Indicators for the World Telecommunication Service Sector, 16.11.2011. <http://www.itu.int/ITU-D/ict/statistics/at_glance/KeyTelecom.html> (12 March 2012)

Johnson, M. D. and Katrichis, J. M. (1988). The Existence and Perception of Redundancy in Consumer Information Environments, *Journal of Consumer Policy*, 11, p. 131-157.

Jonker, N. (2005). Payment Instruments as Perceived by Consumers - a Public Survey, DNB Working Papers 053, Netherlands Central Bank, Research Department.

Juniper Research (2012) Press Release: More than 1 in 4 Mobile Users in the US and Western Europe will pay in-store using NFC by 2017. 30.05.2012. Hampshire, UK. <<http://www.juniperresearch.com/viewpressrelease.php?id=389&pr=315>> (03 June 2012)

Kaasinen, E. (2005) User Acceptance of Mobile Services - Value, Ease of Use, Trust and Ease of Adoption. VTT Information Technology, Helsinki. VTT Publications 566, <<http://www.vtt.fi/inf/pdf/publications/2005/P566.pdf>>

Kadhiwal, S., Usman, A. and Zulfiquar S. (2007). Analysis of mobile payment security measures and different standards, Computer Fraud & Security, Volume 2007, Issue 6, June 2007, p. 12-16.

Karnouskos, S. (2004). Mobile payment: A journey through existing procedures and standardization initiatives. IEEE Communications Surveys Tutorials, 6(4), p.44-66.

Karnouskos, S., Hondroudaki, A., Vilmos, A. and Csik, B. (2004). Security, trust and privacy in the secure mobile payment service, in: Proceedings of the 3rd International Conference on Mobile Business 2004, New York, NY.

Kharif, O. (2012). Google Said To Rethink Wallet Strategy Amid Slow Adoption. Bloomberg. 03.21.2012. <<http://www.bloomberg.com/news/2012-03-21/google-said-to-rethink-wallet-strategy-amid-slow-adoption.html>> (05 April 2012)

Kindberg, T., Sellen, A. and Geelhoed, E. (2004). Security and Trust in Mobile Interactions: A Study of Users' Perceptions and Reasoning. UbiComp 2004: Ubiquitous Computing. Lecture Notes in Computer Science. p. 196-213.

King, W. R. and He, J. (2006) A meta-analysis of the technology acceptance model, Information & Management, Volume 43, Issue 6, p. 740-755.

Koufaris, M. (2002). Applying the Technology Acceptance Model and Flow Theory to Online Consumer Behavior. Information Systems Research, 13(2), p. 205-223.

Langer, E. J. (1989). *Mindfulness reading*. Reading, MA: Merloyd Lawrence Books. (Cited by Hale, Householder, and Greene, 2002)

Lederer, A. L., Maupin, D. J., Sena, M. P. and Zhuang, Y. (2000). The technology acceptance model and the World Wide Web, Decision Support Systems, Volume 29, Issue 3, October 2000, p. 269-282.

Legris, P., Ingham, J. and Pierre, C. (2003). Why do people use information technology? A critical review of the technology acceptance model, Information & Management, Volume 40, Issue 3, p. 191-204.

Linck, K., Pousttchi, K. and Wiedemann, D. G. (2006): Security Issues in Mobile Payment from the Customer Viewpoint. Published in: 14th European Conference on Information Systems (ECIS), Göteborg/Schweden, Juni 2006 : pp. 1-11.

Madlmayr G., Langer J. and Scharinger J. (2008). A Secure Near Field Communication based Mobile Payment System, Proceedings der 3. Konferenz Mobilität und Mobile Informationssysteme, München.

Maguire, M. (2001). Methods to support human-centred design. *International Journal of Human-Computer Studies*, Volume 55, Issue 4, p. 587-634.

Mallat, N. (2006). Exploring consumer adoption of mobile payments – A qualitative study, *The Journal of Strategic Information Systems*, Volume 16, Issue 4, December 2007, p. 413-432.

Massoth, M., Bingel, T. (2009). Performance of Different Mobile Payment Service Concepts Compared With a NFC-Based Solution. *Proceedings of the 4th International Conference on Internet and Web Applications and Services*, p. 205-210. <<http://nfclab.isikun.edu.tr/papers/NFCResearchFramework.pdf>> (03 March 2012)

McCarthy, J. (2011) Google licenses Visa's payWave technology. 19.09.2011. <<http://blog.visa.com/2011/09/19/google-licenses-visa%E2%80%99s-paywave-technology/>> (04 April 2012)

Mittal, V., Katrichis J. M. , Forkin, F., Mark, K. (1993). Does Satisfaction With Multi-Attribute Products Vary Over Time? A Performance Based Approach, in *Advances in Consumer Research*, Vol. 21, Chris T. Allen and Deborah Roedder John, eds. Provo, UT: Association for Consumer Research, p. 412-417.

Myers, J. H. & Mark I. A. (1968) Determining Buying Attitudes: Meaning and Measurement, *Journal of Marketing*, 32, Oct., p. 13-20.

Nelson, P. (1999). "Multiattribute Utility Models." In P. E. Earl and S. Kemp (eds.), *Consumer Research and Economic Psychology*. Northampton, MA: Edward Elgar, pp. 392–400.

NFC Forum, The (2012a). NFC Forum Tag Type Technical Specifications. <http://www.nfc-forum.org/specs/spec_list/#tagtypes> (22 March 2012)

NFC Forum, The (2012b). About the Forum <<http://www.nfc-forum.org/aboutus/>> (23 March 2012)

Nielsen (2011). State of the Media: The Mobile Media Report Q3 2011. p. 2. <<http://nielsen.com/content/dam/corporate/us/en/reports-downloads/2011-Reports/state-of-mobile-Q3-2011.pdf>> (17 February 2012)

Norman, D. A. 1998. *The Invisible Computer*. MIT Press, Cambridge, MA. (Cited by Kaasinen, 2005)

Norton, K. (2006). Contactless Payment Comes to Cell Phones. *BusinessWeek*. 21.11.2006. <http://www.businessweek.com/globalbiz/content/nov2006/gb20061121_811258_page_2.htm> (23 May 2012)

Notani, A. S. (1998). Moderators of perceived behavioral control's predictiveness in the theory of planned behavior: A meta-analysis. *Journal of Consumer Psychology*, 7, p. 247-271.

Nysveen, H., Pedersen, P. E., and Thorbjørnsen, H. (2005). Intentions to Use Mobile Services: Antecedents and Cross-Service Comparisons. *Journal of the Academy of Marketing Science*, volume 33, number 3, p. 330-346.

Ondrus, J. and Pigneur, Y. (2005). A Disruption Analysis in the Mobile Payment Market. In Proceedings of the Proceedings of the 38th Annual Hawaii International Conference on System Sciences (HICSS'05) - Track 3 - Volume 03 (HICSS '05), Vol. 3. IEEE Computer Society, Washington, DC, USA.

Ondrus, J. and Pigneur, Y. (2006). Towards a holistic analysis of mobile payments: A multiple perspectives approach, *Electronic Commerce Research and Applications*, Volume 5, Issue 3, Autumn 2006, p. 246-257.

Patauner, C., Witschnig, H., Rinner, D., Maier, A., Merlin, E. and Leitgeb, E. (2007) High Speed RFID/NFC at the Frequency of 13.56 MHz. *EURASIP Workshop on RFID*. p. 1-4. <<http://www.eurasip.org/Proceedings/Ext/RFID2007/pdf/s1p4.pdf>> (22 February 2012)

Paus, A. (2007). Near Field Communication in Cell Phones. Seminararbeit Ruhr-Universität Bochum.

<http://imperia.rz.rub.de:9085/imperia/md/content/seminare/itsss07/near_field_communication_in_cell_phones.pdf> (23 March 2012)

Pavlou, P. A., (2003). Consumer acceptance of electronic commerce: Integrating trust and risk with the technology acceptance model. *International Journal of Electronic Commerce*, Vol. 7, No. 3, p. 101-134.

Plouffe, C. R., Hulland, J. S. and Vandenbosch, M. (2001). Research Report: Richness Versus Parsimony in Modeling Technology Adoption Decisions- Understanding Merchant Adoption of a Smart Card-Based Payment System. *Info. Sys. Research* 12, p. 208-222.

Pousttchi, K. (2003). Conditions for acceptance and usage of mobile payment procedures. In *Second International Conference on Mobile Business*. Citeseer, pp. 201-210.

Rao, L. (2011). PayPal Tests In-Store NFC Payments App With Swedish Retailers, Similar Mobile 'Experiments' To Roll Out Soon. 20.12.2011. <<http://techcrunch.com/2011/12/20/paypal-tests-in-store-nfc-payments-app-with-swedish-retailers-similar-mobile-experiments-to-roll-out-soon/>> (12 April 2012)

Reardon, M. (2011). Google Wallet, Offers make debut (live blog). At a press conference in New York, company takes the wraps off Google Wallet and Google Offers. CNET is live-blogging the event. CNET news. 26.05.2011. <http://news.cnet.com/8301-30686_3-20066227-266.html> (9 March 2012)

Rebello, J. (2011). US Wireless Carriers Partner with Big Credit Card Companies, Boosting Cell Phone NFC Market. iSupply. <<http://www.isuppli.com/Mobile-and-Wireless-Communications/News/Pages/US-Wireless-Carriers-Partner-with-Big-Credit-Card-Companies-Boosting-Cell-Phone-NFC-Market.aspx>> (22 March 2012)

Resnick, P., Kuwabara, K., Zeckhauser, R. and Friedman, E. (2000). Reputation systems. *Commun. ACM* 43, 12 (December 2000), p. 45-48.

RFID.net. (2012). Intelleflex BAP Tags Shatter Read Distance Records with 120+ Meters. 22.04.2012. <http://rfid.net/product-listing/reviews/322-intelleflex-bap-tags-shatter-read-distance-records-with-120-meters#Battery_Assisted_Passive_BAP_RFID_tags> (23 April 2012)

Schuh, S. and Stavins, J. (2010). Why are (some) consumers (finally) writing fewer checks? The role of payment characteristics, *Journal of Banking & Finance*, Volume 34, Issue 8, August 2010, p. 1745-1758.

Segan, 2011; What is NFC, and Why Should You Care?." PCMag.com 17 Nov. 2010: n. pag. Web. 19 Apr 2011. <<http://www.pcmag.com/article2/0,2817,2372849,00.asp>>

Sheppard B. H., Hartwick, J. and Warshaw, P. R., (1988). The Theory of Reasoned Action: A Meta-Analysis of Past Research with Recommendations for Modifications and Future Research. *Journal of Consumer Research* , Vol. 15, No. 3 (Dec., 1988), pp. 325-343

Shneiderman, B. (2000). Designing trust into online experiences. *Communications of the ACM*, 43(12), p. 57-59.

Siau, K., Sheng, H., Nah, F., and Davis, S. (2004). A qualitative investigation on consumer trust in mobile commerce. *International Journal of Electronic Business*, 2(3), 283-300. (cited by Mallat, 2006)

Smart Card Alliance, The. (2007) Proximity Mobile Payments: Leveraging NFC and the Contactless Financial Payments Infrastructure. Publication Number: CPC-07002, p. 5-37. <http://www.smartcardalliance.org/resources/lib/Proximity_Mobile_Payments_200709.pdf> (2 February 2012)

Stalfors, P. and Nykvist, R. (2001). Consumer acceptance of mobile payment services. An empirical study of factors explaining Swedish consumers' intention to use mobile payment services. Handelshogskolan Goteborgs Universitet.

Sutherland, R. (2011). Perspective is everything at 9:45m. TEDxAthens Talk. Uploaded May 2012. <http://www.ted.com/talks/rory_sutherland_perspective_is_everything.html> (02 June 2012)

Sutter, J. (2011). Our future: Empty pockets, except for our phones. *Digital Biz*, CNN. 10.10.2011. <<http://edition.cnn.com/2011/10/09/tech/mobile/google-mobile-wallet/index.html>> (9 March 2012)

Sutton, S., French, D. P., Hennings, S. J., Mitchell, J., Wareham, N. J., Griffin, S., Hardeman, W., Kinmonth, A. L. (2003). Eliciting Salient Beliefs in Research on the Theory of Planned Behaviour: The Effect of Question Wording. *Current Psychology: Developmental, Learning, Personality, Social*. Fall 2003, Vol. 22, No. 3, p. 234–251.

Telegraph (2012). PayPal claims its iPhone and Android shopping app beats NFC chips. 31.05.2012. <www.telegraph.co.uk/technology/mobile-phones/9302091/PayPal-claims-its-iPhone-and-Android-shopping-app-beats-NFC-chips.html> (05 June 2012)

Temsamani, K., (2011). A Look Back at 2011 - Google Mobile Ads Blog. 19.12.2011 <<http://googlemobileads.blogspot.com/2011/12/look-back-at-2011.html>> (01 March 2012).

Thompson, C. (2012). Near field communication the next mobile boost? – USAtoday.com. 08.01.2012 <<http://www.usatoday.com/tech/news/story/2012-01-08/cnbc-near-field-communication-mobile/52443756/1>> (03 March 2012)

Tversky, A. (1972). Elimination by aspects: A theory of choice, *Psychological Review*, 79, p. 281–299.

Venkatesh V., Davis F.D. (2000). A theoretical extension of the technology acceptance model: four longitudinal field studies, *Management Science* 46, 2, 2000, p. 186–204.

Venkatesh, V. (2000). Determinants of Perceived Ease of Use: Integrating Control, Intrinsic Motivation, and Emotion into the Technology Acceptance Model. *Information Systems Research*. Vol. 11, No. 4, December 2000, p. 342–365.

Venkatesh, V., Morris, M. G., Davis, G. B., Davis, F. D. (2003). User Acceptance of Information Technology: Toward a Unified View. *MIS Quarterly* , Vol. 27, No. 3, p. 425-478.

Want, R. (2006) An Introduction to RFID Technology, *IEEE Pervasive Computing*, vol. 5, no. 1, Jan.-Mar. 2006, pp. 25-33. <<http://w.thispervasiveday.com/documents/articles-perspectives/an-introduction-to-rfid-technology.pdf>> (07 March 2012)

Wilkie, W. L., Pessemier, E. A. (1973). Issues in Marketing's Use of Multi-Attribute Attitude Models, *Journal of Marketing Research*, 10, November, p. 428-441

World Bank, (2012) Data, Graph. Mobile cellular subscriptions (per 100 people) <<http://data.worldbank.org/indicator/IT.CEL.SETS.P2/countries?display=graph>> (03 February 2012)

Wu, J. and Wang, S. (2005) What drives mobile commerce?: An empirical evaluation of the revised technology acceptance model, *Information & Management*, Volume 42, Issue 5, July 2005, p. 719-729.