

Enhancing Creativity in Global Virtual Teams

Anders B. Fløystad
Aleksandra Maria Kjemhus

SNF



SNF

SAMFUNNS- OG NÆRINGS-LIVSFORSKNING AS

- er et selskap i NHH-miljøet med oppgave å initiere, organisere og utføre eksternt-finansiert forskning. Norges Handelshøyskole og Stiftelsen SNF er aksjonærer. Virksomheten drives med basis i egen stab og fagmiljøene ved NHH.

SNF er ett av Norges ledende forskningsmiljø innen anvendt økonomisk-administrativ forskning, og har gode samarbeidsrelasjoner til andre forskningsmiljøer i Norge og utlandet. SNF utfører forskning og forskningsbaserte utredninger for sentrale beslutningstakere i privat og offentlig sektor. Forskningen organiseres i programmer og prosjekter av langsiktig og mer kortsiktig karakter. Alle publikasjoner er offentlig tilgjengelig.

SNF

CENTRE FOR APPLIED RESEARCH AT NHH

- is a company within the NHH group. Its objective is to initiate, organize and conduct externally financed research. The company shareholders are the Norwegian School of Economics (NHH) and the SNF Foundation. Research is carried out by SNF's own staff as well as faculty members at NHH.

SNF is one of Norway's leading research environment within applied economic administrative research. It has excellent working relations with other research environments in Norway as well as abroad. SNF conducts research and prepares research-based reports for major decision-makers both in the private and the public sector. Research is organized in programmes and projects on a long-term as well as a short-term basis. All our publications are publicly available.

SNF Report No. 05/18

Enhancing Creativity in Global Virtual Teams

*The relationship between communication tools, conflict and
creative output*

by

**Anders B. Fløystad
Aleksandra Maria Kjemhus**

SNF Project No. 4285
Cross-Border Value Creation

The report is written as part of the research project *Cross-Border Value Creation* at SNF funded by Research Council Norway, Deloitte, DNB, Laerdal Medical and Telenor.

Centre for Applied Research at NHH
BERGEN OCTOBER 2018

© This copy has been drawn up by agreement with KOPINOR, Stenergate 1, NO-0050 Oslo. The production of further copies without agreement and in contravention of the Copyright Act is a punishable offence and may result in liability to compensation.

ISBN 978-82-491-0983-8 Printed version
ISBN 978-82-491-0984-5 Online version
ISSN 0803-4036

Preface

This master thesis is written at the Norwegian School of Economics and is a part of the Future Oriented Corporate Solutions (FOCUS) programme. This thesis is written by the authors as part of the master program in Economics and Business Administration, majoring in International Business.

The development of this thesis has presented us with a myriad of challenges, which has provided us with newfound knowledge about quantitative research, critical thinking and exposed us to the existing literature on this thesis' subject.

We would like to direct a special thanks to Vidar Schei and Therese Sverdrup for invaluable direction and cooperation over the past months. Through fast and useful feedback they have guided our endeavour into to the world of scientific inquiry and without their guidance this thesis would not hold the same quality. Additional thanks are directed at X – Culture, and especially Vasyl Taras for his generous support and contribution of the X – Culture data, which has made this study possible. We also thank the generosity and spirit of the FOCUS program that has contributed through lectures, meetings and their offices during the writing of this thesis. Finally, we must thank our faithful dog Leo, who has kept our spirits up and taken his role as a therapy dog very seriously.

Contents

PREFACE

CONTENTS

LIST OF TABLES

1. INTRODUCTION	1
1.1 BACKGROUND	1
1.2 PURPOSE	2
1.3 STRUCTURE	3
2. THEORY	4
2.1 GLOBAL VIRTUAL TEAMS	4
2.2 CORE CONCEPTS AND THEORIES	6
2.2.1 CREATIVITY	6
2.2.2 ONLINE COMMUNICATION TOOLS	7
2.2.3 CONFLICT	9
2.3 COMMUNICATION AND CREATIVITY	11
2.4 COMMUNICATION AND CONFLICT	13
2.5 CONFLICT AND CREATIVITY	16
2.6 DEVELOPMENT OF HYPOTHESES	18
2.6.1 COMMUNICATION AND CREATIVITY	18
2.6.2 COMMUNICATION AND CONFLICT	19
2.6.3 CONFLICT AND CREATIVITY	20
2.6.4 MEDIATION	21
2.7 RESEARCH MODEL	22
3. METHOD	24
3.1 RESEARCH DESIGN	24
3.1.1 RESEARCH APPROACH	24
3.1.2 X-CULTURE	25
3.1.3 PARTICIPANTS	27
3.1.4 PROJECT TIMELINE	29
3.2 DATA COLLECTION	30
3.2.1 DEPENDENT VARIABLE	30
3.2.2 INDEPENDENT VARIABLES	31

3.2.3	PROCESS VARIABLES	32
3.3	DATA ANALYSIS	32
3.3.1	PREPARING DATA	32
3.3.2	AGGREGATION	33
3.3.3	MULTIPLE REGRESSION	35
3.3.4	MEDIATION ANALYSIS	35
3.4	RESEARCH QUALITY	36
3.4.1	VALIDITY	36
	INTERNAL VALIDITY	36
	CONSTRUCT VALIDITY	37
	EXTERNAL VALIDITY	38
3.4.2	RELIABILITY	39
3.4.3	APPROVAL AND ANONYMITY	40
4.	RESULTS	41
4.1	CONDITIONS FOR MULTIPLE REGRESSION AND MEDIATION ANALYSIS	41
4.1.1	MISSING VALUES	41
4.1.2	OUTLIERS	42
4.1.3	NORMAL DISTRIBUTERS ERRORS AND LINEARITY	42
4.1.4	MULTICOLINEARITY	43
4.1.5	HOMOSCEDASTICITY	43
4.1.6	AUTOCORRELATION	44
4.2	DESCRIPTIVE STATISTICS	44
4.3	HYPOTHESES TESTING	47
4.3.1	MULTIPLE REGRESSION	47
4.3.1.1	The relationship between communication richness and creative output	47
4.3.1.2	The relationship between communication richness and conflict	48
4.3.1.3	The relationship between conflict and creative output	49
4.3.2	MEDIATION ANALYSIS	51
4.3.2.1	Mediation: high richness communication	51
4.3.2.2	Mediation: high richness communication	53
4.3.3	SUMMARY OF THE HYPOTHESES TESTING	55
4.4	ADDITIONAL ANALYSIS	56
4.4.1	LOW RICHNESS COMMUNICATION AND PERCEIVED CREATIVE OUTPUT	56
4.4.2	HIGH RICHNESS COMMUNICATION AND PERCEIVED CREATIVE OUTPUT	57

5. DISCUSSION	59
5.1 THEORETICAL IMPLICATIONS	60
5.1.1 RELATIONSHIPS BETWEEN COMMUNICATION AND CREATIVITY	60
5.1.2 RELATIONSHIPS BETWEEN COMMUNICATION AND CONFLICT	61
5.1.3 RELATIONSHIPS BETWEEN CONFLICT AND CREATIVITY	62
5.1.4 MEDIATING EFFECTS	63
5.1.5 SUMMARY	63
5.2 MANAGERIAL IMPLICATIONS	64
5.3 LIMITATIONS AND FURTHER RESEARCH	64
5.3.1 MEASUREMENT CHALLENGES	64
5.3.2 CATEGORISATION OF COMMUNICATION TOOLS	66
6. CONCLUSION	68
7. REFERENCES	69
8. APPENDIX	82
APPENDIX 3-1: NUMBER OF SCHOOLS AND PARTICIPANTS BY COUNTRY	82
APPENDIX 3-2: PREACHER AND HAYES' MEDIATION MODEL NUMBER 4	83
APPENDIX 4-1: TESTING THE CONDITIONS FOR MULTIPLE REGRESSION AND MEDIATION	84
APPENDIX 4-2: ADDITIONAL ANALYSIS	87

List of figures

<i>Figure 1-1: Research model</i>	3
<i>Figure 2-1: Research model with hypotheses</i>	22
<i>Figure 3-1: Graph of participants by country</i>	29
<i>Figure 3-2: Project timeline</i>	30
<i>Figure 4-1: Low richness mediation</i>	51
<i>Figure 4-2: High richness mediation</i>	53

List of tables

<i>Table 2-1: Categorisation based on media richness</i>	<i>9</i>
<i>Table 2-2: Summary of hypotheses.....</i>	<i>23</i>
<i>Table 3-1: Descriptive statistics.....</i>	<i>28</i>
<i>Table 3-2: rwg and ICC scores.....</i>	<i>34</i>
<i>Table 4-1: Descriptive statistics - variables.....</i>	<i>45</i>
<i>Table 4-2: Correlation matrix.....</i>	<i>46</i>
<i>Table 4-3: Multiple regression: Creative output.....</i>	<i>48</i>
<i>Table 4-4: Multiple regression: Conflict variables.....</i>	<i>49</i>
<i>Table 4-5: Multiple regression: Conflict and communication on creative output.....</i>	<i>50</i>
<i>Table 4-6: Path coefficients: Low richness on creative output.....</i>	<i>52</i>
<i>Table 4-7: Confidence intervals: Low richness mediation.....</i>	<i>53</i>
<i>Table 4-8: Path coefficients: High richness communication on creative output.....</i>	<i>54</i>
<i>Table 4-9: Confidence intervals: High richness mediation.....</i>	<i>55</i>
<i>Table 4-10: Summary of hypotheses testing.....</i>	<i>56</i>
<i>Table 4-11: Path coefficients: Low richness communication and perceived creative output (mediation).....</i>	<i>57</i>

1. Introduction

1.1 Background

Teams have increasingly been used by organisations to solve complex tasks (Salas, Cooke, & Rosen, 2008). In 2012, 46 % of organisations used virtual teams (Society for Human Resource Management, 2012). Furthermore, 72 % of organisations reported that brainstorming solutions was the most successful activity that virtual teams were used for (Society for Human Resource Management, 2012). There has however historically been a challenge to get diverse teams who are geographically spread to work together (Mathieu, Maynard, Rapp, & Gilson, 2008). Teams comprised of diverse individuals spread over geographical distances face multiple challenges for successful cooperation (Schahaf, 2008; Curşeu, Schalk, & Wessel, 2008; Klitmøller & Luring, 2013), and are more prone to conflict than co-located teams (Milliken & Martins, 1996; Hinds & Bailey, 2003). These global virtual teams have been used to increase creativity by harnessing diversity (Zackaria, Amelinckx, & Wilemon, 2004).

Earlier research into global virtual teams has mainly focused on inputs, trust, virtuality, technology and leadership's impact on virtual team efficiency and performance (Gilson, Maynard, Jones Young, Vartiainen, & Hakonen, 2015). A study by Han, Hiltz, Fjermestad and Wang (2011) found that the richness of communication tools used for an initial meeting did not impact creativity when virtual teams subsequently communicated exclusively via asynchronous text. Nonetheless, the literature on the effects of communication on creativity in global virtual teams has received sparse research attention (Gilson et al., 2015). Therefore, due to the prevalence of virtual teams in organisation and limited research on creativity in global virtual teams, we aim to further illuminate the relationship between communication and creativity in global virtual teams.

1.2 Purpose

In this study we are going to examine whether there is a relationship between the richness and frequency of online communication and the creative output in global virtual teams. Communication is the cornerstone of global virtual teams, since online communication tools facilitates information exchange, and communication is an important contributor to the occurrence of conflict (Putnam, 1988; Cramton, 2001). In addition, today's multinational organisations use global virtual teams to solve complex challenges, and the creativity and viability of the solutions developed by global virtual teams is of great importance to the competitiveness and success of organisations. It is therefore interesting to examine if the richness and frequency of communication plays a role when team's wish to produce creative output. We therefore ground our study's problem in the following question:

Does communication frequency and richness play a role in determining what makes global virtual teams creative?

We base our examination of the problem by conducting a quantitative analysis based on data gathered by the X-culture programme in the spring of 2017. The X-culture project annually enrolls bachelor and master students from around the world to solve a complex business challenges in a short timeframe. During the project the student teams have to communicate with each other using their online communication tools of choice, and one of their evaluating outcomes is the creativity of their solution - which serves as our measures of communication richness and frequency, as well as creativity. The business challenge is based on a real life problem faced by partner companies, and thus represents a complex challenge for the student teams.

1.3 Structure

The paper is divided into different chapters that aim to illuminate the research question in the best way possible. We will start by defining global virtual teams and present our core concepts: creativity, online communication tools and conflict. Thereafter we elaborate on how the different theoretical core concepts are linked together as shown in the research model (figure 1-1) below. The theory aims to give the reader a good overview of the phenomenon we are studying and provide a rationale for our hypothesis. We will subsequently present the methodology we use, discuss the quantitative data and elaborate on how we create the variables used to test our hypotheses. In the fourth chapter we will present our main findings, before we finish by discussing the findings relevance for the literature and organisations. To conclude we will discuss our study's limitations and further research that our study prompts.

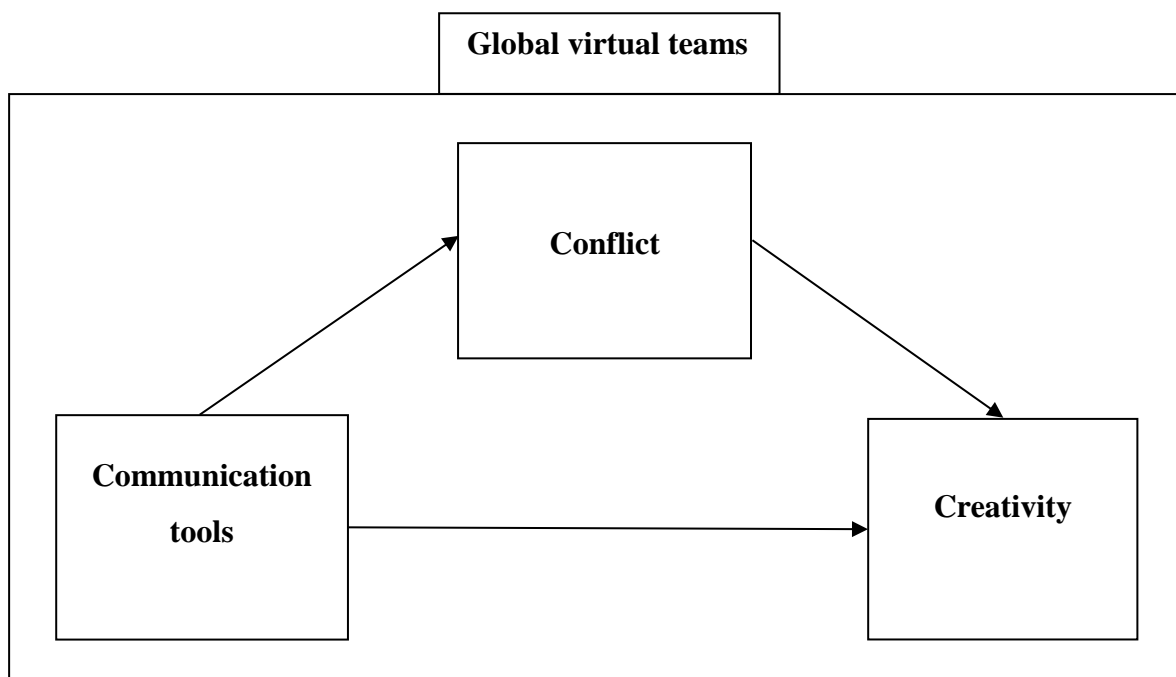

Figure 1-1: Research model

2. Theory

We will start chapter 2 by introducing the literature of global virtual teams, which is an essential condition for the teams studied in this paper. Thereafter we introduce the core concepts, which include creativity, communication tools and conflict. Consequently, we will dive into how the different theoretical concepts (creativity, communication tools and conflict) are linked together, presenting literature and empirical research, which supports the different paths in our model. We will finish off chapter 2 by presenting our hypothesis.

2.1 Global virtual teams

The increasing trend of virtualisation of teamwork has been made possible by advances in computer mediated communication and changing organisational structures. Already in 2002 more than 60 % of professionals to some extent worked virtually in the new millennium (Kanawattanachai & Yoo, 2002). Furthermore, in 2012 46 % of organisations and 66 % of organisations with multinational operations used virtual teams (Society for Human Resource Management, 2012). With the rise of virtual teams, they have subsequently received increasing attention from researchers over the past decade (Gilson et al., 2015). Globalisation of the workforce available to companies has caused the right employees for a team to a larger degree be situated worldwide (Lipnack & Stamps, 1999). Thus, companies to a larger extent utilise a global talent pool to create virtual teams, so we can to a larger degree talk about global virtual teams. Global virtual teams are well defined as a group of people that strive towards a common goal, are geographically dispersed and communicate with each other through the use of information and communication technology (Axtell, Fleck, & Turner, 2004; Martins, Gilson, & Maynard, 2004; Curşeu et al., 2008). Advances in communication tools has caused many organisational teams to have some degree of virtuality, but the above definition on global virtual teams diverges from the theme of virtuality by stating that all team communication is mediated through online communication tools.

The advantage of global virtual teams is that they offer the flexibility to create teams that irrespective of geographic location, bring together the best skills and knowledge to increase organisational performance and problem solving ability (Townsend, DeMarie, & Hendrickson, 1998). An employee may be part of multiple teams, as geographic location is no longer a prerequisite for team membership. Research also indicates that global virtual teams discourage race, sex and age discrimination (Bergiel, Bergiel, & Balsmeier, 2008). A further advantage of global virtual teams are that they allow employees to work from home which can result in reduced CO2 emissions, travel cost and time used on travel. A global virtual team ensures twenty-four-hour service coverage by utilising team members spread over multiple time zones. Some would even go so far as to say that using global virtual teams is essential in order to compete in the global economy (Lu, House, Watson-Manheim, & Matzkevich, 2005). Global virtual teams are by nature diverse and heterogeneous and are thus well suited for tasks that require some form of creative output (Bergiel et al., 2008). The benefit of diversity in global virtual teams is that it allows to tap into very different knowledge and experience pools, providing more points of view, which in turn is important in order to improve decision-making (Schahaf, 2008). Lastly, diversity is a key element for fostering creativity and innovation, and is seen as a success-factor for firms who wish to obtain competitive advantage (Bassett-Jones, 2005; Gassmann 2001). To conclude, there are many advantages of global virtual teams due to their diverse and flexible nature.

In spite of the advantages of global virtual teams, there are numerous added complexities when a heterogeneous team communicates exclusively via online communication tools. The cost of interaction increases, and potentially more communication challenges arise due to the reduction of vocal and non-verbal communications (Hollingshead, McGrath, & O'Connor, 1993) as well as the increased communication barriers from cultural and language differences. A study by Schahaf (2008) found that large differences in cultural and language differences can lead to miscommunications that negatively impact cohesion, trust and team identity. She also points out that language barriers produce communication challenges, due to a lack of written and spoken accuracy. This causes team members to spend more time encoding and decoding messages, and increases the cost and time associated with communicating. Global virtual teams also take longer to reach decisions than their co-located counterparts (Kiesler, Zubrow, Moses, & Geller, 1985; McGuire, Kiesler, & Siegel, 1987; Weisband 1992). In addition, team members are at times spread across different time zones, which complicates team logistics.

Furthermore, Joinson (2002) points out that not all individuals have the psychological make-up to thrive in a virtual work-environment. Despite potential pitfalls and downsides, it seems that global virtual teams are becoming increasingly common when organisations want to create innovations (Jones, 2009; Wuchty, Jones and Uzzi 2007). Therefore it is crucial to understand how to exploit the potential of global virtual teams while mitigating the risk associated with the added complexities.

2.2 Core concepts and theories

The core concepts and theories are the foundation of our model. In this section we will provide a short literature review of creativity, communication tools and conflict, which sets the stage for our analysis.

2.2.1 Creativity

In today's fast paced world, creativity and the ability to learn new skills quickly are essential for the further survival of companies. But what is really creativity? Amabile (1996) suggests that creativity can be defined as the production of novel and useful ideas, which can be performed as a team or an individual activity. We agree that this definition holds merit and relevance in the context of this paper.

Pinpointing exactly what makes a group or individual creative has proved challenging. Hunter, Bedell and Mumford (2007) have researched whether the environmental and social climates acts as a facilitator or a hindrance for creativity, with various findings. Nevertheless, they did find that external environmental factors provide physical stimuli which can enhance creativity within individuals and teams. Furthermore, social dimensions such as safety, trust, goal clarity and intellectual stimulation can positively affect creativity (Amabile, 1996; Amabile, Conti, Coon, Lazenby, & Herron, 1996). Amabile (1983) argues that creativity is enhanced by particular personality traits, which she argues has a positive correlation with creative performance. In her framework she argues these characteristics include domain – relevant skills, factual knowledge, technical skills and talents in the specific domain in question.

A way to foster creativity is by the use of teams (Thatcher & Brown, 2010). Some researchers even propose that teams are more likely than individuals to develop innovative solutions (Singh & Fleming, 2010; Uzzi, Mukherjee, Stringer, & Jones 2013). Team creativity can be achieved when team members collaborate and generate new ideas (Campbell 1960). In order to achieve this, several conditions are important, especially working in psychological safe environments (Zhang, Fang, Wei, & Chen, 2010) and being able to share ideas and concepts among team members (Kirkman, Rosen, Tesluk, & Gibson, 2004). In teams where these attributes are not present however, certain team members can dominate the creative process, especially when factors such as time pressure and technical difficulties are present (Ocker 2015).

The literature proposes that diversity and divergent thinking are positive attributes towards creativity (Gilson et al., 2015), particularly in terms of knowledge and expertise (Paulus, 2009). Virtual teams have often been used to increase creativity by harnessing diversity (Zakaria et al., 2004). Additionally, a positive attitude among team members towards demographic diversity is more likely to result in the production of high - quality ideas (Nakui, Paulus, & Van der Zee, 2006). Nonetheless, it has historically been a challenge to get diverse teams who are geographically spread to work together (Mathieu et. al., 2008).

2.2.2 Online communication tools

Online communication tools are at the core of the functioning of global virtual teams (Gibson & Cohen, 2003). Over the years, a myriad of different online communication tools have emerged to suit all forms of exchange between groups and individuals. Global virtual teams are separated by distance, therefore they exclusively use online communication tools to communicate with each other. In cases with little to no communication or inadequate exchange of information, the global virtual team will experience that creativity is hampered (Nemiro, 2004). Another characteristic of communication in global virtual teams is that information is often exchanged asynchronously, meaning at different times (Klitmøller & Luring, 2013), which can be caused by team members living in different time zones, forming a delay when messages are read and answered. This can entail delays in important stages of the teams work in regards to feedback and confirmation, which can lead to misunderstandings and miscommunication (Jarvenpaa, Knoll & Leidner, 1998). To conclude, the types of

communication tools available to global virtual teams are comprised of different text, audio and video based solutions that all share a commonality: the inability to offer the same communication richness as traditional face-to-face communication (Nemiro, 2004).

Media richness theory

Different online communication tools differ in the richness of information that can be conveyed. This is based on the feedback capabilities, the communication channels offered, social presence and degree of non-verbal information filtering (Suh, 1999). The more a medium embeds these characteristics, the richer it is. The richest communication tools allow mutual instant feedback, communication through multiple channels such as body language, tone of voice and emotions, and thus a higher degree of social presence (Daft & Lengel, 1986; Yoo & Alavi, 2001). The less of these characteristics a communication tool embodies the leaner it can be considered. A commonly mentioned lean communication tool is email, since it does not allow for any body language, tone of voice and does not easily convey emotions. The choice of which media to use in what context has received a lot of study, and a common classification of what type of media is suited for what purpose was first developed by Daft and Lengel (1986). From their work stems media richness theory, which proposes that rich communication mediums are well suited for sharing equivocal knowledge (Daft & Lengel, 1986; Majchrzak, Rice, Malhotra, King, & Ba, 2000; Maznevski & Chudoba, 2000; Nemiro, 2004), whereas leaner mediums are more suited for sharing routine and canonical knowledge (Daft & Lengel, 1986; Klitmøller & Luring, 2013).

Categorisation of communication tools

When grouping online communication mediums, a common approach is to divide communication tools based on their media richness (Nemiro, 2004) We have grouped them into two main categories, based on how many channels of information they offer, and their degree of social presence. This categorization is based on Nemiro's (2004, p140) categorisation of common online communication tools. (i) Low richness, asynchronous communication tools only allow for communication via written text. (ii) Rich and synchronous communication tools offer video and/or voice communication, providing a closer resemblance to richness of face-to-face communication in a virtual setting.

Table 2-1: Categorisation based on media richness

Media richness group	Synchronicity	Communication channels	Examples
Low	<i>Asynchronous</i>	<i>Text</i>	<i>Message board, email, instant messaging</i>
High	<i>Synchronous</i>	<i>Video and/or audio</i>	<i>Audio- and video-conferencing</i>

2.2.3 Conflict

Conflict can generally be defined as “a process that commences when an individual or a team perceives differences and oppositions between themselves and another individual or team about interests, resources, beliefs, values or practices that matter to them” (De Dreu and Gelfand, 2008, p. 6). In the context of global virtual teams, diversity is high and all communication is mediated. As a result, global virtual teams are more vulnerable to misunderstandings, which can be a source to conflict. This is supported by Milliken, Bartel and Kurtzberg (2003) who found that individuals with interpersonal differences might experience misunderstanding more frequently and value each other’s contribution less, which they state is particularly salient in highly diverse groups. Other researchers also support this argument, and have found that diversity can lead to conflict because of coordination and communication difficulties (Kirton 1976, 1989). Furthermore, researchers have found that there are many communication challenges when diverse individuals interact using online communication tools, which in turn can lead to further misunderstandings (Andres, 2012; Schahaf, 2008; Klitmøller & Lauring 2013) and may translate into another source of conflict. As a conclusion, global virtual teams are likely to experience conflicts due to their diverse nature and their limitations in communication options.

In organisational research, team conflicts can be divided into three groups of conflicts. These conflicts can be related to tasks, relationships and processes (Jehn, 1997). Below we will describe the different types of conflicts in more detail.

Relationship conflict

Relationship conflict focuses on interpersonal relationships where conflict arises from personal differences and personality traits (Jehn 1997). These conflicts are typically characterised by annoyance and tension among group members. Jehn, Northcraft and Neale (1999) found that diverse teams experienced increased relationship conflicts, especially in groups that are diverse in terms of gender and ethnicity.

Task conflict

Task conflict is related to disagreements regarding the task at hand. Task conflicts can thus be characterised by opposing goals and disagreements regarding how to solve a certain task (Jehn, 1997). Diversity can be a factor that increases task conflict (Pelled, Eisenhardt & Xin 1999).

Process conflict

Process conflict arises from challenges related to work attribution, allocation of tasks and resources as well as scheduling meetings (Jehn, 1997; Marks, Mathieu and Zaccaro, 2001). Global virtual teams are especially vulnerable towards process conflict as the teams can be spread across various time zones, which can cause difficulties scheduling a meeting that is coherent with everyone's time schedule. Diversity is found to lead to conflict due to coordination difficulties (Kirton, 1976, 1989), which is a common cause for process conflicts (Jehn, 1997). Furthermore, the presence of process conflicts takes attention away from the team's task and can lead to a communication breakdown if the process related conflict dominates team interactions. As a consequence, process conflict is seen as damaging (Jehn 1997).

2.3 Communication and creativity

We will in this chapter outline how the linkage between communication tools and creativity is grounded in the literature, which gives support for the path between communication tools and creativity in figure 1-1.

Nemiro (2004) support the proposition by Daft & Lengel (1986) that richer mediums are better suited where a lot of non-standard information needs to be shared or discussed, common examples are: conflict resolution, brainstorming, strategic planning or other complex and creative tasks (Nemiro, 2004; Suh, 1999). Modern teamwork has also shown a growing tendency to include tasks that are more complex and demanding (Salas et al., 2008). Therefore, richer communication tools could provide a better fit as they more easily allow members to correct misinterpretations and provide additional information through verbal, as well as nonverbal channels to enhance understanding of the communicated message. Nonetheless, Curşeu et al., (2008) state that virtual teams require more time to reach decisions as team members are less aware of each other's knowledge and have a harder time anticipating other team members reactions. In addition, mediated communication makes it harder to build trust, warmth and attentiveness that help foster group cohesion (Jarvenpaa & Leidner, 1999; Jarvenpaa, Shaw, & Staples, 2004). However, other researchers have found that communication tools that allow for richer information exchange have shown to increase team cohesion, trust (Hinds & Bailey, 2003) and team commitment (Maznevski & Chudoba, 2000; Rico & Cohen, 2005), which are important for creativity in teams (Chang, Jia, Takeuchi & Cai 2014).

Sharing and integration of information between team members is better in teams that communicate with richer communication tools than the ones using leaner communication tools (Curşeu et al., 2008; Cramton, 2001). This is due to the increased information pool available to diverse virtual teams, and that by fostering information exchange through communication tools that convey more nonverbal and social cues, teams can increase their common information pool and more easily make inference about other team member's knowledge (Curşeu et al., 2008). This is supported by Cramton (2001), who points out that a lack in the immediacy of feedback inherent in leaner communication tools has been shown to reduce the amount of knowledge sharing and development of mutual knowledge in virtual teams. Nemiro (2004) supports this, arguing that for creative work it is key to have periodic face-to-face

meetings or to closely simulate face-to-face meetings in real time to accomplish creative output.

When it comes to generating ideas and conveying ambiguous messages, lean, asynchronous communication tools has generally been considered a poor fit for the task, since they allow for less for social presence (Sallnäs, 2005) and exclude richer information channels (Daft and Lengel, 1986; Nemiro, 2004). On the other hand, studies have found that using lean communication tools can reduce miscommunications due to accent, and give non-English native speakers more room to formulate themselves precisely and unambiguously (Shachaf, 2008; Klitmøller and Luring, 2013). However, the reduction or removal of social and nonverbal cues leaner tools imply can lead to communication breakdowns, as the tools does not provide enough nonverbal information to capture the intended message. The lack of a shared understanding and framework can lead teams to wrongly interpret the message and meaning team member's can convey, which can easily hamper the creative process and lead to conflicts. On the other hand, leaner communication tools are generally considered a better fit than richer tools when it comes to sharing of non-ambiguous and canonical information or knowledge (Daft and Lengel, 1986). Since using a rich tool for conveying canonical information might lead recipients to attach additional meaning that was not intended (Nemiro, 2004).

2.4 Communication and conflict

This chapter will outline how the linkage between communication tools and conflict is grounded in the literature, which gives support for the path between communication tools and conflict seen in figure 1-1. We will start the chapter off by introducing communication challenges caused by mediated communication and round the chapter off by describing conflicts in global virtual teams caused by communication challenges.

Communication is an essential player in the development of conflict and its management, and many conflicts are rooted in a communication misunderstanding or breakdown (Cramton, 2001; Putnam, 1988). Putnam (1988, p. 205) further elaborates that communication “shapes the formation of issues, the emotional climate of conflicts and the cyclical development of interaction”. Since communication is a key component in conflict, the presence of conflict also impact and shape communication patterns, which leads the relationship between communication and conflict to be reciprocal (Giddens, 1984).

The effects technology mediated communication enacts on interpersonal and group processes has been an ongoing topic of research. Researchers explain this by stating that interpersonal and group processes are negatively affected by mediated communication, since it reduces the connection between team members and reduces social presence (Short, Williams & Christie, 1976; Yoo & Alavi, 2001). The reduction in contextual, nonverbal and social cues caused by technology-mediated communication reduces the degree to which groups share interpersonal information and build relationships (Hinds & Bailey, 2003). Research also show that technology mediation reduces cohesion (Straus & McGrath, 1994), leads to lower group identity (Bouas and Arrow, 1995) and increases competitive behaviours (Purdy, Nye, & Balakrishnan, 2000). However, media richness theory proposes that richer media can dampen the negative effects of mediated communication (Daft & Lengel, 1987), since richer medias are more effective at facilitating shared meaning and can increase the social presence that is reduced by mediated communication (Yoo & Alavi, 2001). Markus (1994) also supports this. He found that after the introduction of an email system, users experienced that their interpersonal relationships were weakened. Others have also discovered that increased use of lean media tools can have a negative effect on global virtual teams as it increases conflicts (Kankanhalli, Tan & Wei, 2006).

Cramton (2001) identified some common types of communication problems that contribute to misunderstandings in virtual teams: The failure to communicate contextual information, uneven distribution of information, differences in salience of information to individuals and the interpretation of silence. She further concluded that the use of text-based communication increased the rate of attribution towards team members and thus increased interpersonal conflicts. In addition she points out that the lack of shared contextual knowledge about the situation of other team members led to frequent misunderstandings and thus could increase process conflicts. This is supported by other researchers who found that when familiarity between team members are low, and less information is shared about how and when team members work, process conflicts are more likely to arise (Deutsch, 1969; Goodman & Leyden 1991).

Communication tools that promote exclusion rather than inclusion highlight the problem of uneven distribution of information. Cramton (2001) found in her study of distributed teams that the reliance on email fostered greater exclusion as information was not sent to all members, either by accident or deliberately. This increased conflicts as team members assumed that everyone had received the same information. She further points out that this led to increased process and relationship conflicts as team members attributed the disagreements and misunderstandings to personal factors rather than technological factors, and disagreed over how to proceed and schedule the work. Hollingshead (1996) found that team members who used mediated communication were less likely to share uniquely held information due to team members finding it more difficult to ask others for the information they needed, and make inference about what knowledge different team members had. In addition, team members had more trouble interpreting the information that other team members were communicating, and attached different meaning to the information than what was intended. Cramton (2001) found supporting evidence for this, and posits that the choice of communication tool might impact the weight that various team members place in different pieces of information.

The propensity for different team members to attach different meaning to the same information, are conducive to team members having different viewpoints. The lack of shared context causes team members to have difficulties developing mutual understanding (Fussell & Krauss, 1992; Clark & Brennan 1991). Therefore, team members are more likely to develop different understandings of issues and task conflict is likely to follow (Jehn, Chadwick, &

Thatcher, 1997). A link between increased communication using lean tools and increased task and relationship conflict is found in a study conducted by Kankanhalli et al., (2006). This was mainly due to the volume of information being sent via email was too great for team members to absorb which led to misunderstandings. They also found that the lack of immediate feedback inherent in lean communication tools further exacerbated the misunderstandings, which increased the chance of the misunderstanding to devolve into a task conflict.

In sum, the research poses that teams who utilise mediated communication are more prone to conflict, but that the type of communication tool might mitigate some of the negative effects, as described by media richness theory (Daft & Lengel 1986). Uneven distribution of information leads team members to work based on different information, which has been shown to increase task conflicts when intragroup relationships are weak (Brehmer, 1976). Team members who have been excluded from parts of the team communication might call into question the team's methods, increasing the likelihood of process- and relational conflict (Cramton, 2001). In addition, mediated communication reduces the team's ability to communicate and discern contextual information about each other, which might also increase relationship conflicts (Hinds & Bailey, 2003).

2.5 Conflict and creativity

We will in this chapter outline how the linkage between conflict and creativity is grounded in the literature, which gives support for the path between conflict and creativity of our model (see figure 1-1). We therefore present how the three different types of conflicts described earlier have been shown to influence creativity in previous research.

The literature has established that diverse teams can experience conflict (Kirton 1976, 1989; Stahl, Maznevski, Voigt, & Jonsen, 2010). Carnevale and Probst (1998) conclude that conflict, or even anticipation of a conflict, changes individuals thought processes to become more narrow and rigid. As creativity flourishes in environments that are open and sharing, it is suggested that this limitation of thinking should hamper creativity (Kurtzberg & Amabile, 2001).

The literature proposes that both relationship conflict and task conflict are important factors for creativity in teams (Hu, Chen, Gu, Huang, & Liu, 2017; Lynch, O'Toole & Biemans, 2014; Kurtzberg & Amabile 2001). However, researchers have found various results on how team conflict impact creativity. While many researchers agree on relationship conflicts having a negative impact on creativity (Hu et al., 2017; Chen & Chang, 2005; He, Ding & Yang, 2014; Yong, Sauer, & Mannix, 2014; Kurtzberg & Amabile 2001), there are mixed findings regarding task conflicts impact on creativity. Some researchers argue that task conflict has a negative impact on creativity (He et al., 2014; Yong et al., 2014), while others argue task conflict increases team creativity (Lu, Zhou, & Leung, 2011; Hu et al., 2017; Chen & Chang, 2005). Jehn (1995) in turn, argues that a moderate amount of task conflict is positive, while larger amounts is counterproductive. Thus, more research is called for in the field of how task conflict impacts creativity.

However, conflicts are volatile and any type of conflict can escalate from a minor disagreement to an unmanageable conflict (Kurtzberg & Amabile, 2001). They argue that conflicts that escalate can easily change from being a productive task related conflict towards evolving into a destructive relationship conflict. Further research on the field, illustrates that there is a delicate balance between the two, demonstrating that if two people experience a task conflict, they may attribute the task related problem to each other's personality, resulting in

them liking each other less on a personal level (Jehn, 1995). This can in turn explain the various findings regarding creativity and task conflict.

On the other hand, there exist reasons for why task conflict can be beneficial for creativity. Research proves that total group agreement can be harmful due to “group think” where groups prioritise consensus over considering other alternatives (Janis, 1972). Others suggest that task conflict can produce more original work because multiple viewpoints are shared (Dyne & Saavedra, 1996) leading to more creative output. Additionally, other researchers found that groups experiencing task conflict leads to more divergent (Nemeth, 1986) and more complex (Gruenfeld, 1995) solutions than groups experiencing consensus. These characteristics all fit into Amabile’s (1996) definition of creativity.

Furthermore, the presence of process conflicts takes attention away from the team’s task and can lead to a communication breakdown if the process related conflicts dominate team interactions. In addition, the lack of communication and communication breakdowns has been found to reduce creativity (Nemiro, 2004). Therefore the presence of process conflict, may lead to communication breakdowns and hamper creativity by removing focus from the task at hand. As a consequence, process conflict is seen as damaging (Jehn, 1997) and negatively impacting creativity (Kurtzberg & Amabile, 2001).

2.6 Development of hypotheses

While earlier research on global virtual teams has focused on trust, performance, leadership and technology, there is limited research between the link of communication tools, conflict and creativity (Gilson et al., 2015.) In this chapter we will therefore develop and present the hypotheses we wish to test in this study.

2.6.1 Communication and creativity

The research on virtual teams have found that communication mediated through different online tools makes it more difficult for teams to anticipate other team members reactions (Curşeu et al., 2008), convey warmth (Jarvenpaa & Leidner, 1999), build trust and foster team cohesion (Jarvenpaa et al., 2004). However, media richness theory suggests that richer communication tools can mitigate some of the negative effects (Daft & Lengel 1986; Daft & Lengel, 1987). Researchers have also found that teams who use richer communication tools are better at sharing and integrating new information (Curşeu et al., 2008; Cramton, 2001). For tasks involving complex problem solving, conflict resolution and a high degree of ambiguity, richer communication tools are better suited (Daft & Lengel, 1986; Suh, 1999; Maznevski & Chudoba, 2000; Nemiro, 2004). Nemiro (2004) also suggest that periodic communication is essential when teams need to produce some form of creative output, since synchronous feedback and richer information is key when teams want to make decisions, share knowledge and leverage the unique expertise of different team members. The global virtual teams in our study are solving complex business cases. We therefore argue that teams who used richer communication tools more frequently will have an increased creative output than teams who relied more on leaner communication tools. Therefore we propose the following hypothesis:

***H1a:** Increased use of high richness communication tools, controlled for the use of low richness communication tools, are positively related to the creative output in global virtual teams.*

Lean communication tools are a poor fit for conveying and discussing ambiguous and complex information, and thus ill suited for tasks other than sharing of canonical information (Daft & Lengel 1986). The teams of this study need to discuss and make decisions from complex and

ambiguous information, and therefore the use of communication tools that offer delayed feedback and support fewer nonverbal communication channels will likely lead teams to exclude sharing of all task-relevant information and produce less creative outputs.

***H1b:** Increased use of low richness communication tools, controlled for the use of high richness communication tools, are negatively related to the creative output in global virtual teams.*

2.6.2 Communication and conflict

The interplay between communication and conflict is tightly intertwined, and conflicts are often rooted in a communication misunderstanding (Cramton, 2001; Putnam 1988). This poses a special relationship between communication and conflicts in global virtual teams, resulting in communication tools and conflict to highly influence each other. Furthermore, research points to the fact that teams that utilise mediated communication experience more conflict than co-located teams (Milliken & Martins, 1996; Hinds & Bailey, 2003; Hinds & Mortensen, 2005). Klitmøller and Luring (2013) support this, since mediated communication increases misunderstandings. Other research also point to the fact that heterogeneous teams are more prone to conflict than are homogenous teams (Kirton, 1976, 1989; Schahaf, 2008; Stahl et al., 2010). Hinds & Bailey (2003) posit that this reduction in social presence caused by mediated communication, reduces the degree to which virtual teams share interpersonal information and build relationships, which is crucial to developing a shared understanding. Other research has shown that technology mediated communication reduces group cohesion (Straus & McGrath, 1994) and group identity (Bouas & Arrow, 1995), while it increases competitive behaviours (Purdy et al., 2000). We therefore find it reasonable that increased communication in global virtual teams increases the amount of conflict found in these types of teams, and that this relationship is present for teams that communicate with high richness tools as well as low richness communication tools.

***H2a:** Increased use of high richness communication tools increases conflicts (task, relationship, process) in global virtual teams.*

***H2b:** Increased use of low richness communication tools increases conflicts (task, relationship, process) in global virtual teams.*

2.6.3 Conflict and creativity

Several researchers have established that there is a relationship between conflict and creativity (Kurtzberg & Amabile, 2001; Jehn 1995; Chen & Chang, 2005; Hu et al., 2017; Pelled et al., 1999; Bourgeois, 1985; James, 1995; Lynch et al., 2014), though there are differences in how the different types of conflicts impact creativity (Kurtzberg & Amabile, 2001). There is however broad agreement within the existing literature that relationship conflict has a negative impact on creativity in teams (Chen & Chang, 2005; Hu et al., 2017; Kurtzberg & Amabile, 2001). Relationship conflict is also common in highly diverse groups (Jehn et al., 1999), which is an important characteristic of global virtual teams. Therefore, we expect relationship conflict to be present in our study and that the existing findings on its impact on creativity to be valid within the context of global virtual teams. This leads us to the following hypothesis:

***H3a:** Relationship conflict is negatively related to creative output in global virtual teams.*

Diversity can be a factor that increases task conflict (Pelled et al., 1999), and task related conflicts can improve creativity (Bourgeois, 1985; Eisenhardt & Schoonhoven, 1990; James 1995; Chen & Chang, 2005; Hu et al., 2017). Other research illustrates that teams who prioritise consensus might consider less alternatives and be subjected to “group think” (Janis, 1972), which suggests that task conflict can be positive for including more alternatives and increase the creative process. This is supported by Dyne and Saavedra (1996) who propose that sharing multiple viewpoints increases creativity in teams. Additionally, there is evidence of task conflict producing work that is more original (Dyne & Saavedra, 1996), divergent (Nemeth, 1986) and complex (Gruenfeld, 1995). Based on empirical findings we argue that task conflict should increase creativity in global virtual teams as their diverse nature should suggest that they have a high number of various viewpoints, which help them produce higher quality creative output.

***H3b:** Task conflict is positively related to the creative output in global virtual teams.*

Diversity is found to lead to conflict due to coordination and communication difficulties (Kirton, 1976, 1989), which is a common cause for process conflicts (Jehn, 1997). With global virtual teams being spread across different time zones, we expect process conflict to be present, which in turn decreases creativity (Kurtzberg & Amabile, 2001). Nemiro (2004)

supports their argument, stating that lack of communication and communication breakdowns are factors that can lower creativity. Therefore, we expect the occurrence of process conflict in global virtual teams to lead to communication breakdowns that hamper creativity.

H3c: Process conflict is negatively related to the creative output in global virtual teams.

2.6.4 Mediation

Since we believe there exists a direct link between high and low richness communication tools and creativity, we propose that some of that relationship can be explained by the presence of conflict. Based on the research presented in the previous chapters we have established that global virtual teams are prone to experience conflicts (Hinds & Bailey 2003; Hinds & Mortensen, 2005; Cramton 2001; Goodman & Leyden 1991), which in turn impacts creativity (Kurtzberg & Amabile, 2001; Jehn 1995; Chen & Chang, 2005; Hu et al., 2017; Pelled et al., 1999; Bourgeois, 1985; James, 1995; Lynch et al., 2014).

In subchapter 2.6.1 we established that use of high richness communication tools are expected to increase creativity (H1a). At the same time, we reckon high richness communication tools to increase conflicts (H2a). Among the three different conflicts, we only expect task conflict to be positively related towards creativity (H3b). Therefore we predict the positive relationship between high richness communication tools and creativity to be partly explained by task conflict.

H4a: A positive relationship between high richness communication and creative output is mediated through task conflict.

On the other hand, we expect to find a negative relationship between low richness communication tools and creativity (H1b), as well as a positive relationship towards conflict (H2b). An empirical study has found that the increased use of low richness communication tools increases relationship conflict (Kankanhalli et al., 2006) and that relationship conflict is damaging in terms of creativity (Chen & Chang, 2005; Hu et al., 2017; Kurtzberg & Amabile, 2001) (H3a). Therefore, we expect that some of the negative relationship between low richness communication tools and creativity is mediated by relationship conflict. Hence the following hypothesis:

H4b: A negative relationship between low richness communication and creative output is mediated through relationship conflict.

2.7 Research model

With background in the theory and empirical research presented in this chapter, we develop seven hypotheses that seek to explain the relationship between communication tools, conflict and creativity. A summary of the research model and our hypotheses can be found in figure 2-1 and table 2-2 below.

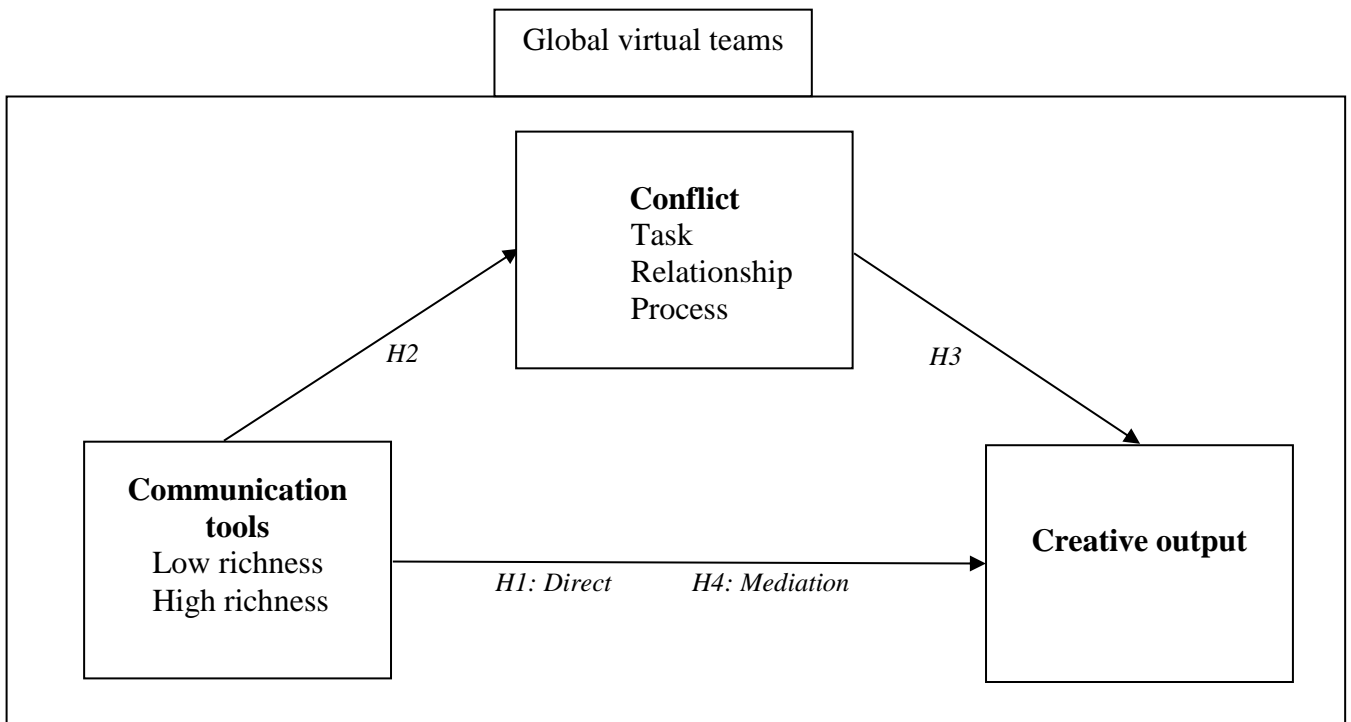

Figure 2-1: Research model with hypotheses

Table 2-2: Summary of hypotheses

Hypotheses	
H1a	<i>Increased use of high richness communication tools, controlled for the use of low richness communication tools, are positively related to the creative output in global virtual teams.</i>
H1b	<i>Increased use of low richness communication tools, controlled for the use of high richness communication tools, are negatively related to the creative output in global virtual teams.</i>
H2a	<i>Increased use of high richness communication tools increases conflicts (task, relationship, process) in global virtual teams.</i>
H2b	<i>Increased use of low richness communication tools increases conflicts (task, relationship, process) in global virtual teams.</i>
H3a	<i>Relationship conflict is negatively related to creative output in global virtual teams.</i>
H3b	<i>Task conflict is positively related to the creative output in global virtual teams.</i>
H3c	<i>Process conflict is negatively related to the creative output in global virtual teams.</i>
H4a	<i>A positive relationship between high richness communication and creative output is mediated through task conflict.</i>
H4b	<i>A negative relationship between low richness communication and creative output is mediated through relationship conflict.</i>

Table 2-2: Summary of hypotheses

3. Method

In this chapter we will give a description of our research method. First, we will present this study's design, approach and give an overview of the X - Culture project before we delve into data collection and description of our variables. We round off this chapter by discussing validity as well as reliability.

3.1 Research design

Research design refers to the overall strategy chosen to integrate the components of this study in a coherent and logical way, where the research problem is related to relevant empirical research in an effective manner (Ghauri & Grønhaug, 2010). The research design is thus a framework for collecting data and analysing it in a consistent and structured manner. In this chapter will elaborate the research design that underlies the study we have conducted.

This study uses a of descriptive research design, which is often used in quantitative studies where questionnaires has been provided in order to obtain data (Saunders, Lewis & Thornhill, 2009). The dataset used in this study have mainly collected data with the use of questionnaires. The goal of this study is to describe and investigate if the frequency and richness of different communication tools relate to the creativity in global virtual teams. Therefore, we find the study to qualify with the characteristics of descriptive studies, which are typically recognized by structured and clear problems that are easy to understand (Ghauri & Grønhaug, 2010).

3.1.1 Research approach

Deductive research is characterised by framing a hypothesis based on previously established theoretical constructs and then subsequently examine whether empirical observations provide substantial evidence in support of said hypotheses (Saunders et al., 2009). To examine the theoretically derived hypotheses presented in chapter 2.6 we use a quantitative analysis based on data collected by the X - Culture project in 2017.

During the spring semester of 2017, International Business students from 129 Business Schools and Universities spread over multiple continents all participated in a project where groups of students worked together to solve a real-life business case. Questionnaires were

administered before, during and after the project to gauge the team members' experiences with regard to communication, conflict and creativity. Additional data points were gathered from professors' rating of the participating groups deliverables.

3.1.2 X-Culture

X - Culture was founded in 2010 by Vasyl Taras, a professor at the University of North Carolina, who teaches International Business. The information in this paragraph is based on the X - Culture website (X - Culture, n.d., "For Professionals"). The program is designed for bachelor and master students, where professors who teach International Business courses all over the world can include the program in their course. Students enrolled in the course will then be entered in the X - Culture program where they will be put in student teams of 3 - 8 students from different countries to solve a real life business challenge made by one of the participating companies. Since the launch in 2010 a total of 41 200 students have completed the program from 271 different universities. Each X - Culture program has a timeline of 10 weeks and there are two sessions conducted each semester in order to accommodate for universities having different schedules. On average, there are 5000 students participating in each session ranging over 75 nationalities. As a result, X - Culture collect rich multi - source longitudinal data which is used for studying global virtual teams, international collaboration, experiential learning and related topics (X - Culture, n.d., "For Professionals").

Goal:

X – Culture's main goal is to enhance multicultural collaboration and provide students with relevant international work experience. Additionally, the program strives to provide value for students, the business community as well as collecting data for research purposes. The program aspires to bring the research, business and student communities closer together.

Students:

The information about the students in these paragraphs is based on the X - Culture website (X - Culture, n.d., "For Students"). Once students are successfully enrolled in the program, they receive X - Culture training materials and program instructions. All X - Culture materials are provided in English. In order to secure that students have read and understood the materials, they have to successfully pass the X - Culture readiness test before participating in the project. Once the test is passed, the students will be allocated into global virtual teams, all from

different countries and universities. Each student team will receive a business challenge provided by an international company, for which they will have 10 weeks to solve.

During the project timeline, the students have weekly project deadlines that they have to complete. Additionally, each student will receive a personal email three days before each deadline with a link to an online progress update survey. The students have to answer the survey and report if the team has completed their weekly tasks. The students also receive weekly feedback as well as suggestions and updates on their team's progress compared to other teams.

At the end of the project, each team has to deliver a team report where they present their business challenge. 3 - 8 professors thereafter evaluate the reports. The number of professors is usually the same as the amount of participants on the team. The highest scoring teams will be awarded the X - Culture Best Team Awards. Additionally, individual students can be granted the season's best student award which will be evaluated by their individual performance records and peer evaluations.

X - Culture emphasises that the project is not a test, rather an exercise to learn and obtain more experience. The project aims to provide students with international work experience where they experience a real life consultancy project. At the end of each project the students will be invited to attend the X - Culture Symposium, where students can meet other X - Culture participants and professionals to exchange ideas and expand their network. Additionally, all X - Culture participants who successfully complete the project receive X - Cultures Certificate for Global Collaboration Experience (X - Culture, n.d., "For Students").

Instructors:

The information about the instructors in these paragraphs is based on the X-Culture website (X - Culture, n.d., "For instructors"). Instructors are defined as professors who participate in the X - Culture program as part of their International Business course. Professors who are successfully enrolled in X - Culture will receive all X - Culture materials including instructions and guidelines for students and instructors, training materials and other information. The material includes the task the teams will be working on, deadlines, available communication tools and other project related materials. Professors also need to successfully pass the X -

Culture readiness test. While students receive weekly aggregated performance updates, professors receive detailed weekly reports including performance measures of each of their students.

During the project, the professors receive multi-source data on their students' performance. These data include performance on the pre - project readiness test, ability to meet weekly deadlines, weekly summaries, detailed post - project peer evaluations and multi dimensional evaluation of the quality of the team reports. Participating professors also have the opportunity to research the data and get involved as co - authors of the resulting scholarly publications.

X - Culture manages the coordination, communication and performance monitoring of students. Professors however, provide their students with regular mentoring and guidance. According to X – Culture, each professor devotes a few minutes from each lecture to discuss students progress and address project challenges. At the end of the project, all student teams submit their project through an online platform that checks for plagiarism. Additionally, the students must complete an online post - project survey that includes peer evaluations.

The professors grade the team reports by using standardized rubrics. The professors evaluate their own students, meaning they will usually grade as many projects as the number of participating students they enrol, as every student is assigned to a different team. In other words, for a team consisting of 6 students, 6 different professors will be evaluating the project, all from the respective universities of the students. The professor evaluations of the teams' reports are aggregated, and used for selecting the best student teams. Additionally, each professor receives an X - Culture Global Educators Certificate once his or her students successfully complete the project (X - Culture, n.d., "For instructors").

3.1.3 Participants

The study sample was collected in the first semester of 2017, and was truly global with more than 129 universities participating from a total of 42 different countries. This resulted in a total of 770 teams with the average size of 5,3 students per team. In Table 3-1 we offer descriptive statistics for all the participating students and universities. As shown from the table below, there were a total of 4053 students who participated in the study with a total of 49,0 percent of the sample being females and 8,7 percent of respondents omitting to disclose their sexual

identification. The remaining 42,3 percent were males. The average age of participants was 22,8 years. The sample was very diverse with students' country of birth spread over 133 countries.

	N	Average(SD)	Percent
Participants	4053		100,00
Female	1984		48,95
Male	1717		42,36
Missing	353		8,71
Age		22.8 (3.78)	
Countries of Birth	133		
Universities	129		
in Countries	42		
Teams	770	5.33 (0.72)	

Table 3-1: Descriptive statistics

Figure 3-1 on the next page gives an overview of the different regions that the participating students are studying in. Several universities could participate from the same country and there were no limits towards how many students a university could enrol in the program. We extracted that the country with the highest amount of participating schools was the United States with a total of 44 schools. The remaining countries had an average participation rate of 1,9 universities. For more detailed information about the number of participants and schools in each country, see table 3-3 in the appendix.

As seen in figure 3-1, the largest groups of students are from North America (35,3 %), followed by South America (22,2 %) and Asia (19,8 %). In total, the students were distributed among many regions stretching from Africa, Asia, Middle East, the Americas and Europe, making the sample truly diverse.

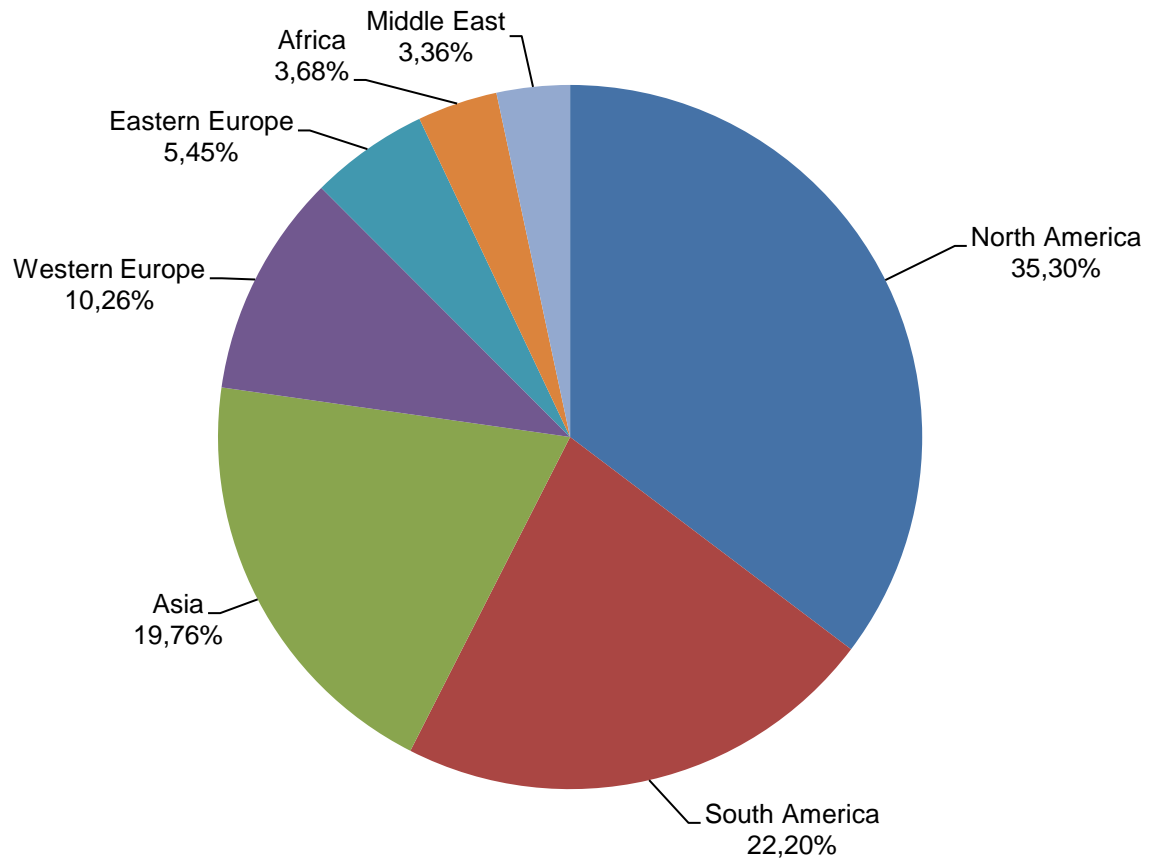

Figure 3-1: Graph of participants by country

3.1.4 Project timeline

The duration of the project went over the whole semester and the active teamwork phase lasted approximately ten weeks, where the team members communicated at least once a week. The participants had to answer surveys before, during and after the project. Below is an illustration of when the variables relevant for this study were collected. As shown below, the conflict variables were collected in weeks three through nine, while all the communication variables were collected at the end of the project in week ten. After the students handed in the reports, the professors graded the project, were creativity was one of the grading criteria.

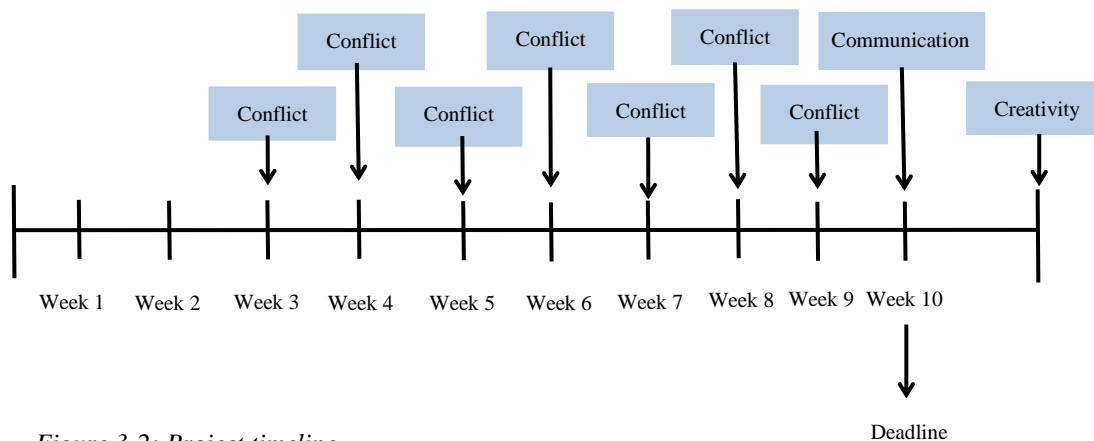

Figure 3-2: Project timeline

3.2 Data collection

3.2.1 Dependent variable

In order to look at the variance in richness of how different communication tools relate to creativity, we need to establish some measurement for creativity as our dependant variable. However, measuring creativity has shown to be a challenging task, and 50 years of research on the field of creativity has yet not resulted in a framework measuring creativity neither on individual nor team level (Leenders, Van Engelen & Kratzer, 2003). Despite the lack of a generally agreed upon framework there are methods we can use to gauge creativity. Amabile (1996) propose that creativity is something that individuals can recognise. Additionally, she argues that experts in certain fields have the ability to judge if something or someone is creative or less creative in the domain of their expertise. In our dataset we consider the professors in International Business as experts on the field and argue that their rating on creativity is a qualified measure. The professors ratings are measured on a seven item likert scale with equal distance, where 1 represents “poor” and 7 represents “excellent”. The rating was given after the teams had finished and handed in their reports. In addition, each paper had the same amount of graders as students, which makes the measure quite robust and objective.

As an additional measure of creativity, the students were asked during the end of the project period to rate how innovative they thought their team’s proposal were on a 5 item likert scale, where 1 represented “*Very poor*” and 5 represented “*Very good*”. The question read as follows: “*How would you rate the proposal submitted by your team in terms of the*

following?...Innovation (how innovative-original was the idea)?". This measure is considered as the teams own subjective evaluation as to their creative output. We will use the professors rating in the main analyses in chapter 4.3, but we will conduct an additional analysis using the teams' subjective evaluation as a dependent variable in chapter 4.4.

3.2.2 Independent variables

The independent variables in our study are measures of communication frequency over the project period. We create two different independent variables based on the two categories of communication tools we presented in subchapter 2.2.2. We created the categories by averaging a team's response of frequency of use on all communication tools used within a category. All of the questions pertaining to the use of communication mediums had the same framing and used the same item scale.

The frequency and use of the communication tools was measured at the end of the project (week 10) and is a measure of how frequent the members of the group communicated with each other. The surveys consisted of a six-item scale ranging from 1 - 6, for each of the communication tools, Email, Slack, Whatsapp, Viber, Facebook, Skype, Facetime, Google hangouts and telephone. For each tool they were asked: "*How many times over the course of the project would you say you used the following means of communication?*"...Slack, Whatsapp, Skype, phone etc. Each communication tool had its own question, and the participants had the following answers to choose from: (1) *Never*, (2) *Once per month*, (3) *2-3 times per month*, (4) *Once per week*, (5) *2 - 3 times per week*, (6) *Every day*.

Low richness Communication

The low category consists of communication tools that offer poor media richness and therefore is used for written communication. The low category consists of an aggregation of the following independent variables: (1) *Slack*, (2) *Whatsapp*, (3) *Facebook*, (4) *Viber*, (5) *Email*.

High richness communication

The high category consists of communication tools that offer rich communication where both verbal and nonverbal cues can more easily be transmitted. Video and audio conferences as well as telephone communication are the communication tools that can offer the possibility of

transforming these cues. The high category consists of an aggregation of the following independent variables: (1) *Skype*, (2) *Google - Hangouts* (3) *Facetime* and (4) *Telephone*.

3.2.3 Process variables

During every week of the project all participants were asked a series of questions pertaining to their project work, and individual attributes, administered at the end of the week. The weekly questionnaires contained from 15 to 40 questions, with three weekly questions relating to the perceived level of conflict for the previous week. The conflict related questions were based on three categories; relational, task and process conflict. All three questions contained 7 items, where the response alternatives to how many conflicts a team had experienced during the previous week where: (1) *No conflicts at all*, (2) *One*, (3) *Two*, (4) *Three*, (5) *four*, (6) *Five*, (7) *Six or more*. The question relating to interpersonal conflict read: “*How many conflicts, arguments, or unpleasant situations have you experienced last week?(Interpersonal conflicts (personal, emotional, name calling))*”. For task conflict the question asked was: *How many conflicts, arguments, or unpleasant situations have you experienced last week?(Task arguments (business decision, answer to challenge questions))*”. And finally for process conflict: *How many conflicts, arguments, or unpleasant situations have you experienced last week?(Process conflict (scheduling, workload distribution, team member roles))*. In order to create our three process categories we have aggregated each individual response to the team level, and mean-averaged each team’s score from week three to nine into one overall score. The overall score reflects a team’s average level of task-, relationship- and process conflicts per week over the project period.

3.3 Data analysis

This study relies on data analysis executed using IBM SPSS statistics 25. In this section we will describe some of our background analyses, how we proceeded with aggregation of variables and which statistical methods we employed.

3.3.1 Preparing data

A team is defined by a group of two or more participants. Therefore we conducted an analysis of how many of our teams had less than two team members, meaning they would not fit the

scope of this study. 102 teams were removed due to there only being one person in the team. Furthermore, we measured the ratio of missing values per team for our communication and conflict measures, and subsequently removed teams who had more than 40 % missing values over the communication and conflict variables, in accordance with Jong, Schalk and Curşeu (2008). The reason for the 40 % cutoff point is that the average team consists of 5,3 members, and if more than two of the members categorically failed to reply to the surveys the team would have 40 % missing values. Therefore, by setting the cutoff at 40 % we aim to reduce the influence of teams whom's scores might not reflect the team's opinion due to lack of respondents. An additional 19 teams were removed after adjusting for missing values; the remaining 770 teams are included in our analyses.

3.3.2 Aggregation

The dataset provided in this study is based on individual level data and team level data. In order to analyse the teams, the individual level data has been aggregated to team level data for the purpose of this analysis. The hypotheses presented in chapter 2.6 are based on the mean-aggregated variables of the communication tools and conflict variables, and these variables provide the foundation for our results in chapter 4.

If the team-aggregated measure is to be valid, it is important that the team-aggregated results represent the teams' response and not the average response of the individuals located on the same team. This is important, since we cannot assume that the average score of the team members represents the team's opinion, since the responses are based on each individual's perception, which might vary between group members. A common way to test for agreement amongst team members to justify aggregation has been to employ the Rwg index together with ICC(1) and ICC(2) scores (Woehr, Loignon, Schmidt, Loughry, & Ohland, 2015). Rwg indicates whether group members agree, and thus is a commonly used measurement to infer that the aggregate of team members' scores may constitute the team's score. In addition to demonstrating that our measurements showcase within-group agreement, we also show that the measures are consistent among raters, which is done via the ICC(1) and ICC(2) measures (Bliese, 1998). ICC(1) measures how much of the variable's variance is attributable to belonging to a team, and also indicates to what degree the score of a team member can be

attributed to belonging to the team (Bliese, 1998). ICC(2) provides an estimate of the reliability of the teams' group mean within a sample (Woehr et al., 2015). ICC scores represent measures of effect size (Woehr et al., 2015), therefore ICC(1) scores over 0.25 has traditionally been used to signify a strong effect (LeBreton & Senter, 2008). LeBreton and Senter (2008) also suggest that ICC(2) values above 0.70 is adequate.

When we talk about inter-rater agreement (Rwg), scores of 0.70 or higher is considered as a generally acceptable value to justify aggregation (Biemann, Cole, & Voelpel, 2012), meaning there is enough agreement among the members in the team. However, Biemann et al. (2012) argues that instead of drawing a threshold of 0.70 researchers should nuance the results of the Rwg scores in the following categories: .00 to 0.30 lack of agreement, 0.31 to 0.50 weak agreement, 0.51 to 0.70 moderate agreement, 0.71 to 0.90 strong agreement and 0.90 to 1.00 very strong agreement.

Table 3-2 Rwg and ICC scores

	Rwg	ICC(1)	ICC(2)
Interpersonal conflict	0,94	0,29	0,67
Process conflict	0,86	0,26	0,66
Task conflict	0,88	0,25	0,64
Low richness com.	0,85	0,32	0,72
High richness com.	0,86	0,29	0,68

N = 770

Table 3-2: rwg and ICC scores

As the rwg – scores indicate in table 3-2 above, there is evidence of strong within team agreement for the variables pertaining to conflict, low and high richness communication tools, which all received a score over 0.80. Our Rwg scores support aggregation of the selected individual level variables to team level variables. The ICC(1) values above show that all of our aggregated constructs are at or above the 0.25 threshold, indicating strong effects (LeBreton & Senter, 2008). This is however not the case for the ICC(2) scores, where all but the low richness communication tools group show an ICC(2) score slightly below 0.70. However they are all fairly close to the recommended acceptance limit, and we chose to move forward with the aggregation since the ICC(1) scores are adequate and the Rwg scores measuring intra team agreement is also very strong. We could not measure the Rwg or ICC

scores for the creative outputs of the teams as we received these scores pre-aggregated from X – culture.

3.3.3 Multiple regression

Regression is a statistical tool that helps explain the relationship between one or more independent variables on a dependant variable (Field, 2009). When we include more than one independent variable in a regression, we perform a multiple regression. The advantage of utilising a multiple regression is that we can control for multiple factors that might impact the results of the analysis. We employ multiple regressions when testing the different hypotheses connected to the paths outlined in figure 2-1. When performing the analysis for one of the communication variables, we need to include the other communication variable as a control, since the teams does not use a group of communication tools in isolation. By including the other communication variable in our regressions, we control for its effect on the creative outcome (Field, 2009).

3.3.4 Mediation analysis

Mediation is a method used to describe the relationship between an independent and dependent variable, through a third variable (Hayes, 2013). To implement this model, we have used Preachers and Hayes process tool in SPSS to test whether the effect of varying richness in online communication tools on creativity is mediated through the level of conflict. To test for this we use Preacher and Hayes model 4, see appendix 3-1. This model tests whether an independent variable affects a dependant variable through variation in one or more mediators, while also calculating the direct effect of the independent variable on the dependant variable (Hayes, 2013). By running multiple regressions over a set of models, where we bootstrap the samples to increase accuracy, the effects are generated alongside 95 % confidence intervals, which can indicate a significant relationship. By bootstrapping our samples, we resample to generate new data points based on our samples distribution to further assert that the true value of our coefficients is located within the confidence interval. If the model's bootstrapped confidence intervals exclude 0 as a value in the interval for the different coefficients we can infer a statistical significance. This means that we can with 95 % certainty assert that the estimated effect is different from 0, and that there exists a relationship between the variables.

3.4 Research quality

In this part we will discuss choices that we have made when constructing the method and how this impacts the study's validity and create limitations. Collection of the data this study relies upon has been a collaborative effort by the X-culture team and professors at the participating institutions. Therefore, the information and reasoning in this section is based on the information provided to us by the X-culture team about how they conducted the study and gathered the data.

3.4.1 Validity

The concept of validity relates to whether an instrument actually measures what it is designed to measure (Field, 2009). We can divide the concept of validity into three main categories; internal validity, construct validity and external validity (Saunders et al., 2009). In the subchapters below we will elaborate on internal-, construct- and external validity of our model.

Internal validity

Internal validity refers to the extent we can assert that a variable is causally related to the performed interventions, and not biased by other factors (Saunders et al., 2009). While correlation between one or more variables might occur, it is important to be aware that this does not necessarily mean that they prove a casual relationship (Field, 2009). One of the reasons for this phenomenon is that the correlation or regression coefficients does not state whether the relationship is affected by other factors that are not controlled for or included in our analysis. Internal validity is thus concerned whether the effect can be attributed to the existing input variables or whether there may be other factors that could explain the effect (Field, 2009). Such factors may be represented by individual factors such as nationality, age, motivation, cognitive abilities and intelligence or other team factors such as team processes, engagement or team collaboration. In sum, we recognise that there might exist other confounding factors that can affect the relationship between cause and effect, which we have not considered in this study. However, the aim of this study is not to create a complete model

of all possible variables that describe creativity in global virtual teams but rather a subset, namely conflict and communication richness and frequency.

Construct validity

Construct validity refers to whether our measurements actually measure the constructs that we intend to measure (Saunders et al., 2009). When using questionnaires, researchers often ask a series of questions that aim to measure something other than what is explicitly asked, in an attempt ensure to that the measured items are actually measuring the intended construct (Bagozzi & Phillips, 1991). In our study, the students are asked questions pertaining to their recollection of the occurrence of conflict and their communication habits. Since our constructs mostly rely on single items to gauge their presence, it poses a potential weakness to our study's construct validity. However, multiple studies have been done that showcase the validity of single-item measures in a series of circumstances (Robins, Hendin, & Trzesniewski, 2001; Nagy, 2002; Fuchs & Diamantopoulos, 2009). This is especially so if the measured construct is of a concrete rather than abstract nature. The reasoning being that abstract constructs are subject to a high degree of subjective interpretation, while concrete constructs are more often consistently perceived by different raters.

Our measures on communication frequency relies on self-reporting, it is therefore possible that different group-members recall differently when asked about how frequently they communicated with other team members. This poses a potential threat to whether our communication measurement actually captures the intended measure. However, the fact that the usage of each communication tool is measured using a single-item measure does not pose a significant threat to our construct validity. The framing of the communication questions asks raters to recall the frequency of which they used specific communication tools - a question that arguably has little room for subjective interpretations as to what constitutes usage of a communication tool (Fuchs & Diamantopoulos, 2009).

Questions aimed at gauging the frequency of conflict are not weakened by differences in recollection amongst team-members since the data is gathered on a weekly basis, opposed to the end of the project period. However, with a culturally heterogeneous sample, the perception

of what constitutes a conflict and whether participants will admit to there being a conflict can differ between cultures (Ting-Toomey, 1982). This is a weakness relating to our measure of conflict frequency. Since the measurement of the conflict-constructs rely on single items to gauge their presence, this poses another weakness to our study's construct validity.

External validity

External validity refers to whether the results based on one group are transferable to other relevant groups or a larger population (Saunders et al., 2009). To assert that our study has some external validity, we need to be able to argue why the results based on our sample is generalisable.

When we examine the effects of communication tools and their richness on creativity, we argue that a student sample can be considered appropriate since the sample is likely representative of the larger population when it comes to creativity and use of communication tools. Typically student samples are composed of young inexperienced people and the study relies on short in-classroom experiments that yield a small part of overall course credit, and bear little resemblance to workplace settings. However, our student sample was working on a real life business challenge with companies who have structured the case to resemble a real consultancy project. Additionally, the students have been working closely with company representatives during the project timeline, making the project resemble a real life business consultancy.

As a last remark, the study consisted of mainly master students, many with significant work experience, while other participants were bachelor students with at least some work experience. Master students represented more than half of the participants, while the remaining were bachelor students. The student projects consisted of somewhere between 20 to 50 % of overall course score, meaning that the grading of the project was significant for the student's overall performance in the course. Considering these factors we therefore argue that the student sample is generalisable for project based organisational teams, as the student sample had valid reason for been highly involved with the project. X - Culture also ensures the project involvement and continuity of students by posing mandatory weekly project deadlines. Lastly,

there is reason to argue the sample holds external validity as it is a fairly large sample (Saunders et al., 2009) and is heterogeneous by representing over 100 nationalities and having an equal gender distribution.

3.4.2 Reliability

Reliability refers to whether the data collection techniques and analyses yield consistent results (Easterby-Smith, Lyles, & Tsang, 2008, p. 109). A study is said to have good reliability if the data was collected at different times or from different observers, and still yielded the same results (Saunders et al., 2009). Another important factor in order to ensure reliability is that there is transparency in how the gathered data material is treated. There are multiple threats to reliability. In general we can divide these into participants error and biases, and observer errors and biases (Saunders et al., 2009). When it comes to the impact of biases and errors we had little impact on how to mitigate this, due to the fact that the X-culture team has conducted all data gathering. However, since the communication measures used in this study asked participants to recall how often they had used specific communication tools, participants might be affected by different biases when recalling the frequencies of communication. This challenge is present to a lesser extent when the measures for conflict were gathered, since they happened on a weekly basis.

On the other hand, participants might be less inclined to honestly recall the actual conflict levels within the team in fear of the answers affecting their overall grade. Furthermore, cultural differences might play a part in how different team members define conflict and therefore different team members might label a situation differently in terms of whether they perceived a conflict or what type of conflict they perceived (Ting-Toomey, 1982). In addition, since most of our constructs are measured by a single question there is a possibility that the participants misinterpret the questions and we unfortunately have little room to control for this occurrence. When it comes to observer biases and errors, this is arguable less relevant, due to the survey's being administered digitally and centrally by X - Culture. Additionally, all participants are given the same questions, formulated in the exact same manner, which is a way to reduce the impact of observer biases and errors (Saunders et al., 2009).

3.4.3 Approval and anonymity

In order to receive data from X - Culture, we sent an application outlining the study we wanted to conduct. After a meeting with Vasyl Taras, the founder of X - Culture, the research was approved and the requested data was received for the purpose of conducting this study. The received data is anonymous and does not provide any sensitive data that can identify the individuals who participated in the study.

4. Results

In this chapter we first conduct background analyses of our data to make sure it complies with the assumptions of multiple regression and mediation analyses. We thereafter present descriptive statistics for our variables and a correlation matrix. Lastly, we will delve into the regression results and mediation analysis and round off this chapter by recapping our findings and how they relate to the hypotheses developed in chapter 2.6.

4.1 Conditions for multiple regression and mediation analysis

As multiple regression makes a series of assumptions, we need to test whether our data meets those assumptions in order to make generalisations from it. Therefore, before we ran our regression analyses we checked if our data was influenced by the presence of missing values, outliers, normally distributed errors, linearity, multicollinearity, homoscedasticity and autocorrelation (Gelman & Hill, 2007).

4.1.1 Missing values

Our sample consists of 770 teams, and can be considered quite large. Other studies of teams and creativity have relied on substantially smaller sample sizes (Leenders, 2003; Letaief, Favier, & Le Coat, 2006; Dekker, Rutte, & Van den Berg, 2008). Barlett, Kotrlik, & Higgins (2001) propose a ratio of 10 observations for each independent variable included in an analyses, our sample of over 770 teams is therefore well above that ratio. We therefore remain confident that our sample size more than adequate. Following the aggregation of our independent and process variables, we looked at the amount of missing observations among the aggregated variables. All our conflict variables had 36 missing variables out of 770, which is just under 5 %. To determine whether our missing data is missing randomly we employed the Little's test (Little, 1988). We found that our missing observations were not missing at random, with a p-value of 0.048. We have therefore chosen to recode them with their respective means, which is the preferred action when handling data that is not missing at random and when the proportion of missing values is small (Tabachnick & Fidell, 2007).

4.1.2 Outliers

We have also checked our independent, process and output variables for outliers. Tabachnick & Fidel (2007) discuss different methods for handling outliers and they argue that removing or changing the score of the outliers is not a good approach when the outliers are univariate and can reasonably be part of the intended population from which the sample arise. While many of our variables contain some outliers, they are of a univariate type, and are likely believed to be part of the sampled population. By looking at table 4-1 in chapter 4.2 we see that interpersonal conflict has a mean of 1.272 while the maximum reported value is 3.81. While 3.81 is an outlier value, it is not unthinkable that this team has had an average of 2 to 3 conflicts of an interpersonal nature per week. The other outliers in our dataset also seem reasonable upon closer inspection. We have therefore chosen not to remove outliers, as we believe the outliers to be valid data points and representative of the population. Osborne and Overbay (2004) encourage researchers to use intuition and reasoning when considering outliers, and in this case we believe it is reasonable to keep the outliers as they represent the teams perception of conflict.

4.1.3 Normal distributers errors and linearity

We tested for normal distributed errors by looking at the values for skewness and kurtosis. Field (2009) suggests the limits +/- 1 for skewness and +/- 3 for kurtosis as acceptable limits. From table 4-12 in appendix 4-1 we find that our conflict variables marginally exceed the limit for skewness, and the variable for interpersonal conflict exceed the limit for kurtosis. However this is not a significant problem as Tabachnick & Fidel (2007) note that if the variables are skewed approximately the same amount, few improvements will be made to our analyses if we transform those variables. In addition, research suggest that only severe violations of the normality assumptions reduce the validity of statistical inferences from a regression analysis, this is especially so for large sample's (Havlicek & Peterson, 1977; Hayes, 1996). Hayes (2013) also notes that perfectly normal distributions are rarely encountered due to measurement procedures often used in research, for example when a variable represents a count of instances. We also check if linearity between the dependent and independent variables is present by examining the charts in appendix 4-1 (table 4-16 to 4-19). From a strict

perspective we see that a few of the relationships might have elements of non-linearity, however the data don't exhibit major violations of the linearity assumption.

4.1.4 Multicollinearity

Our model has two predictors, therefore it is important that those independent variables do not have a strong linear relationship between themselves. This is often termed multicollinearity, and we check for it by looking at the correlation between the independent variables and also by calculating the variance inflation factors (VIF) and acceptance-values. If the correlation between two of our independent variables don't exceed 0.7, we have an indication that our independent variables don't exhibit multicollinearity (Pallant, 2013). We can rule out the possibility of multicollinearity, if our VIF values are below 10 (Bowerman & O'Connell, 1990) and their tolerance levels are above 0,1 (Pallant, 2013; Field, 2009).

From our correlation matrix in table 4-2, only the correlation between process conflict and task conflict exhibit a correlation above 0.7. However a relatively high correlation between variables of similar type is to be expected. Our independent variables show a correlation of 0.3, which gives us confidence that we do not suffer from multicollinearity. The variance inflation factors and acceptance-values is considered a better measure of multicollinearity than correlations alone, and in table 4-13 in appendix 4-1 we see that for all our independent and process variables demonstrate VIF values well below 10, with acceptance-values above 0.1. We therefore conclude that we do not have multicollinearity in our dataset.

4.1.5 Homoscedasticity

To test whether our dataset is homoscedastic we have conducted the Breusch-Pagan test. We have homoscedasticity if the variance of the residual is constant for all levels of the independent variable (White, 1980). From table 4-14 in appendix 4-1 we see that our dependant variable and process variables excluding process conflict, demonstrate heteroscedastic errors. When the condition of homoscedasticity is not met, it will affect the validity of inference through effects on the standard error of the regression coefficients (Hayes, 2013). To remedy the effects of heteroscedasticity we employ a multiple regression macro developed by Hayes and Cai (2007), which employ heteroscedastic-consistent errors to increase the accuracy of our t and p value inference tests. Preacher and Hayes mediation tool

also offer heteroscedastic-consistent errors, therefore we are comfortable with proceeding with the analyses.

4.1.6 Autocorrelation

For any two observations the residuals should be independent of each other, if this holds we do not have autocorrelation (Field, 2009). We test this assumption with the Durbin-Watson test. The test-value for the Durbin-Watson test will be in the range of 0 - 4, where around 2 signifies no autocorrelation. From our tests we found that our Durbin-Watson value for the creative outcome variable is around 0.4, which signifies a positive autocorrelation. The other variables are centred around 2, which indicates no autocorrelation. The fact that we have positive autocorrelation suggests that there might be other variables that should be included. We agree that communication frequency alone is not the sole cause of creative output and therefore other omitted variables might influence the relationship. On the other hand the aim of this study is to ascertain what relationship the use and frequency of communication tools share with the creative output of groups, and is thus not aimed at being an all-encompassing model for the causes of creativity in teams.

4.2 Descriptive statistics

In the descriptive table below, we present an overview of the minimum, maximum, mean value and standard deviation for our independent variables, process variables as well as our dependent variable used in the hypothesis testing presented later in this chapter.

Table 4-1: Descriptive Statistics - variables

	Min.	Max	Mean	Std. Dev
Creative output	1,00	7,00	4,91	0,86
Low richness com.	1,28	3,20	2,31	0,27
High richness com.	1,00	3,00	1,47	0,36
Interpersonal conflict	1,00	3,81	1,27	0,29
Task conflict	1,00	3,88	1,64	0,42
Process conflict	1,00	4,69	1,83	0,50

N = 770

Creative output and conflict variables: measured on a 7 item scale

Table 4-1: Descriptive statistics - variables

We have 770 observations for all our variables as seen from table 4-1 above. The mean score is the average of all the teams' score on how often they used rich and lean communication tools, as well as how many relationship-, task- and process conflicts they experienced on a weekly basis. For example, the mean score of low richness communication (2,31) implies that team members communicated approximately one and a half time per month with each of the five communication tools, which the category consists of. This implies that the teams on average communicated between seven and eight times per month using low richness communication tools. The mean of high richness communication (1,47) implies that teams on average communicated two times a month using high richness communication tools. The mean score of the creative output is the average score the professors graded, based on the teams final product. Furthermore we note that the mean score and standard deviation for the creative output is quite high (Mean = 4.91, Std. Dev = 0.86), while the conflict variables means were all relatively close to the minimum value of 1. This indicates that the teams usually experienced few conflicts on a weekly basis. Also, we see that none of the values in our dataset exceeds the limits imposed by the measurement scales, which shows that we do not have any major errors in the data. We also checked for values exceeding the scale limits before we aggregated, with the same conclusion.

The correlation matrix gives a quick view of how our different variables correlate, and can thus be used as an indication for if there is any support for our hypotheses. The coefficients represented in table 4-2 below indicate to what extent two variables correlate, and if the

correlation is positive or negative. The correlation coefficients are all based on the mean aggregation and significant correlations are marked by **, * or ^, indicating the significance of the correlation.

Table 4-2: Correlation matrix

	1	2	3	4	5
<i>Dependent variable</i>					
1.Report creative					
<i>Mediation variables</i>					
2. Relationship conflict	-,125**				
3. Task conflict	-,102**	,695**			
4. Process conflict	-,105**	,645**	,875**		
<i>Independent variables</i>					
5. Low richness com.	-,057^	,131**	,097**	,058	
6. High richness com.	,068*	,109**	,071*	,050	,305**

** . Correlation is significant at the 0,01 level (1-tailed).

* . Correlation is significant at the 0,05 level (1-tailed).

^ . Correlation is significant at the 0,1 level (1-tailed).

Table 4-2: Correlation matrix

From the correlation matrix above we see that low richness communication exhibits a slight negative correlation with the creative output (-0.057^), which is significant at the 10 percent level. On the other hand, high richness communication (0.068*) has a significant positive correlation with the creative output. All our process variables, relationship- (-0.125**), task- (-0.102**) and process (-0.105**) conflict shows a significant negative correlation with the creative output. Furthermore, relationship (0.131**) and task (0.097**) conflict has a significant positive correlation with low richness communication. Relationship (0.109**) and task (0.071*) conflict also share a significant positive relationship with high richness communication, while process conflict has no significant correlations with neither of the two communication variables. As a final remark, we note that there is quite strong correlation between our different conflict measures, which could indicate that one type of conflict is often accompanied with other types of conflict.

4.3 Hypotheses testing

In this chapter we will start by introducing multiple regressions of the direct relationship between low and high richness communication and the creative output (*H1a and H1b*). Thereafter, we present the multiple regressions of low and high richness communication on the process variables (*H2a and H2b*), followed by the regression results of the process variables on the creative output (*H3a, H3b and H3c*). Lastly, we present the results of the mediation analyses (*H4a and H4b*).

4.3.1 Multiple regression

We will in this subchapter present our results from the multiple regression analyses conducted using Hayes & Cai's (2007) heteroscedasticity-consistent regression model. For each multiple regression we will present a table with the coefficients, their corresponding standard errors and p-values, as well as the models F-values and R-squared.

4.3.1.1 The relationship between communication richness and creative output

In table 4-3 on the next page we see the direct relationship between low- and high richness communication and the creative output of the teams. The model is significant ($F = 3.684$, $p \leq 0.05$), which means that the model helps explain the variation in the teams' creative output. However, from the R-squared measure we see that the model only accounts for 1 percent of the variation in the creative output.

We also see that low richness communication has a significant negative relationship with the teams' creative output (Beta = -0.269, $p \leq 0.05$). Increased use of low richness communication is therefore negatively associated with the creative output in the teams. Furthermore, high richness communication has a significant positive relationship with the teams' creative output (Beta = 0.225, $p \leq 0.05$). This entails that increased use of high richness communication is positively associated with the creative output in the teams.

Table 4-3: multiple regression creative output

Dependent variable: Creative output			
	Coefficient	SE	P
Constant	5,200	0,279	0,000
<i>Independent variables</i>			
Low richness com.	-0,269	0,127	0,034
High richness com.	0,225	0,098	0,022
R-sq = 0.011			
F(2,767) = 3.684, p = 0.026			
<hr/>			
<i>N = 770</i>			

Table 4-3: Multiple regression: Creative output

From the multiple regression analysis we have therefore found support for hypothesis **H1a** and **H1b**, since increased high richness communication has a positive relationship with the creative output (**H1a**), while increased low richness communication shares a negative relationship with the creative output (**H1b**).

4.3.1.2 The relationship between communication richness and conflict

In table 4-4 below, we see how low- and high richness communication relate to the different process variables, namely relationship-, task- and process conflict. The model outlining the relationship between the richness of communication and relationship conflict is significant ($F = 5.367$, $p \leq 0.01$), as is the model relating the richness of communication to task conflict ($F = 3.355$, $p \leq 0.05$). The third model displays no significant relationship between the richness of communication and process conflict. In model 1, two percent of the variation in the teams occurrence of relationship conflict can be explained by the richness of communication, while in model 2 only one percent of the variation in the occurrence of task conflict is explained by the richness of communication.

Table 4-4: multiple regression: Process variables

	Model 1, dependent: Relationship conflict			Model 2, dependent: Task conflict			Model 3, dependent: Process conflict		
	Coefficient	SE	P	Coefficient	SE	P	Coefficient	SE	P
Constant	0,923	0,105	0,000	1,260	0,144	0,000	1,560	0,163	0,000
<i>Independent variables</i>									
Low richness com.	0,113	0,039	0,004	0,129	0,057	0,025	0,085	0,067	0,203
High richness com.	0,060	0,036	0,097	0,053	0,048	0,264	0,049	0,053	0,358
	R-sq = 0.023			R-sq = 0.011			R-sq = 0.005		
	F(2,767) = 5.367, p =0.005			F(2,767) = 3.355, p =0.035			F(2,767) = 1.427, p =0.241		

N = 770

Table 4-4: Multiple regression: Conflict variables

When it comes to the coefficients and the significance as well as the direction of the relationships we see that an increase in the frequency of low richness communication is associated with a significant increase in relationship conflict (Beta = 0.113, $p \leq 0.01$) and a significant increase in task conflict (Beta = 0.129, $p \leq 0.05$). Furthermore, an increase low richness communication is not significantly related to process conflict (Beta = 0.085, $p > 0.1$).

Increased use of high richness communication is also not significantly related to process conflict (Beta = 0.049, $p > 0.1$), it is also not significantly related to task conflict (Beta = 0.053, $p > 0.1$). However, increased use of high richness communication has a slight significant positive relationship with relationship conflict (Beta = 0.060, $p \leq 0.1$).

From the three sets multiple regression analyses we have presented here, we have found partial support for hypothesis **H2a** and hypothesis **H2b**. Increased use of high richness communication has a slightly significant ($p \leq 0.1$) positive relationships with relationship conflict. Furthermore, we find that increased low richness communication shares a significant positive relationship with the occurrence of both relationship- and task conflict. We therefore find partial support for hypothesis **H2a** and hypothesis **H2b**.

4.3.1.3 The relationship between conflict and creative output

In table 4-5 below we see the direct effect of how the different process variables relate to the creative output in the teams, controlled for the influence of high and low richness communication. The model is significant ($F = 3.831$, $p \leq 0.01$), which means that the model aids in explaining the variation of the teams creative output. The R-squared measure is almost three percent, and tells us how much of the variation in the creative output is the result of our process variables as well as our high- and low richness communication variables.

Table 4-5: Multiple regression: Processes and communication on creative output

Dependent variable: creative output			
	Coefficient	SE	P
Constant	5,589	0,300	0,000
<i>Control variables</i>			
Low richness com.	-0,230	0,130	0,078
High richness com.	0,246	0,098	0,012
<i>Independent variables</i>			
Relationship conflict	-0,312	0,174	0,074
Task conflict	0,033	0,160	0,839
Process conflict	-0,091	0,131	0,486
R-sq = 0.0281			
F(5,764) = 3.831, p = 0.002			

N = 770

Table 4-5: Multiple regression: Conflict and communication on creative output

The coefficients of the different conflict variables tell us how they relate to the creative output of the teams. Neither task conflict (Beta = 0.033, $p > 0.1$) nor process conflict (Beta = -0.091, $p > 0.1$) has a significant relationship with the creative outcome of the teams. However, relationship conflict shares a slightly significant negative relationship with the creative output of the teams (Beta = -0.312, $p \leq 0.1$). This indicates that the occurrence of relationship conflicts in teams is associated with a reduction in the creative output of the teams.

From the multiple regression analysis we have therefore found support for hypothesis **H3a**, since teams with more relationship conflicts produce less creative outputs. While we do not find support for our hypothesis that task conflict is positively associated with the creative outputs of the teams (**H3b**), nor do we find strong enough evidence to support our hypothesis that process conflict negatively relates to the creative output of the teams (**H3c**).

4.3.2 Mediation analysis

For both mediation analyses we will start by presenting the mediation model, which is derived from figure 2-1 present in chapter 2.7 with path coefficients and indications of statistical significance if present. We will then present a table with coefficients, standard errors, t-values and p-values. Lastly, we will present a table with 95 percent confidence intervals, which indicates whether or not we have significant mediation effects. All analyses have been conducted using heteroscedastic consistent errors and our 95 percent confidence intervals are achieved using 10.000 bootstrapped bias corrected samples.

4.3.2.1 Mediation: high richness communication

Figure 4-1 gives us an overview of the mediation model with coefficients for each path and significance indicators. The model has low richness communication as an independent variable, relationship, task and process conflict as mediators, and creative output as a dependent variable. The a-, b- and c- path coefficient we recognise from the multiple regression analyses done in subchapter 4.3.1. The c' coefficient is the effect of low richness communication that remain after we control for the mediators.

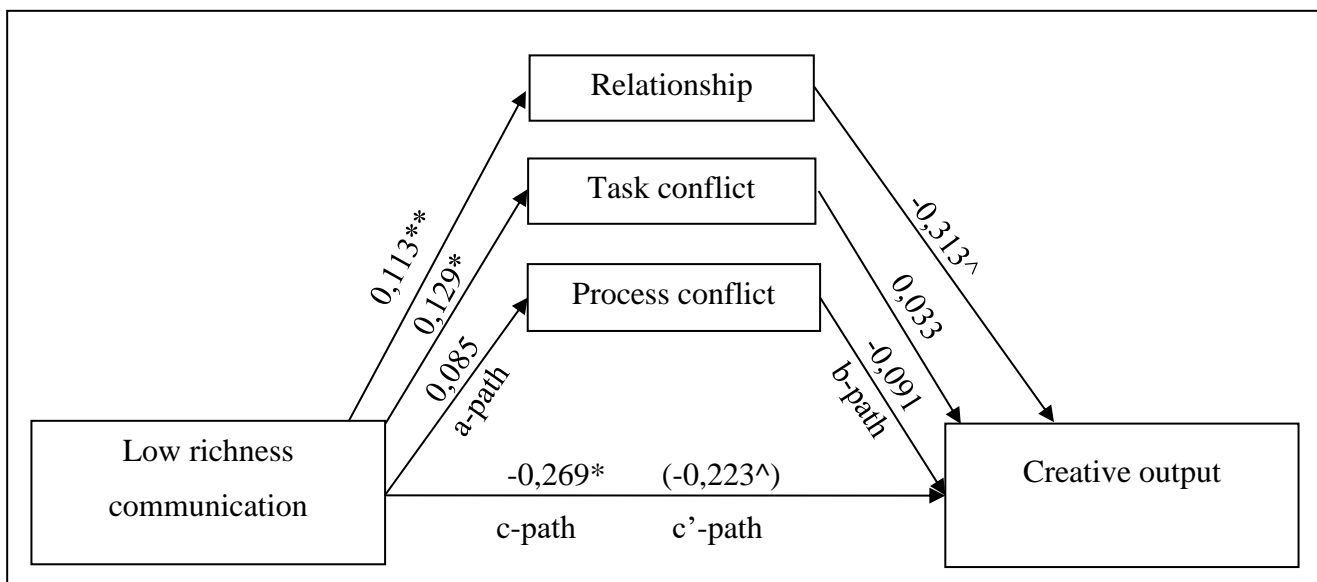

Figure 4-1: Low richness mediation

Table 4-6: Path coefficients: Low richness communication tools on creative output

	Beta	SE	t	p
<i>Low richness communication on mediators, a-paths</i>				
Relationship conflict	0,113	0,039	2,889	0,004
Task conflict	0,129	0,057	2,248	0,025
Process conflict	0,085	0,067	1,274	0,203
<i>Mediators on creative output, b-paths</i>				
Relationship conflict	-0,313	0,174	-1,79	0,074
Task conflict	0,033	0,160	0,203	0,839
Process conflict	-0,091	0,130	-0,697	0,486
<i>total effect of Low richness communication on results, c-path</i>				
Low richness communication	-0,269	0,127	-2,12	0,034
<i>Direct effect of Low richness communication on results, c'-path</i>				
low richness communication	-0,223	0,130	-1,766	0,078

N = 770, controlling for the influence of high richness communication

Table 4-6: Path coefficients: Low richness on creative output

From figure 4-1 and table 4-6 above we see that the a-paths from low richness communication to relationship conflict (Beta = 0.113, $p \leq 0.01$) and task conflict (Beta = 0.129, $p \leq 0.05$) are significant, while low richness communication does not significantly relate to process conflict. Looking at the b-paths, only relationship (Beta = -0.313, $p \leq 0.05$) conflict shares a significant negative relationship with the creative outcome, task- and process conflict however, does not indicate a significant relationship with the creative outcome.

Therefore, since we evidence for a significant relationship for relationship conflict on both the a- and b-path, there is a possibility that relationship conflict might mediate the relationship. However, we can only assert that there is a mediation effect if the 95 percent confidence interval of the indirect effect does not contain zero. As we see below from table 4-7, we find that relationship conflict mediates the negative relationship between low richness communication and creative output, as the 95 % confidence interval does not contain zero.

Table 4-7: Confidence intervals: Mediation effects of low richness communication on creative output

<i>Indirect effects</i>	Beta	95% Confidence interval
Total effect	-0,039	[-0.093 , -0.002]
Relationship conflict	-0,035	[-0.097 , -0.002]
Task conflict	0,004	[-0.038 , 0.055]
Process conflict	-0,008	[-0.061 , 0.010]

N = 770

Table 4-7: Confidence intervals: Low richness mediation

In conclusion we find support for hypothesis **H4b**, since low richness communication has a negative indirect effect on creative output through relationship conflict.

4.3.2.2 Mediation: high richness communication

Figure 4-2 gives us an overview of the mediation model with coefficients for each path and significance indicators. The model has high richness communication as an independent variable, relationship, task and process conflict as mediators, and creative output as a dependent variable. The a-, b- and c- path coefficient we recognise from the multiple regression analyses done in subchapter 4.3.1. The c' coefficient is the effect of high richness communication that remain after we control for the mediators.

*Figure 4-2: High richness mediation*

Table 4-8: Path coefficients: High richness communication on creative output

	Beta	SE	t	p
<i>High richness communication on mediators, a-paths</i>				
Relationship conflict	0,060	0,036	1,662	0,097
Task conflict	0,053	0,048	1,117	0,264
Process conflict	0,049	0,053	0,920	0,358
<i>Mediators on creative output, b-paths</i>				
Relationship conflict	-0,313	0,174	-1,792	0,074
Task conflict	0,033	0,160	0,203	0,839
Process conflict	-0,091	0,131	-0,697	0,486
<i>total effect of High richness communication on results, c-path</i>				
High richness communication	0,225	0,098	2,290	0,022
<i>Direct effect of High richness communication on results, c'-path</i>				
High richness communication	0,246	0,098	2,524	0,012
<i>Net effect of High richness communication on results, controlling for the influence of low richness communication</i>				

Table 4-8: Path coefficients: High richness communication on creative output

From figure 4-2 and table 4-8 above we see that the a-path from high richness communication to relationship conflict (Beta = 0.060, $p \leq 0.1$) is slightly significant. Neither task conflict (Beta = 0.053, $p > 0.1$) or process conflict (Beta = 0.049, $p > 0.1$) is significant. In addition there is no significant relationship between task conflict and the creative output (Beta = 0.033, $p > 0.1$), this means that we can't expect to find a mediation effect through task conflict. However, we can only assert that there is no mediation effect if the 95 percent confidence interval of the indirect effect does not contain zero. As we see below from table 4-9, we do not find support for our hypothesis that a positive relationship between high richness communication and creative output is mediated through task conflict, even though there is a significant positive relationship between high richness communication and the creative output (Beta = 0.224, $p \leq 0.05$) when controlling for the conflict variables, as the 95 % confidence interval contain zero.

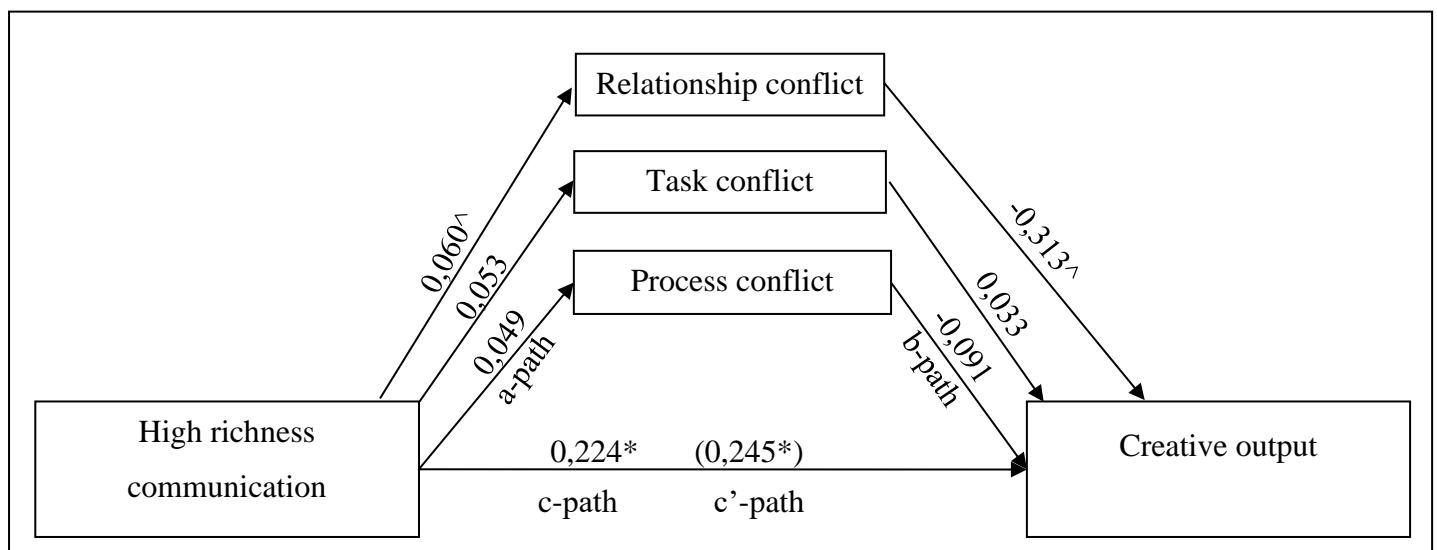
Table 4-9: Confidence intervals: Mediation effects of high richness communication on creative output

<i>Indirect effects</i>	Beta	95% Confidence interval
Total effect	-0,022	[-0.075 , 0.004]
Relationship conflict	-0,019	[-0.076 , 0.001]
Task conflict	0,002	[-0.015 , 0.036]
Process conflict	-0,005	[-0.043 , 0.007]

N = 770

Table 4-9: Confidence intervals: High richness mediation

To sum up, we do not find support for hypothesis **H4a**, since high richness communication has no indirect effect on the creative output through task conflict, or any of the other process variables.

4.3.3 Summary of the hypotheses testing

In table 4-10 below, we summarise our findings and indicate whether our hypotheses gain support.

Table 4-10: Summary of findings

Hypothesis	Conclusion	Summary of finding
H1a	<i>Support</i>	High richness communication is positively related to the teams creative output
H1b	<i>Support</i>	Low richness communication is negatively related to the teams creative output
H2a	<i>Partial support</i>	Use of high richness communication is positively related to the amount of relationship conflicts in the teams
H2b	<i>Partial support</i>	Use of low richness communication is positively related to the amount of relationship and task conflicts in the teams
H3a	<i>Support</i>	Relationship conflict is negatively related to the teams creative output
H3b	<i>No support</i>	Task conflict is not related to the teams creative output
H3c	<i>No support</i>	Process conflict is not related to the teams creative output
H4a	<i>No support</i>	The frequency of task conflict does not mediate the positive relationship between rich communication and the teams creative output
H4b	<i>Support</i>	The frequency of relationship conflict mediates the negative relationship between low richness communication and the teams creative output

Table 4-10: Summary of hypotheses testing

4.4 Additional analysis

The hypotheses tested in chapter 4.3 are tested against the professors' evaluation of the creative outcome of the teams report. In this section we will perform the mediation analyses using the teams' subjective measure of creative outcome as the dependent variable. We believe that the inclusion of the teams' subjective measure is interesting since it illustrates how the teams perceived the relationship between communication richness and their creative output.

4.4.1 Low richness communication and perceived creative output

From table 4-11 below we see that the c-path is significant (Beta = 0.138, $p \leq 0.05$), which means that there is a significant positive relationship between low richness communication and the perceived creativity of the teams' output.

Table 4-11: Path coefficients: Low richness communication tools on perceived creative output

	Beta	SE	t	p
<i>Low richness communication on mediators, a-paths</i>				
Relationship conflict	0,113	0,039	2,89	0,004
Task conflict	0,1291	0,0583	2,215	0,027
Process conflict	0,085	0,0688	1,2353	0,217
<i>Mediators on creative output, b-paths</i>				
Relationship conflict	0,028	0,073	0,391	0,696
Task conflict	-0,117	0,077	-1,525	0,128
Process conflict	-0,079	0,062	-1,285	0,203
<i>Total effect of Low richness communication on perceived creative output, c-path</i>				
Low richness communication	0,138	0,058	2,403	0,017
<i>Direct effect of Low richness communication on perceived creative output, c'-path</i>				
low richness communication	0,157	0,057	2,753	0,006

N = 770, controlling for the influence of high richness communication

Table 4-11: Path coefficients: Low richness communication and perceived creative output (mediation)

Furthermore, the a-paths are the same as in the analysis done in subchapter 4.3.1. However, the b-paths now show no significant relationship between conflict and the perceived creative output. This is quite interesting, since the frequency of conflict does not seem to play a role in how the teams perceived their own creative output. It is also worth noting that relationship conflict has a positive relationship with the perceived creativity of the team output while task conflict has a negative relationship with the perceived creativity of the team output, although not at a significant level.

As we do not have any significant b-paths we do not expect to find support that conflict mediates the relationship between low richness communication and how creative the teams perceived their output to be. The mediation output can be found in appendix 4-2.

4.4.2 High richness communication and perceived creative output

Interestingly when we performed the mediation analyses using high richness communication and teams perceived creative output we did not find any significant direct or total effects. This entails that increasing the frequency of high richness communication does not seem to have any effect on how creative the teams perceived their output to be. In addition, the frequency

of conflict did not have a significant impact on the perceived creativity of the teams' output. We therefore did not find any mediating effects of high richness communication and the perceived creative output. In appendix 4-2 we present the regression output and the mediation analysis of high richness communication on perceived creative output.

5. Discussion

Our main goal of this study was to add value to the existing literature by further investigating what makes global virtual teams produce creative output. This relationship is important to understand since 46 % of organisations used virtual teams in 2012 (Society for Human Resource Management, 2012), and global virtual teams are considered important when companies want to create innovations (Jones, 2009; Wuchty et al., 2007). There has however been limited research regarding creativity in global virtual teams (Gilson et. al., 2015), and the novel findings in this study contribute to the understanding of creativity in global virtual teams.

We have found that the increased use of high richness communication has a direct positive relationship with the creative output in global virtual teams, while holding the use of low richness communication constant. Conversely, we found that global virtual teams who used more low richness communication, while holding the use of high richness communication constant had a negative relationship with the creative output in global virtual teams. Furthermore, we found that an increase in high richness communication shared a slight positive relationship with the occurrence of relationship conflict. On the other hand, increased communication frequency using low richness tools was related to an increase in task conflicts as well as relationship conflicts. We also find evidence that some of the negative relationship between the increased use of low richness communication and the creative output is mediated through the frequency of relationship conflict. No indirect relationship between increased use of high richness communication and creative output were found. Our findings suggest that increasing high richness communication enhances creative output in global virtual teams, and that increasing low richness communication can hamper the creative output.

As far as we know, this study is the first quantitative study to examine the relationship between frequency of communication of different richnesses and the creative output of global virtual teams. Our findings therefore provide new and interesting results on how global virtual teams' creativity is affected by different types of online communication. In the chapters below we discuss the theoretical- and managerial implications of this study, as well as its limitations and suggestions for further research. We finish off this study by presenting our conclusion.

5.1 Theoretical implications

5.1.1 Relationships between communication and creativity

In our analysis we found that there was a significant direct relationship between the frequency of use of low and high richness communication tools and creativity. Interestingly, we found an inverse effect between the two communication categories' relationship with team creativity. While increased use of high richness communication tools increased creative output, increased use of low richness communication tools hampered creativity. This is in line with the theoretical concepts which suggests that richer communication tools are better suited when solving creative tasks (Daft & Lengel, 1986; Nemiro 2004; Suh 1999). We have also previously argued that in order to solve complex tasks, which is the case for the teams in our study, it is important for the teams to share and integrate information between each other. Richer communication tools have been found to be better suited for such tasks (Curşeu et al., 2008; Cramton, 2001), while low communication tools fails to do so, due to lack in the immediacy of feedback. This effect reduces the amount of knowledge sharing and development of mutual knowledge in virtual teams (Cramton 2001), which is needed for successfully produce creative output (Nemiro, 2004). Our findings illustrate that the choice of different communication tools and the richness that they offer has consequences for the creative output produced in global virtual teams.

Interestingly, our additional analysis of the relationship between low richness communication and the teams' subjective rating of the creative output yielded a significant positive result. On the other hand, no significant relationship between high richness communication and the teams' subjective rating of creative output was detected. We find it fascinating that while teams who increased their communication with low richness tools gave their output a higher score in terms of creativity than did teams who communicated less frequent with low richness tools. Therefore it seems that although more low richness communication resulted in teams perceiving themselves as more creative, the relationship is negative when it comes to the actual creative output rated by the professors.

5.1.2 Relationships between communication and conflict

We expected that both high- and low richness communication tools would lead to increased conflict, indicating that global virtual teams would be more prone to conflicts as all communication is mediated. This expectation was based on the literature review we discussed that mediated communication in general reduces the feeling of “being there” (Short et al., 1976; Yoo & Alavi, 2001) and due to reduction in contextual, nonverbal and social cues reduces the teams ability to build relationships (Hinds & Bailey, 2003), cohesion (Straus & McGrath, 1994), group identity (Bouas & Arrow, 1995) and increases competitive behaviours (Purdy et al., 2000).

We found that increased use of low richness communication tools increased task and relationship conflict, but not process conflict. Furthermore, we found that high richness communication tools only increased relationship conflicts. In chapter 2.4 we discussed that high richness communication could reduce the negative effects of mediated communication (Daft & Lengel, 1987) since richer communication tools are more effective at facilitating a shared meaning. Reversely, low richness communication tools are shown to increase relationship conflicts (Cramton, 2001; Markus 1994; Kankanhalli et al., 2006), process conflicts (Deutsch, 1969, Goodman & Leyden, 1991) and task conflict (Jehn et al., 1997; Kankanhalli et al., 2006). Therefore, we expected that low richness communication tools would have a stronger relationship with conflict than high richness communication tools.

When looking at the beta values of low richness communication tools on relationship conflict (0.113**), task conflict (0.129*) and process conflict (0.085), we see that they are somewhat higher than the beta values of high richness communication tools being (0.060^), (0.053) and (0.049) respectively. This is line with the literature stating that high richness communication can mitigate some of the negative effects of mediated communication (Daft & Lengel, 1987). Surprisingly, neither low nor high richness communication tools significantly increased process conflict. This is surprising as global virtual teams are sometimes situated across various time zones which implicates that scheduling synchronous meetings should be challenging. Additionally, research has shown that low familiarity among team members paired with uncertainty about when team members work increases the likeliness of process

conflicts (Deutsch, 1969, Goodman & Leyden 1991), which is likely the case for our teams. A possible explanation for this might be related to our measurement of conflict, since the correlation between task and process conflict was above 0.8. The correlation might suggest that some team members misperceived the type of conflict they were experiencing (Simon & Peterson, 2000). In summary, we find that global virtual teams are exposed to conflicts, but the negative effects of conflict on creativity seems to be mitigated by the increased use of high richness communication tools.

5.1.3 Relationships between conflict and creativity

Based on the discussions in chapter 2.5 we expected to find that relationship conflict would reduce the creative output. We did find a marginally significant relationship with a beta of -0.313^{\wedge} , indicating that one more relationship conflict per week would result in a reduction in the creative output variable of 0.313, which is a 4,5 % reduction from the mean creative score. This finding is in line with previous research that also found a negative relationship between relationship conflict and creativity (Hu et al., 2017; Chen & Chang, 2005; He et al., 2014; Yong et al., 2014; Amabile and Kurtzberg 2001). Our study brings value to the existing research by showing that this relationship is also present in global virtual teams.

In terms of task conflict, there were various findings in the literature. Some researchers stated that task conflict was negatively related to creativity (He et al., 2014; Yong et al., 2014), others that it had a positive relationship (Lu et al., 2011; Hu et al., 2017; Chen & Chang, 2005) and others saying that it depends on the level of task conflict (Jehn, 1995). Our findings did however not find any relationship between task conflict and creativity in global virtual teams. This might be due to the way conflict is measured in our study.

Neither did we find any relationship between process conflict and creativity, even though the literature suggest there should be one (Amabile and Kurtzberg, 2001). This was however a little surprising as diversity is found to lead to conflict due to coordination and communication difficulties (Kirton 1976, 1989), which are common attributes for process conflicts (Jehn, 1997). Diversity is one of the main characteristics of global virtual teams (Bergiel et al., 2008) and mediated communication is found to lead to further misunderstandings (Cramton, 2001;

Andres, 2012), which makes it surprising that there is no significant relationship between process conflict and the creative output in global virtual teams.

5.1.4 Mediating effects

In addition to finding a direct link between the frequency of low richness communication and creativity, we find that some of the negative relationship is mediated through the occurrence of relationship conflict. This adds to the understanding of how the richness of communication can influence global virtual teams creative output. Our study shows that the occurrence of relationship conflict is a team process that not only arises from increased low richness communication, but that also translates into reduced creative output.

We looked for indirect effects in an effort to explain the positive direct relationship between the frequency of high richness communication and the creative output, with no significant results. As we discussed above, the literature provide multiple ways in which task conflict can be beneficial or detrimental to the creative output in teams. However, we do not find any significant effects between task conflict and creativity in global virtual teams. This could perhaps be explained by the high correlation between process and task conflict, since teams might have confused these two conflicts. There might however be other factors or processes which are unobservable in our study such as the way conflict is handled or the severity of the conflicts which might better explain how task conflict relates to the creative output in teams.

5.1.5 Summary

In our study we measure creativity as the creative output of a newly formed global virtual teams who work to solve a complex real-world business problem over a short, predetermined time frame. Our finding that the frequency of communication categorised by media richness plays a role in determining the creative output provides novel insight into the area of creativity and communication in global virtual teams. We also contribute to the literature by indicating that low richness communication has a negative indirect effect on the creative output through relationship conflict. In addition, we further add to the understanding of conflict and creativity by examining this relationship in the context of global virtual teams. Our findings in total give

valuable contributions to the literature and provides multiple avenues for further research into how creativity in global virtual teams can be fostered, which is further discussed in chapter 5.3.

5.2 Managerial implications

As described in the introduction, the purpose of this study has been to expand the knowledge on the use of different richness communication tools in global virtual teams. Since global virtual teams are becoming more widely used, understanding how to leverage their potential and avoiding pitfalls is important. Our research indicates that global virtual teams that place a higher emphasis on high richness communication end up with more creative output. Inversely, the creative output will be hampered by increased use of low richness communication tools, when tasks are complex. Therefore, we suggest that companies should facilitate and encourage their workers to use richer communication tools, as opposed to leaner tools when working on complex and creative tasks with for example colleagues, customers, suppliers, partners or other stakeholders. Furthermore, our research indicates that minimising relationship conflict is important for the creative output, and that possibly high richness communication to a lesser extent than low richness communication increases this type of conflict. As a consequence managers and organisations should promote and facilitate for global virtual teams to increasingly rely on high richness communication when engaging with complex and creative tasks.

5.3 Limitations and further research

5.3.1 Measurement challenges

As the majority of the data used in this study is gathered with the help of self-reported surveys, there are some limitations when it comes to the subjective interpretations of the questions in the surveys. This might be particularly prominent for the conflict measures used in this study. There is a chance that some team members might misperceive the type of conflict they are experiencing (Simon & Peterson, 2000), which in turn can lead to our conflict measures being inadequate in measuring the actual frequencies of relationship- task- and process conflict. Our

suspicions are made stronger due to the strong correlation between task - and process conflict. Confusing the type of conflict experienced is particularly relevant in our study as our teams are newly formed and highly diverse, which makes the team members more likely to confuse the different types of conflicts due to lack of deeper knowledge about other team members (Gruenfeld, Mannix, Williams, & Neale, 1996).

Furthermore, we are only able to measure the frequency of conflict, which might not be the optimal way to measure conflict. Some teams might have experienced multiple small conflicts which had turned out to have a small impact on the creative output, while other teams might have experienced one major conflict which might have had a larger impact. Our study does not provide data to take these nuances into account which is a considerable limitation of the study. A common research approach used to more accurately gauge the degree and impact of conflict has been to apply a multiple-item measurement on a likert scale (Jehn, 1995; Simons & Peterson, 2000; Bai, Lin, & Li, 2016). Therefore, the way conflict is measured in this study raises a limitation as it does not take into account the degree or impact of conflict, but merely the frequency of conflict. As a consequence, we propose that further studies should focus on the severity of conflict, and potentially the effects different conflict handling styles plays on the links between communication frequency and conflict, and by extension creativity.

Our measure for communication frequency and type is measured after the end of the project period, while the conflict measure is collected on a weekly basis. Therefore a causal link between communication and conflict becomes problematic to establish, since a back-and-forth relationship between the two variables can emerge. For instance communication can lead to a conflict, and that conflict may in turn lead to less or more communication. The gathering of the data in this study does not let us measure any such interactions, which poses a limitation on our study when it comes to making causal statements of the relationship between communication frequency and conflict, and by extension the indirect effect of communication on creativity through conflict. Future studies should aim to clearly decouple communication and conflict in global virtual teams, for example by measuring communication frequency and type at the same intervals during the observation period.

The way in which this study measures creativity can also be considered a limitation. Our measure of creativity is the rating of the participating professors' judgement of the creative

output. Another prominent measure of creativity can however also be measured by the number of ideas created, the quality of good ideas and range of different ideas (Guilford, 1959; Girotra, Terwiesch, & Ulrich, 2009). As our study only takes into account the idea that was presented in the submitted business case, there is a possibility that a team produced many high quality ideas that were not chosen for the final report. Therefore, we are only able to confidently talk about the creative output of the global virtual teams, which might not necessary provide a full picture of the creative processes of the teams. It does however serve as a strong indicator of the creative processes, since a high creative output is likely to have arisen from teams who have produced multiple high quality ideas and managed to decide on the best one, not only in terms of creativity but in terms of viability for the business case as well. However, we suggest further research should look into how the different stages of the creative process in global virtual teams should be supported by communication technology, which is an interesting topic that might help guide global virtual teams to leverage their potential.

We also need to point out that although we find significant relationships in this study, their explanatory power is somewhat limited. For example, we conclude that both low and high richness communication relates to the creative output of the teams, but that the communication variables only account for a small part of the variation observed in the creative output. This moderates our findings somewhat, even though we still champion the findings relevance for the literature and practitioners. A potential reason for the low explanatory power might be that we are unfortunately only able to measure the frequency of communication, but have no observations of the quality of teams' interactions.

5.3.2 Categorisation of communication tools

Categorising the different communication tools was challenging and poses a limitation. Most of the communication tools used in the study offer multiple functionalities which makes no tool exclusively used for video, voice or text-chat, except for email. We justified the categorisation by the tools primary functionality, leading us to put WhatsApp and Viber in the low richness category, even though they offer phone calls and voice messages. Similarly, Skype is most commonly used for videoconferences but does also include text-chat, therefore we put Skype in the high richness category. Another limitation is that the use of different tools were measured in the end of the project period (in week 10), suggesting that participants might

not accurately remember how much and how frequent they used the different communication tools.

Lastly, one could also categorise the different communication tools based on a more strict criteria, such as: lack of video functionality. However, we believe that categorising based on whether the primary functionality of the tool is text-based or a not makes sense, since it is hard to gauge whether a team communicating through Skype had video enabled or not. Additionally the main types of communication tools used by virtual teams offer multiple types of communication. In the end, we decided to create our categories based on Nemiro's (2004) criteria, making our findings easily interpretable in light of the existing literature.

We found a mediation effect between low richness communication tools and creativity while we did not gain support for the mediation between high richness communication tools and creativity. Therefore it is interesting to understand if other team processes can explain this relationship. Research attention should thus be called towards other explanatory factors, which can highlight how the relationship between high and low richness communication and creativity is mediated in global virtual teams.

6. Conclusion

Global virtual teams are becoming a widespread phenomenon. Advancements in communication technology have made it possible for individuals across the globe to work together without sharing the same location. In response, organisations have to a larger degree taken advantage of global virtual teams in order to harness creativity and create innovations. While research on global virtual teams have become increasingly common in the past years, there is limited research on creativity in global virtual teams, and this study aims to provide some more insight into this field.

With data from the X - culture project we have discovered that the use of both high - and low richness communication tools impacts creativity. We find however an inverse relationship between the two. While increased use of high richness communication is positively related to the creative output, increased use of low richness communication is negatively related to the creative output. Low richness communication has a stronger positive relationship with the occurrence of relationship conflict than high richness communication, which seems to indirectly explain parts of the negative relationship between increased low richness communication and creative output. For high richness communication tools, the positive relationship towards creative output cannot be explained through any of the conflict variables, indicating that more research is needed in order to understand the positive relationship we find.

As a consequence of our findings, we advice global virtual teams to place a greater emphasis on high richness communication tools when solving complex problems, where creativity is an important part of the solution. We hope that these insights can guide global virtual teams going forward. Our study also adds to the existing literature on global virtual teams, by establishing links between the richness and frequency of communication and the creative output.

7. References

Amabile, T. M. (1996). *Creativity in context: Update to the social psychology of creativity*. Hachette UK.

Amabile, T. M., Conti, R., Coon, H., Lazenby, J., & Herron, M. (1996). Assessing the work environment for creativity. *Academy of management journal*, 39(5), 1154-1184.

Amabile, T. M. (1983). The social psychology of creativity: A componential conceptualization. *Journal of personality and social psychology*, 45(2), 357-376.

Andres, H. P. (2012). Technology-mediated collaboration, shared mental model and task performance. *Journal of Organizational and End User Computing (JOEUC)*, 24(1), 64-81.

Axtell, C. M., Fleck, S. J., & Turner, N. (2004). Virtual teams: Collaborating across distance. *International review of industrial and organizational psychology*, 19, 205-248.

Bagozzi, R. P., Yi, Y., & Phillips, L. W. (1991). Assessing construct validity in organizational research. *Administrative science quarterly*, 421-458.

Bai, Y., Lin, L., & Li, P. P. (2016). How to enable employee creativity in a team context: A cross-level mediating process of transformational leadership. *Journal of Business Research*, 69(9), 3240-3250.

Barlett, J. E., Kotrlik, J. W., & Higgins, C. C. (2001). Organizational research: Determining appropriate sample size in survey research. *Information technology, learning, and performance journal*, 19(1), 43.

Bassett-Jones, N. (2005). The paradox of diversity management, creativity and innovation. *Creativity and innovation management*, 14(2), 169-175.

Bergiel, B. J., Bergiel, E. B., & Balsmeier, P. W. (2008). Nature of virtual teams: a summary of their advantages and disadvantages. *Management Research News*, 31(2), 99-110.

- Biemann, T., Cole, M. S., & Voelpel, S. (2012). Within-group agreement: On the use (and misuse) of rWG and rWG (J) in leadership research and some best practice guidelines. *The Leadership Quarterly*, 23(1), 66-80.
- Bliese, P. D. (1998). Group size, ICC values, and group-level correlations: A simulation. *Organizational research methods*, 1(4), 355-373.
- Bouas, K. S., & Arrow, H. (1995). The development of group identity in computer and face-to-face groups with membership change. *Computer supported cooperative work (CSCW)*, 4(2-3), 153-178.
- Bourgeois III, L. J. (1985). Strategic goals, perceived uncertainty, and economic performance in volatile environments. *Academy of management journal*, 28(3), 548-573.
- Bowerman, B. L., & O'connell, R. T. (1990). *Linear statistical models: An applied approach*. Brooks/Cole.
- Brehmer, B. (1976). Social judgment theory and the analysis of interpersonal conflict. *Psychological bulletin*, 83(6), 985.
- Campbell, D. T. (1960). Blind variation and selective retentions in creative thought as in other knowledge processes. *Psychological review*, 67(6), 380-400.
- Carnevale, P. J., & Probst, T. M. (1998). Social values and social conflict in creative problem solving and categorization. *Journal of personality and social psychology*, 74(5), 1300.
- Chang, S., Jia, L., Takeuchi, R., & Cai, Y. (2014). Do high-commitment work systems affect creativity? A multilevel combinational approach to employee creativity. *Journal of Applied Psychology*, 99(4), 665.
- Chen, M. H., & Chang, Y. C. (2005). The dynamics of conflict and creativity during a project's life cycle: A comparative study between service-driven and technology-driven teams in Taiwan. *International Journal of Organizational Analysis*, 13(2), 127-150.
- Clark, H. H., & Brennan, S. E. (1991). Grounding in communication. *Perspectives on socially shared cognition*, 13(1991), 127-149.

- Cramton, C. D. (2001). The mutual knowledge problem and its consequences for dispersed collaboration. *Organization science*, 12(3), 346-371.
- Curşeu, P. L., Schalk, R., & Wessel, I. (2008). How do virtual teams process information? A literature review and implications for management. *Journal of Managerial Psychology*, 23(6), 628-652.
- Daft, R. L., & Lengel, R. H. (1986). Organizational information requirements, media richness and structural design. *Management science*, 32(5), 554-571.
- Daft, R. L., Lengel, R. H., & Trevino, L. K. (1987). Message equivocality, media selection, and manager performance: Implications for information systems. *MIS quarterly*, 355-366.
- De Dreu, C. K., & Gelfand, M. J. (Eds.). (2008). *The psychology of conflict and conflict management in organizations* (pp. 3-54). New York: Lawrence Erlbaum Associates.
- Dekker, D. M., Rutte, C. G., & Van den Berg, P. T. (2008). Cultural differences in the perception of critical interaction behaviors in global virtual teams. *International Journal of Intercultural Relations*, 32(5), 441-452.
- Deutsch, M. (1969). Conflicts: Productive and destructive. *Journal of social issues*, 25(1), 7-42.
- Dyne, L., & Saavedra, R. (1996). A naturalistic minority influence experiment: Effects on divergent thinking, conflict and originality in work-groups. *British Journal of Social Psychology*, 35(1), 151-167.
- Easterby-Smith, M., Lyles, M. A., & Tsang, E. W. (2008). Inter-organizational knowledge transfer: Current themes and future prospects. *Journal of management studies*, 45(4), 677-690.
- Eisenhardt, K. M., & Schoonhoven, C. B. (1990). Organizational growth: Linking founding team, strategy, environment, and growth among US semiconductor ventures, 1978-1988. *Administrative science quarterly*, 504-529.
- Field, A. (2009). *Discovering statistics using SPSS*. Sage publications.

Fuchs, C., & Diamantopoulos, A. (2009). Using single-item measures for construct measurement in management research: Conceptual issues and application guidelines. *Die Betriebswirtschaft*, 69(2), 195.

Fussell, S. R., & Krauss, R. M. (1992). Coordination of knowledge in communication: Effects of speakers' assumptions about what others know. *Journal of personality and Social Psychology*, 62(3), 378.

Gassmann, O. (2001). Multicultural teams: Increasing creativity and innovation by diversity. *Creativity and Innovation Management*, 10(2), 88-95.

Gelman, A., & Hill, J. (2007). *Data analysis using regression and multilevel hierarchical models* (Vol. 1). New York, NY, USA: Cambridge University Press.

Ghauri, P. N., & Grønhaug, K. (2010). *Research methods in business studies*. Harlow: Pearson education Limited.

Gibson, C. B., & Cohen, S. G. (2003). Virtual teams that work. *JosseyBass, San Francisco*.

Giddens, A. (1984). *The constitution of society: Outline of the theory of structure*. Berkeley.

Gilson, L. L., Maynard, M. T., Jones Young, N. C., Vartiainen, M., & Hakonen, M. (2015). Virtual teams research: 10 years, 10 themes, and 10 opportunities. *Journal of Management*, 41(5), 1313-1337.

Girotra, K., Terwiesch, C., & Ulrich, K. T. (2010). Idea generation and the quality of the best idea. *Management science*, 56(4), 591-605.

Goodman, P. S., & Leyden, D. P. (1991). Familiarity and group productivity. *Journal of Applied Psychology*, 76(4), 578.

Gruenfeld, D. H. (1995). Status, ideology, and integrative complexity on the US Supreme Court: Rethinking the politics of political decision making. *Journal of Personality and Social Psychology*, 68(1), 5.

Gruenfeld, D. H., Mannix, E. A., Williams, K. Y., & Neale, M. A. (1996). Group composition and decision making: How member familiarity and information distribution affect process and performance. *Organizational behavior and human decision processes*, 67(1), 1-15.

Guilford, J. (1959). *Personality*. New York: McGraw - Hill.

Han, H. J., Hiltz, S. R., Fjermestad, J., & Wang, Y. (2011). Does medium matter? A comparison of initial meeting modes for virtual teams. *IEEE transactions on professional communication*, 54(4), 376-391.

Havlicek, L. L., & Peterson, N. L. (1977). Effect of the violation of assumptions upon significance levels of the Pearson r. *Psychological Bulletin*, 84(2), 373.

Hayes, A. F. (1996). Permutation test is not distribution-free: Testing $H_0: \rho = 0$. *Psychological Methods*, 1(2), 184-198.

Hayes, A. F. (2013). *Introduction to mediation, moderation, and conditional process analysis: A regression-based approach*.

Hayes, A. F., & Cai, L. (2007). Using heteroskedasticity-consistent standard error estimators in OLS regression: An introduction and software implementation. *Behavior research methods*, 39(4), 709-722.

He, Y., Ding, X. H., & Yang, K. (2014). Unpacking the relationships between conflicts and team innovation: Empirical evidence from China. *Management Decision*, 52(8), 1533-1548.

Hinds, P. J., & Bailey, D. E. (2003). Out of sight, out of sync: Understanding conflict in distributed teams. *Organization science*, 14(6), 615-632.

Hinds, P. J., & Mortensen, M. (2005). Understanding conflict in geographically distributed teams: The moderating effects of shared identity, shared context, and spontaneous communication. *Organization science*, 16(3), 290-307.

Hollingshead, A. B. (1996). Information suppression and status persistence in group decision making: The effects of communication media. *Human Communication Research*, 23(2), 193-219.

Hollingshead, A. B., McGrath, J. E., & O'Connor, K. M. (1993). Group task performance and communication technology: A longitudinal study of computer-mediated versus face-to-face work groups. *Small group research*, 24(3), 307-333.

Hu, N., Chen, Z., Gu, J., Huang, S., & Liu, H. (2017). Conflict and creativity in inter-organizational teams: The moderating role of shared leadership. *International Journal of Conflict Management*, 28(1), 74-102.

Hunter, S. T., Bedell, K. E., & Mumford, M. D. (2007). Climate for creativity: A quantitative review. *Creativity research journal*, 19(1), 69-90.

James, K. (1995). Goal conflict and originality of thinking. *Creativity Research Journal*, 8(3), 285-290.

Janis, I. L. (1972). Victims of groupthink: a psychological study of foreign-policy decisions and fiascoes.

Jarvenpaa, S. L., Knoll, K., & Leidner, D. E. (1998). Is anybody out there? Antecedents of trust in global virtual teams. *Journal of management information systems*, 14(4), 29-64.

Jarvenpaa, S. L., & Leidner, D. E. (1999). Communication and trust in global virtual teams. *Organization science*, 10(6), 791-815.

Jarvenpaa, S. L., Shaw, T. R., & Staples, D. S. (2004). Toward contextualized theories of trust: The role of trust in global virtual teams. *Information systems research*, 15(3), 250-267.

Jehn, K. A. (1995). A multimethod examination of the benefits and detriments of intragroup conflict. *Administrative science quarterly*, 256-282.

Jehn, K. A. (1997). A qualitative analysis of conflict types and dimensions in organizational groups. *Administrative science quarterly*, 530-557.

Jehn, K. A., Chadwick, C., & Thatcher, S. M. (1997). To agree or not to agree: The effects of value congruence, individual demographic dissimilarity, and conflict on workgroup outcomes. *International journal of conflict management*, 8(4), 287-305.

Jehn, K. A., Northcraft, G. B., & Neale, M. A. (1999). Why differences make a difference: A field study of diversity, conflict and performance in workgroups. *Administrative science quarterly*, 44(4), 741-763.

Joinson, C. (2002). Managing virtual teams. *HR magazine*, 47(6), 68-73.

Jong, R., Schalk, R., & Curşeu, P. L. (2008). Virtual communicating, conflicts and performance in teams. *Team Performance Management: An International Journal*, 14(7/8), 364-380.

Jones, B. F. (2009). The burden of knowledge and the “death of the renaissance man”: Is innovation getting harder?. *The Review of Economic Studies*, 76(1), 283-317.

Kanawattanachai, P., & Yoo, Y. (2002). Dynamic nature of trust in virtual teams. *The Journal of Strategic Information Systems*, 11(3-4), 187-213.

Kankanhalli, A., Tan, B. C., & Wei, K. K. (2006). Conflict and performance in global virtual teams. *Journal of management information systems*, 23(3), 237-274.

Kiesler, S., Zubrow, D., Moses, A. M., & Geller, V. (1985). Affect in computer-mediated communication: An experiment in synchronous terminal-to-terminal discussion. *Human-Computer Interaction*, 1(1), 77-104.

Kirkman, B. L., Rosen, B., Tesluk, P. E., & Gibson, C. B. (2004). The impact of team empowerment on virtual team performance: The moderating role of face-to-face interaction. *Academy of Management Journal*, 47(2), 175-192.

Kirton, M. J. (1989). A theory of cognitive style. *Adaptors and innovators: Styles of creativity and problem solving*, 1, 33.

Kirton, M. (1976). Adaptors and innovators: A description and measure. *Journal of applied psychology*, 61(5), 622.

Klitmøller, A., & Luring, J. (2013). When global virtual teams share knowledge: Media richness, cultural difference and language commonality. *Journal of World Business*, 48(3), 398-406.

Kurtzberg, T. R., & Amabile, T. M. (2001). From Guilford to creative synergy: Opening the black box of team-level creativity. *Creativity Research Journal*, 13(3-4), 285-294.

LeBreton, J. M., & Senter, J. L. (2008). Answers to 20 questions about interrater reliability and interrater agreement. *Organizational research methods*, 11(4), 815-852.

Leenders, R. T. A., Van Engelen, J. M., & Kratzer, J. (2003). Virtuality, communication, and new product team creativity: a social network perspective. *Journal of Engineering and Technology Management*, 20(1-2), 69-92.

Letaief, R., Favier, M., & Le Coat, F. (2006). Creativity and the creation process in global virtual teams: Case study of the intercultural virtual project. In *AIM Conference* (pp. 242-258).

Little, R. J. (1988). A test of missing completely at random for multivariate data with missing values. *Journal of the American Statistical Association*, 83(404), 1198-1202.

Lipnack, J., & Stamps, J. (1999). Virtual teams: The new way to work. *Strategy & Leadership*, 27(1), 14-19.

Lu, M., House, C. H., Watson-Manheim, M. B., & Matzkevich, T. (2005). Does Distance Matter?-Bridging the Discontinuities in Distributed Organizations. In *System Sciences, 2005. HICSS'05. Proceedings of the 38th Annual Hawaii International Conference on* (pp. 42a-42a). IEEE.

Lu, L., Zhou, F., & Leung, K. (2011). Effects of task and relationship conflicts on individual work behaviors. *International Journal of Conflict Management*, 22(2), 131-150.

Lynch, P., O'Toole, T., & Biemans, W. (2014). From conflict to crisis in collaborative NPD. *Journal of Business Research*, 67(6), 1145-1153.

Majchrzak, A., Rice, R. E., Malhotra, A., King, N., & Ba, S. (2000). Technology adaptation: The case of a computer-supported inter-organizational virtual team. *MIS quarterly*, 569-600.

Marks, M. A., Mathieu, J. E., & Zaccaro, S. J. (2001). A temporally based framework and taxonomy of team processes. *Academy of management review*, 26(3), 356-376.

- Markus, M. L. (1994). Electronic mail as the medium of managerial choice. *Organization science*, 5(4), 502-527.
- Martins, L. L., Gilson, L. L., & Maynard, M. T. (2004). Virtual teams: What do we know and where do we go from here?. *Journal of management*, 30(6), 805-835.
- Mathieu, J., Maynard, M. T., Rapp, T., & Gilson, L. (2008). Team effectiveness 1997-2007: A review of recent advancements and a glimpse into the future. *Journal of management*, 34(3), 410-476.
- Maznevski, M. L., & Chudoba, K. M. (2000). Bridging space over time: Global virtual team dynamics and effectiveness. *Organization science*, 11(5), 473-492.
- McGuire, T. W., Kiesler, S., & Siegel, J. (1987). Group and computer-mediated discussion effects in risk decision making. *Journal of personality and social psychology*, 52(5), 917.
- Milliken, F. J., Bartel, C. A., & Kurtzberg, T. R. (2003). Diversity and creativity in work groups. *Group creativity: Innovation through collaboration*, 32-62.
- Milliken, F. J., & Martins, L. L. (1996). Searching for common threads: Understanding the multiple effects of diversity in organizational groups. *Academy of management review*, 21(2), 402-433.
- Nagy, M. S. (2002). Using a single-item approach to measure facet job satisfaction. *Journal of occupational and organizational psychology*, 75(1), 77-86.
- Nakui, T., Paulus, P. B., & Van der Zee, K. I. (2006). Effects of diversity and attitude toward diverse groups on perception and performance. *Unpublished manuscript, University of Texas at Arlington*.
- Nemeth, C. J. (1986). Differential contributions of majority and minority influence. *Psychological review*, 93(1), 23.
- Nemiro, J. (2004). *Creativity in virtual teams: Key components for success* (Vol. 6). John Wiley & Sons.

- Ocker, R. J. (2005). Influences on creativity in asynchronous virtual teams: A qualitative analysis of experimental teams. *IEEE Transactions on Professional Communication*, 48(1), 22-39.
- Osborne, J. W., & Overbay, A. (2004). The power of outliers (and why researchers should always check for them). *Practical assessment, research & evaluation*, 9(6), 1-12.
- Pallant, J. (2013). *SPSS survival manual*. McGraw-Hill Education (UK).
- Paulus, P. (2009). *Fostering creativity in groups*. I. J. Zhou & C. E. Shalley (red). In *The Handbook of Organizational Creativity* (pp. 165 - 188). New York: Psychology Press.
- Pelled, L. H., Eisenhardt, K. M., & Xin, K. R. (1999). Exploring the black box: An analysis of work group diversity, conflict and performance. *Administrative science quarterly*, 44(1), 1-28.
- Purdy, J. M., Nye, P., & Balakrishnan, P. V. (2000). The impact of communication media on negotiation outcomes. *International Journal of Conflict Management*, 11(2), 162-187.
- Putnam, L. L. (1988). Communication and interpersonal conflict in organizations. *Management Communication Quarterly*, 1(3), 293-301.
- Rico, R., & Cohen, S. G. (2005). Effects of task interdependence and type of communication on performance in virtual teams. *Journal of Managerial Psychology*, 20(3/4), 261-274.
- Robins, R. W., Hendin, H. M., & Trzesniewski, K. H. (2001). Measuring global self-esteem: Construct validation of a single-item measure and the Rosenberg Self-Esteem Scale. *Personality and social psychology bulletin*, 27(2), 151-161.
- Salas, E., Cooke, N. J., & Rosen, M. A. (2008). On teams, teamwork, and team performance: Discoveries and developments. *Human factors*, 50(3), 540-547.
- Sallnäs, E. L. (2005). Effects of communication mode on social presence, virtual presence, and performance in collaborative virtual environments. *Presence: Teleoperators & Virtual Environments*, 14(4), 434-449.

Saunders, M., Lewis, P., & Thornhill, A. (2009). *Research Methods for Business Students* (5th edn).

Shachaf, P. (2008). Cultural diversity and information and communication technology impacts on global virtual teams: An exploratory study. *Information & Management*, 45(2), 131-142.

Shin, S. J., Kim, T. Y., Lee, J. Y., & Bian, L. (2012). Cognitive team diversity and individual team member creativity: A cross-level interaction. *Academy of Management Journal*, 55(1), 197-212.

Short, J., Williams, E., & Christie, B. (1976). *The social psychology of telecommunications*.

Simons, T. L., & Peterson, R. S. (2000). Task conflict and relationship conflict in top management teams: the pivotal role of intragroup trust. *Journal of applied psychology*, 85(1), 102-111.

Singh, J., & Fleming, L. (2010). Lone inventors as sources of breakthroughs: Myth or reality?. *Management science*, 56(1), 41-56.

Society for Human Resource Management (2012). *SHRM: Survey Findings: Virtual teams*. <https://www.shrm.org/hr-today/trends-and-forecasting/research-and-surveys/pages/virtualteams.aspx> [Accessed 17 Mai. 2018].

Stahl, G. K., Maznevski, M. L., Voigt, A., & Jonsen, K. (2010). Unraveling the effects of cultural diversity in teams: A meta-analysis of research on multicultural work groups. *Journal of international business studies*, 41(4), 690-709.

Straus, S. G., & McGrath, J. E. (1994). Does the medium matter? The interaction of task type and technology on group performance and member reactions. *Journal of applied psychology*, 79(1), 87.

Suh, K. S. (1999). Impact of communication medium on task performance and satisfaction: an examination of media-richness theory. *Information & Management*, 35(5), 295-312.

Tabachnick, B. G., & Fidell, L. S. (2007). *Using multivariate statistics*. Allyn & Bacon/Pearson Education.

Thatcher, S. M., & Brown, S. A. (2010). Individual creativity in teams: The importance of communication media mix. *Decision Support Systems*, 49(3), 290-300.

Ting-Toomey, S. (1982). Toward a theory of conflict and culture.

Townsend, A., DeMarie, S., & Hendrickson, A. (1998). Virtual teams: Technology and the workplace of the future. *Academy Of Management Perspectives*, 12(3), 17-29.

Uzzi, B., Mukherjee, S., Stringer, M., & Jones, B. (2013). Atypical combinations and scientific impact. *Science*, 342(6157), 468-472.

Weisband, S. P. (1992). Group discussion and first advocacy effects in computer-mediated and face-to-face decision making groups. *Organizational behavior and human decision processes*, 53(3), 352-380.

White, H. (1980). A heteroskedasticity-consistent covariance matrix estimator and a direct test for heteroskedasticity. *Econometrica: Journal of the Econometric Society*, 817-838.

Woehr, D. J., Loignon, A. C., Schmidt, P. B., Loughry, M. L., & Ohland, M. W. (2015). Justifying aggregation with consensus-based constructs: A review and examination of cutoff values for common aggregation indices. *Organizational Research Methods*, 18(4), 704-737.

Wuchty, S., Jones, B. F., & Uzzi, B. (2007). The increasing dominance of teams in production of knowledge. *Science*, 316(5827), 1036-1039.

X-Culture (n.d.). *For Instructors*. Retrieved from: <https://x-culture.org/for-instructors/> [Accessed 10 Mar. 2018].

X-Culture (n.d.). *For Students*. Retrieved from: <https://x-culture.org/for-students/> [Accessed 10 Mar. 2018].

X-Culture (n.d.). *For Professionals*. Retrieved from: <https://x-culture.org/for-professionals/#teachers> [Accessed 10 Mar. 2018].

Yong, K., Sauer, S. J., & Mannix, E. A. (2014). Conflict and creativity in interdisciplinary teams. *Small Group Research*, 45(3), 266-289.

Yoo, Y., & Alavi, M. (2001). Media and group cohesion: Relative influences on social presence, task participation, and group consensus. *MIS quarterly*, 371-390.

Zakaria, N., Amelinckx, A., & Wilemon, D. (2004). Working together apart? Building a knowledge-sharing culture for global virtual teams. *Creativity and innovation management*, 13(1), 15-29.

Zhang, Y., Fang, Y., Wei, K. K., & Chen, H. (2010). Exploring the role of psychological safety in promoting the intention to continue sharing knowledge in virtual communities. *International Journal of Information Management*, 30(5), 425-436.

8. Appendix

Appendix 3-1: Number of schools and participants by country

Table 3-3: Number of participants and schools in each country

Countries	Average age	Number of participants	Participants in percent	Number of schools	Average number of students per school
<i>USA</i>	23,62	1332,00	32,86%	42	31,71
<i>Colombia</i>	21,59	423,00	10,44%	7	60,43
<i>Malaysia</i>	22,36	292,00	7,20%	2	146,00
<i>Italy</i>	23,25	207,00	5,11%	6	34,50
<i>Brazil</i>	22,41	170,00	4,19%	5	34,00
<i>Mexico</i>	20,91	166,00	4,10%	5	33,20
<i>Taiwan</i>	22,46	165,00	4,07%	4	41,25
<i>India</i>	19,55	104,00	2,57%	4	26,00
<i>Canada</i>	22,83	99,00	2,44%	3	33,00
<i>Bhutan</i>	21,95	98,00	2,42%	1	98,00
<i>Peru</i>	22,74	90,00	2,22%	1	90,00
<i>Kenya</i>	27,92	60,00	1,48%	1	60,00
<i>Pakistan</i>	22	58,00	1,43%	1	58,00
<i>Russia</i>	21,22	58,00	1,43%	7	8,29
<i>Poland</i>	23,46	56,00	1,38%	1	56,00
<i>Ghana</i>	24,91	50,00	1,23%	1	50,00
<i>Indonesia</i>	21,3	49,00	1,21%	1	49,00
<i>Turkey</i>	22,2	49,00	1,21%	2	24,50
<i>Belgium</i>	21,91	47,00	1,16%	1	47,00
<i>Grenada</i>	23,95	44,00	1,09%	1	44,00
<i>Oman</i>	22,05	44,00	1,09%	1	44,00
<i>UAE</i>	19,84	42,00	1,04%	1	42,00
<i>Norway</i>	22,05	39,00	0,96%	2	19,50
<i>Uganda</i>	30,49	39,00	0,96%	3	13,00
<i>Kazakhstan</i>	23,83	33,00	0,81%	2	16,50
<i>China</i>	20,46	29,00	0,72%	2	14,50
<i>Netherlands</i>	22,96	27,00	0,67%	2	13,50
<i>Estonia</i>	21,74	26,00	0,64%	1	26,00
<i>UK</i>	23,33	26,00	0,64%	2	13,00
<i>Germany</i>	22,09	23,00	0,57%	1	23,00
<i>Switzerland</i>	22,95	22,00	0,54%	1	22,00
<i>Croatia</i>	22,89	20,00	0,49%	1	20,00
<i>Lithuania</i>	22,33	20,00	0,49%	2	10,00
<i>Austria</i>	24,83	13,00	0,32%	1	13,00
<i>Spain</i>	25,64	12,00	0,30%	3	4,00
<i>Jamaica</i>	22,67	7,00	0,17%	3	2,33
<i>Thailand</i>	23,6	6,00	0,15%	1	6,00
<i>Hungary</i>	30	3,00	0,07%	1	3,00
<i>Ukraine</i>	19,33	3,00	0,07%	1	3,00
<i>Romania</i>	24	1,00	0,02%	1	1,00
<i>Slovakia</i>	26	1	0,02%	1	1,00
Total	22,8	4053	100%	129	31,42

Appendix 3-2: Preacher and Hayes' mediation model number 4

Model 4

Conceptual Diagram

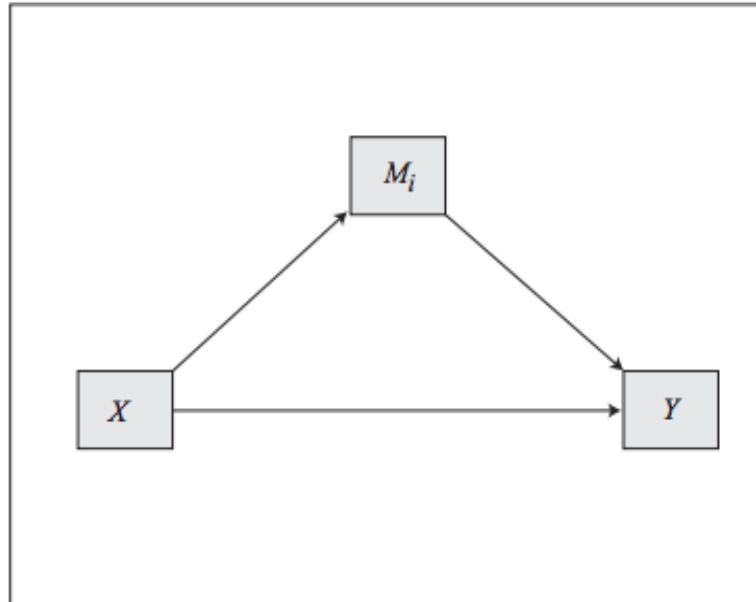

Statistical Diagram

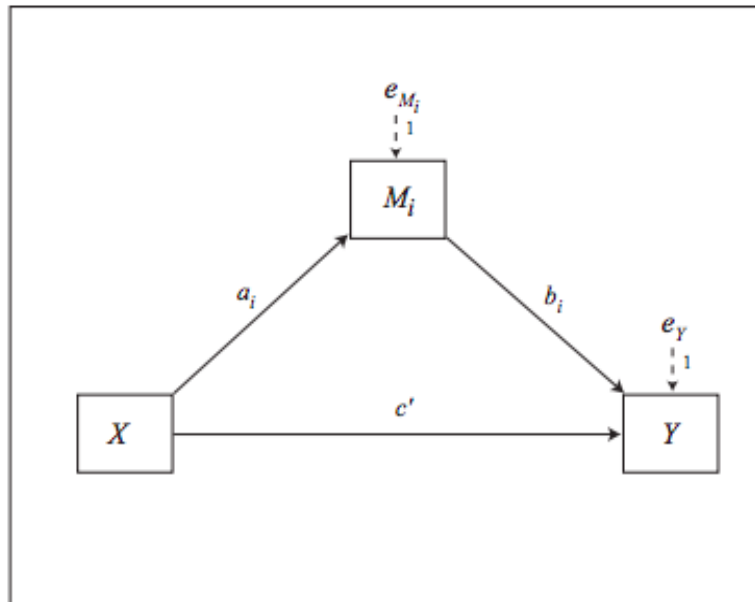

Indirect effect of X on Y through $M_i = a_i b_i$

Direct effect of X on $Y = c'$

*Model 4 allows up to 10 mediators operating in parallel

Appendix 4-1: Testing the conditions for multiple regression and mediation

Table 4-12: Normal distribution - Skewness & kurtosis

	Skewness (SE)	Kurtosis (SE)
Low richness com.	0,01 (0,09)	0,92 (0,18)
High richness com.	1,10 (0,09)	1,2 (0,18)
Interpersonal conflict	2,26 (0,09)	10,01 (0,18)
Process conflict	1,03 (0,09)	1,99 (0,18)
Task conflict	1,13 (0,09)	2,20 (0,18)
Creative output	-0,53 (0,09)	1,04 (0,18)

N = 770

Table 4-13: Multicollinearity - VIF and tolerance values

	Process variables		Creative Output	
	VIF	tol	VIF	tol
Low richness com.	0,907	1,103	0,907	1,103
High richness com.	0,907	1,103	0,907	1,103

process variables = Interpersonal conflict, task conflict, relationship conflict

N = 770

Table 4-14 Breusch-Pagan test values

	Testvalue
<i>Dependent variables</i>	
Interpersonal Conflict	60,358*
Task Conflict	9,253*
Process Conflict	2,411
Creative Output	6,142

Independent variables: low richness com., high richness com.

*Heterosekdasticity indicated by **

Table 4-15: Autocorrelation - Durbin Watson test values

	Int. Conflict	Task Conflict	Pro. Conflict	Creative output
Independent variables	2,07	2,06	2,01	0,06

Independent variables: Low richness com., High richness com.

Int. Conflict = Interpersonal Conflict, Pro. Conflict = Process Conflict

Table 4-16: Linarity - Creative output

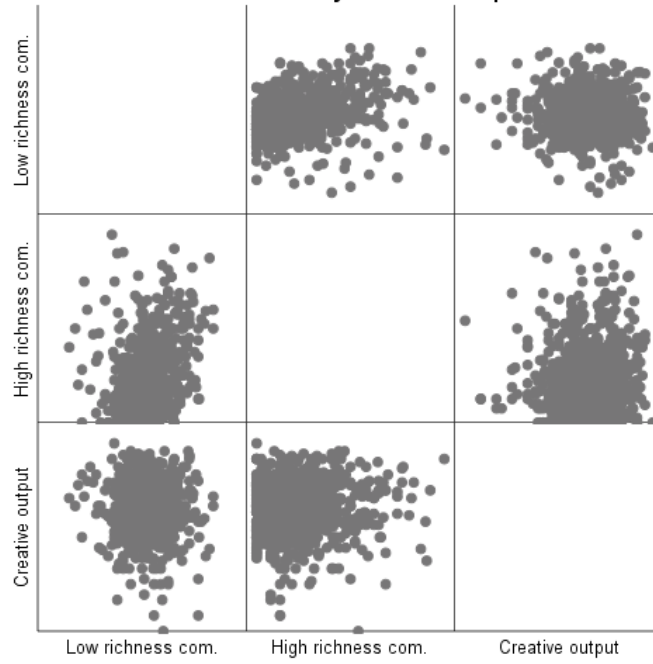

Table 4-17: Linarity - Relationship conflict

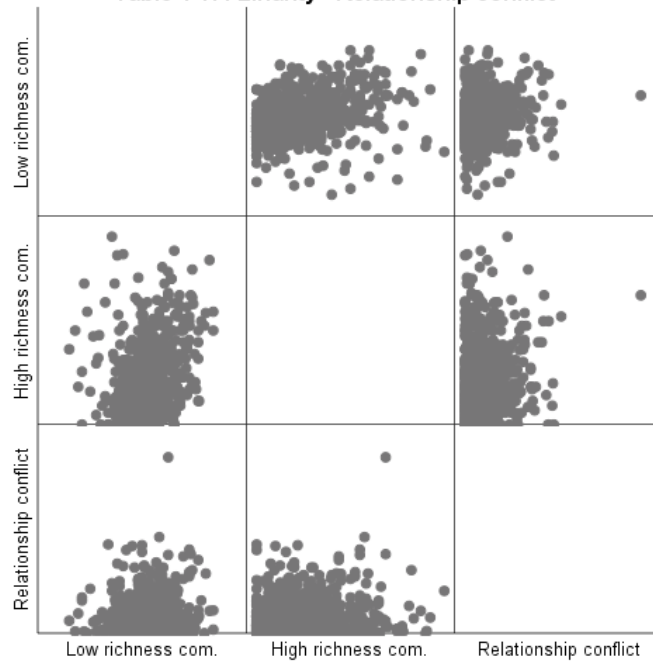

Table 4-18: Lilarity - Task conflict

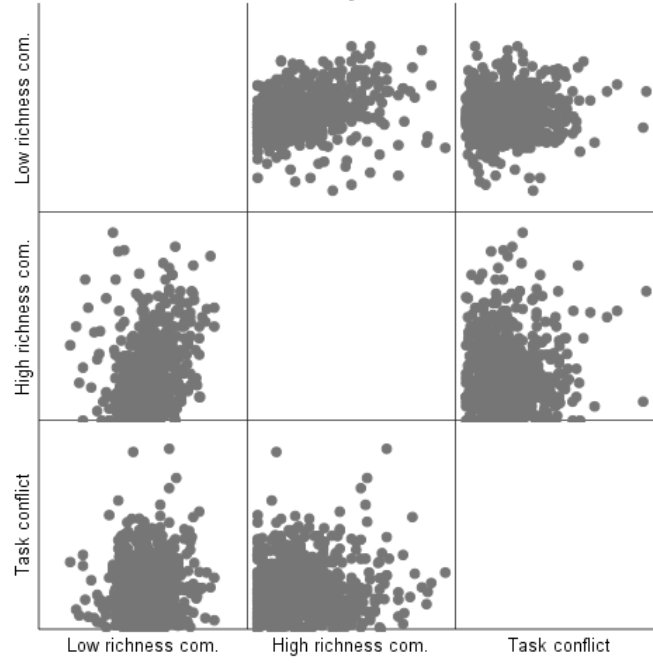
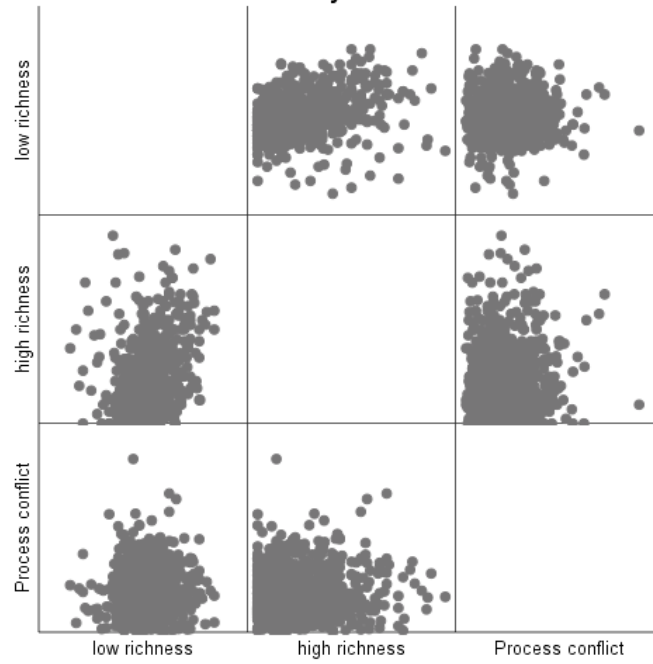

Table 4-19: Lilarity - Process conflict



Appendix 4-2: Additional analysis

Table 4-20: Confidence intervals: Mediation effects of low richness communication on perceived creative output

<i>Indirect effects</i>	Beta	95% Confidence interval
Total effect	-0,019	[-0.048 , 0.005]
Relationship conflict	0,003	[-0.012 , 0.024]
Task conflict	-0,015	[-0.052, 0.002]
Process conflict	-0,007	[-0.035 , 0.003]

N = 770

Table 4-21: Path coefficients: High richness communication on perceived creative output

	Beta	SE	t	p
<i>High richness communication on mediators, a-paths</i>				
Relationship conflict	0,06	0,03	2,025	0,043
Task conflict	0,0531	0,044	1,203	0,229
Process conflict	0,049	0,052	0,941	0,347
<i>Mediators on creative output, b-paths</i>				
Relationship conflict	0,028	0,073	0,391	0,696
Task conflict	-0,117	0,077	-1,525	0,128
Process conflict	-0,079	0,062	-1,285	0,203
<i>Total effect of High richness communication on perceived creative output, c-path</i>				
High richness communication	0,045	0,0436	1,035	0,301
<i>Direct effect of High richness communication on perceived creative output, c'-path</i>				
High richness communication	0,054	0,043	1,245	0,214

N = 770, controlling for the influence of low richness communication

Table 4-22: Confidence intervals: Mediation effects of high richness communication on perceived creative output

<i>Indirect effects</i>	Beta	95% Confidence interval
total effect	-0,008	[-0.031 , 0.009]
Relationship conflict	0,002	[-0.005 , 0.018]
Task conflict	-0,007	[-0.031 , 0.003]
Process conflict	-0,004	[-0.025 , 0.003]

N = 770

This master thesis examines the relationship between the media richness and frequency of communication on the creative output in global virtual teams. Two thirds of international organisations utilise virtual teams, to solve complex and creative tasks. Through a study of 770 student teams spread over 42 countries, we find that increased communication is not always conducive to creative output. Rather, we find that an increase in synchronous high richness communication positively relates to the creative output in global virtual teams, while increasing asynchronous low richness communication yields the opposite relationship. Our findings also suggest that increased low richness communication shares a stronger positive relationship with relationship conflict than does high richness communication. We therefore suggest that global virtual teams should place a greater emphasis on synchronous high richness communication rather than low richness communication when solving complex tasks.

SNF



Samfunns- og næringslivsforskning AS

Centre for Applied Research at NHH

Helleveien 30
NO-5045 Bergen
Norway

P +47 55 95 95 00
E snf@snf.no
W snf.no

Trykk: Allkopi Bergen