



The Effect of Time of Use in Norway

An empirical analysis of the effect of Time of Use tariff in combination with four different communication strategies on electricity consumption from a field experiment in Eastern Norway

Erlend Moen Fors & Sherif Ahmed

Supervisor: Lars Jonas Andersson

Master Thesis in Economics and Business Administration,
Business Analytics Major

NORWEGIAN SCHOOL OF ECONOMICS

This thesis was written as a part of the Master of Science in Economics and Business Administration at NHH. Please note that neither the institution nor the examiners are responsible – through the approval of this thesis – for the theories and methods used, or results and conclusions drawn in this work.

Acknowledgment

We would like to express our appreciation to our supervisor Jonas Andersson from the Department of Business and Management Science at Norwegian School of Economics for his valuable and constructive suggestions during the development of our work.

We would also like to thank Christopher Coello from Elvia for his technical assistance and for always showing sincere interest in our work.

Abstract

Norway has the world's second highest electricity consumption per capita (International Energy Agency, n.d.). Increased electrification of society services is expected to push peak consumption to higher levels than its current state. This will challenge the current grid capacity and might require upgrade investments. However, efficient usage of the current capacity might contribute to postponing these costly investments. One of the instruments to achieve this efficiency is designing a new grid tariff. Elvia, the biggest Norwegian distribution system operator is testing a new Time of Use tariff on a random sample of 4505 residential customers. Four strategies have been used to communicate the tariff. This thesis estimates the effect of the interaction of Time of Use tariff and the communication strategies, in comparison to a control group by using the Difference in Differences method. The results show that appealing only to the economic sense was not sufficient to reduce peak consumption, while environmental and social pressure focused messages have higher effect. Limitations and avenues for further research have been discussed.

Content

| | | |
|-----------|---|-----------|
| 1. | INTRODUCTION | 11 |
| 2. | BACKGROUND..... | 13 |
| 2.1 | THE ELECTRICAL GRID | 13 |
| 2.2 | THE NORWEGIAN ELECTRICITY SYSTEM..... | 14 |
| 2.2.1 | <i>Demand Side</i> | 14 |
| 2.2.2 | <i>Generation Side (Supply Side)</i> | 16 |
| 2.3 | POWER SYSTEM FLEXIBILITY..... | 17 |
| 2.3.1 | <i>Generation Side Flexibility</i> | 17 |
| 2.3.2 | <i>Demand Side Flexibility</i> | 18 |
| 2.4 | DEMAND RESPONSE AND TIME-OF-USE | 19 |
| 3. | LITERATURE REVIEW | 22 |
| 3.1 | RELEVANT EXPERIMENTS | 22 |
| 3.1.1 | <i>Pilot Study in Norway - Malvik Everk</i> | 22 |
| 3.1.2 | <i>DR in Residential Areas in the Netherlands Caused by Dynamic Pricing</i> | 23 |
| 3.1.3 | <i>Impact of TOU tariffs in Northern Italy</i> | 23 |
| 3.1.4 | <i>Introducing TOU in Sweden</i> | 24 |
| 3.1.5 | <i>The Effect of Information on TOU: An Irish Residential Study</i> | 24 |
| 3.2 | INTERVENTION STUDIES ON ENERGY CONSERVATION | 25 |
| 3.3 | CUSTOMER PERCEPTION..... | 27 |
| 3.4 | CONCLUSIONS FROM THE LITERATURE REVIEW | 28 |
| 4. | EXPERIMENTAL DESIGN | 30 |
| 4.1 | THE ELECTRICITY INVOICE | 31 |
| 4.2 | DESIGN | 32 |

| | | |
|-----------|--|-----------|
| 4.2.1 | <i>Sample Size</i> | 32 |
| 4.2.2 | <i>Participants</i> | 33 |
| 4.3 | TREATMENTS | 34 |
| 4.3.1 | <i>The Tariff Model</i> | 34 |
| 4.4 | COMMUNICATING TOU TO THE CUSTOMERS | 35 |
| 4.4.1 | <i>Neutral (INGEN)</i> | 36 |
| 4.4.2 | <i>Competitive (KONKURRANSE)</i> | 36 |
| 4.4.3 | <i>Smart Consumption (SMART)</i> | 36 |
| 4.4.4 | <i>Environment (MILJO)</i> | 37 |
| 4.5 | RESEARCH QUESTION..... | 37 |
| 5. | STATISITCAL ANALYSIS | 38 |
| 5.1 | DATA DESCRIPTION AND DATA QUALITY | 38 |
| 5.2 | DESCRIPTIVE ANALYSIS AND PRE EXPERIMENT ANALYSIS | 38 |
| 5.2.1 | <i>Differences between groups</i> | 40 |
| 5.3 | DIFFERENE-IN-DIFFERENCES..... | 42 |
| 5.3.1 | <i>Why use Difference-in-differences?</i> | 42 |
| 5.3.2 | <i>DID Regression</i> | 44 |
| 5.3.3 | <i>Assumptions</i> | 45 |
| 5.4 | HOW SHOULD THE RESULTS IN THE ANALYSIS BE INTERPRETED..... | 46 |
| 5.5 | MODELLING & RESULTS | 47 |
| 5.5.1 | <i>Model A: Dag Hours</i> | 47 |
| 5.5.2 | <i>Month vs Month</i> | 51 |
| 5.5.3 | <i>Model B: NATT Weekday</i> | 52 |
| 5.5.4 | <i>Model C: NATT Weekend</i> | 53 |

| | | |
|-----------|---|-----------|
| 5.5.5 | <i>Model D: Total</i> | 54 |
| 5.6 | SUMMARY OF THE RESULTS | 55 |
| 6. | DISCUSSION | 57 |
| 6.1 | INTERNAL VALIDITY | 57 |
| 6.2 | EXTERNAL VALIDITY | 59 |
| 6.3 | COMPARING THE RESULTS TO THE LITERATURE | 60 |
| 6.4 | PROBLEMS RELATED TO ELVIA'S PILOT PROJECT..... | 62 |
| 6.5 | CUSTOMER PERCEPTION - ETHICAL ASPECTS OF TOU..... | 62 |
| 6.6 | POSSIBLE EXPLANATIONS | 63 |
| 6.7 | LIMITATIONS AND FURTHER RESEARCH | 65 |
| 7. | CONCLUSION | 69 |
| | REFERENCES | 71 |
| | BIBLIOGRAPHY | 78 |
| | APPENDICES | 79 |

List of Figures

| | |
|---|----|
| Figure 2.1 - The Electrical Grid | 13 |
| Figure 2.2 - Maximum registered hourly energy usage in Norway from 1990 – 2018 | 16 |
| Figure 2.3 - Demand side flexibility mechanisms..... | 18 |
| Figure 2.4 - Hierarchical model illustrating TOU’s role in Demand Side Management. | 20 |
| Figure 2.5 – Price Driven Demand Response | 21 |
| Figure 4.1 - EU Households electricity bills by components..... | 32 |
| Figure 4.2 - An overview of the groups used in this study | 36 |
| Figure 5.1 - Boxplot of the Groups in the Study..... | 39 |
| Figure 5.2 - Illustration of the DID concept..... | 44 |
| Figure 5.3 - The Registered Average Hourly Weekday Consumption | 45 |
| Figure 5.4 - Residual plot..... | 51 |

List of Tables

| | |
|---|----|
| Table 1 - Attrition Rate. | 33 |
| Table 2 - TOU Tariffs Implemented by Elvia.. | 34 |
| Table 3 - Network Tariffs for the Control Group..... | 34 |
| Table 4 - Daily Consumption Prior to Experiment. | 39 |
| Table 5 - Differences Between Groups Prior to the Experiment | 41 |
| Table 6 - Compliance Matrix. | 46 |
| Table 7 - The Regression Estimates of Model A: Dag..... | 50 |
| Table 8 - The Causal Effect for Each Month | 52 |
| Table 9 - Estimated Causal Effect During Natt Hours (Weekday) | 53 |
| Table 10 - Estimated Causal Effect on Weekends. | 54 |
| Table 11 - Aggregated daily Consumption Across the Whole Experiment. | 55 |
| Table 12 - Summary of The Results..... | 56 |

Acronyms

ATE – Average Treatment Effect

CPP – Critical Peak Pricing

EE – Energy Efficiency

DID – Difference-in-Differences

DR – Demand Response

DSO – Distribution System Operator

IHD – In-home-display

ITT – Intention-to-Treat effect

LATE – Local Average Treatment Effect

OLS – Ordinary Least Square

PDDR – Price Driven Demand Response

PV – Photovoltaic

RTP – Real-Time Pricing

TOU – Time of Use

TOT – Treatment on the Treated effect

TSO – Transmission System Operator

1. Introduction

Green policies and technological developments are pushing the power system through drastic changes by influencing how we produce and consume electricity.

The power grid transmits electricity from the production sites to the end users. The share of non-dispatchable energy resources such as photovoltaic and wind, is expected to increase as a part of the energy production mix. Meanwhile, the electrification of many societies' sectors makes us consume more electricity with a trend that is expected to rise.

The supply and demand of electricity within a power system must stay in balance (Energy facts Norway, 2019). The energy output from non-dispatchable resources is intermittent and uncertain. With the increasing share of such resources, system uncertainty is increasing and keeping supply and demand in balance is becoming harder. This imbalance between supply and demand can disturb the service quality and security provided by the power grids (Statnett, 2018). On the other hand, it is not possible to transport electricity to the end users more than the designed capacity of the grid.

Typically, the electric grid is designed to be able to handle both expected short- and long-term variability in demand and supply and to handle projected peaks in electricity demand (Uddin et al., 2018). Maintenance and upgrading the grid capacity with a goal of accommodating the increasing share of variable renewable power resources and handling expected maximum peak time is costly and economically inefficient, due to the fact that the grid is fully utilized only a few hours per year. These costs are financed mainly by the users of the grid. In 2020, the estimated distribution net costs were 13.9 billion NOK in Norway (Eriksen & Mook, 2020). Therefore, optimal use of the grid means less costs for users since grid reinforcements can be postponed. This puts pressure on grid operators to implement flexibility in the demand side in order to optimize the usage of the existing capacity of the grid instead of upgrading it.

One of the tools for activating demand side flexibility, is by using a price signal via the grid tariff to affect users' consumption patterns. The current structure of grid tariff consists of a fixed part which is paid regardless of how much electricity a user consumes, and a variable part which relates to the electricity consumption; however, this variable part does not reflect

the time of use. Meaning that if two customers use the same amount of electricity but one uses it at a time of peak load and the other uses it at a time of off-peak load, they will pay the same amount of money. Therefore, the current structure does not reflect the grid capacity investment and maintenance costs needed for each customer's pattern of use and does not incentivize customers for optimal use of the grid capacity.

Elvia is the biggest Distribution System Operator (DSO) in Norway. Its grid covers an area of almost 50 000 km² and delivers electricity to around 900 000 households. Elvia is considering changing the structure of the existing grid tariff. To do this, Elvia designed a field experimental study to test the effect of a Time of Use (TOU) tariff and different communication strategies to communicate this new tariff to the end users.

The aim of this thesis is to measure the effect of the suggested new tariff and of four strategies to communicate the change to the customers. This thesis will add to the existing literature by presenting results from a completely new dataset, which has larger sample size compared to previous studies, and investigating the effect of different communication strategies. Some of the studies presented in the literature review struggle with biased samples, which is dealt with in this study through random sampling and random assignment of treatment. Also, as most of the literature we review is approximately 10 years old as this point, the results from Elvia's pilot should better reflect the effect of TOU and communication strategies in the current market, which is rapidly changing due to the increasing number of EV in Norway and the introduction of smart appliances.

The thesis structure is as follows: The second chapter aims to give the reader the necessary background in electricity systems to understand the root of the problem that TOU is trying to solve with a focus on the structure of the Norwegian system. The chapter gives an overview of the available strategies that can be a solution for the existing issues in the Norwegian power system. In chapter 3, we review the previous studies that document previous implementations of TOU tariff and interventions on how to reduce energy usage. In chapters 4, we describe Elvia's experiment design. Chapter 5, we elaborate on our choice of statistical technique, and illustrate the statistical results. In chapter 6, we discuss the results in the light of internal and external validity and the literature. Furthermore, we discuss the limitation of the experiment and the avenues for future research. Finally, in chapter 7, we come with the concluding remarks.

2. Background

2.1 The Electrical Grid

The electric grid is a network that works for delivering electricity from the production (supply) sides to the demand/load (consumption) sides (See Figure 2.1). The grid can be classified into two types: The transmission grid and the distribution grid. The transmission grid typically covers a large geographical area and is characterized by high voltage levels to transfer the electricity from the production sides to substations, whereas the distribution grid is characterized by low voltage levels to transfer the electricity from substation to the end consumer where the purpose of consumption might be industrial, commercial, or residential (Blume, 2016).

In Norway, most customers have smart meters that measure power flow from and to the grid. The hourly meter readings are sent throughout the day to the DSO. Transmission grids are managed by a Transmission System Operator (TSO), which is Statnett in Norway, while the distribution grid is managed by a DSO, e.g., Elvia.

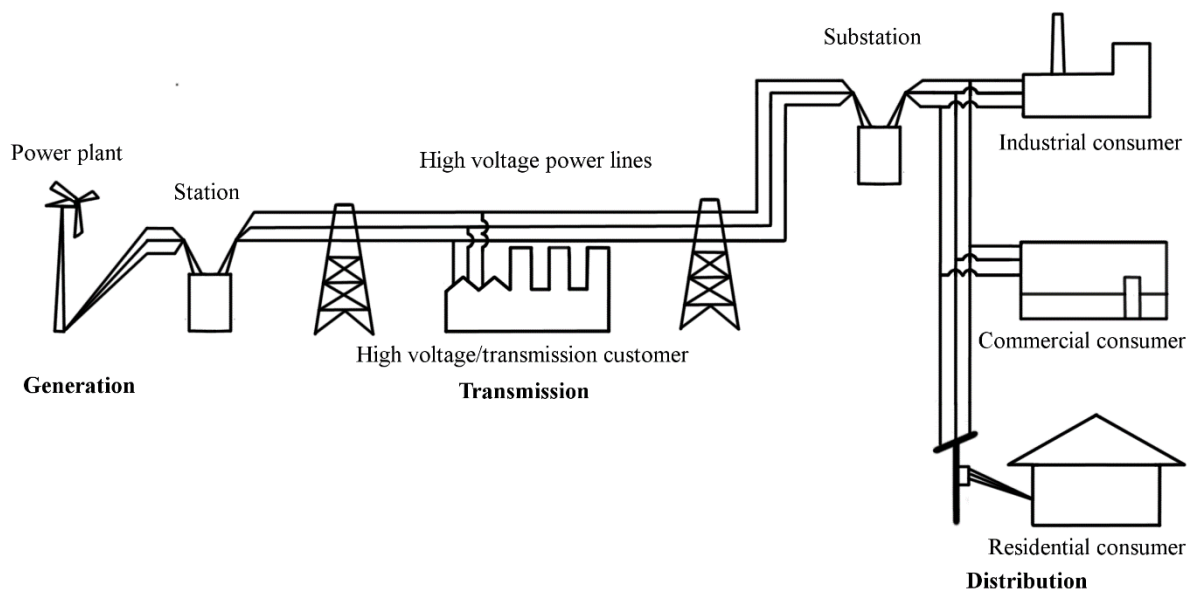

Figure 2.1 - The Electrical Grid. Inspired by Fig. 1.1 in Blume (2016): From left to right: Generation side, Transmission, Distribution and Demand side.

A basic characteristic of the electricity system is that supply must always match demand. Imbalances between supply and load can degrade system frequency stability. TSOs are responsible for keeping system frequency at a specific level within allowed variations (Haug, 2019). Extreme frequency variation that exceeds the allowed limits can lead to lifetime degradation or failure of grid's equipment. TSOs manage imbalances by enhancing system inertia. A power system that has high inertia is the one that is resilient and capable of continuing provision of quality service despite sudden disturbances (Statnett, 2018). TSOs stabilize system frequency by controlling the supply side. This is done by ramping up or down the electric generation as a response to frequency changes (Drax, 2021). Renewable energy resources like wind and solar lack inertia as they are difficult to control in comparison to traditional resources.

Imbalances between generation and load, in parallel with increased load levels impose challenges to DSOs as well. These challenges can be materialized into two main problems: voltage and congestion (Huang et al., 2016). The former refers to voltage levels exceeding its variation limits due to system imbalance, the latter refers to the situations where the existing physical grid capabilities are unable to accommodate the required load (Khani et al 2018). This can result in violations of system components' thermal limits. The traditional solution to these problems is reinforcing grid capacity by, for example, adding parallel lines and transformers.

2.2 The Norwegian Electricity System

In this section we will discuss the current structure of the demand and supply side of the Norwegian electricity system. The section highlights the vulnerabilities of the current structure and how it is expected to be developed in the future, and why it is important to try to change the behavior of residential consumers through TOU.

2.2.1 Demand Side

Norway is ranked as second in world in terms of electricity consumption per capita (International Energy Agency, n.d.). While the Norwegian production capacity can respond to such high demand, the grid must be dimensioned to transmit it. Problems arise when there is a very high electric load within short periods like hours or even minutes. Peak load is the

highest electrical power demand that has occurred over a specified time period (Gönen, 2008). Reducing peak load is important for reasons such as:

- Cost reduction

Generally, the power grid is designed to meet the maximum projected peak. Since peaks occur occasionally, it is not feasible economically to design the grid to accommodate higher than the usual needed capacity. Therefore, peak shaving will ensure that transmission and distribution systems are used efficiently. This will result in postponing system upgrading investment and extend the system's components life span. (Yan et al., 2014).

- System efficiency:

To meet peak load, supply current needs to be increased. However, as the current flowing through transmission lines increases, the power loss increases at a nonlinear rate.

Power loss can be estimated as follows (Ha et al., 2014):

$$PowerLoss = I^2 \times R$$

Where I is the current and R is the ohmic resistance of the lines.

Increasing the supply current will reduce the system efficiency, as power loss is proportionally related to the square of the current. Therefore, reducing peak demand would reduce system loss and improve the system efficiency (Kalkhambkar et al, 2016).

Until the time of writing this line, the maximum peak in Norway was on 12 February 2021 between 09:00 and 10:00 (Lund, 2021). It has a recorded consumption of 25 230 MWh (Statnett, 2021). In 1990 the maximum peak was 18 420 MWh (The Norwegian Water Resources and Energy Directorate, 2019). That constitutes a 37% increase. Figure 2.2 shows the upward trend in maximum hourly energy usage in Norway.

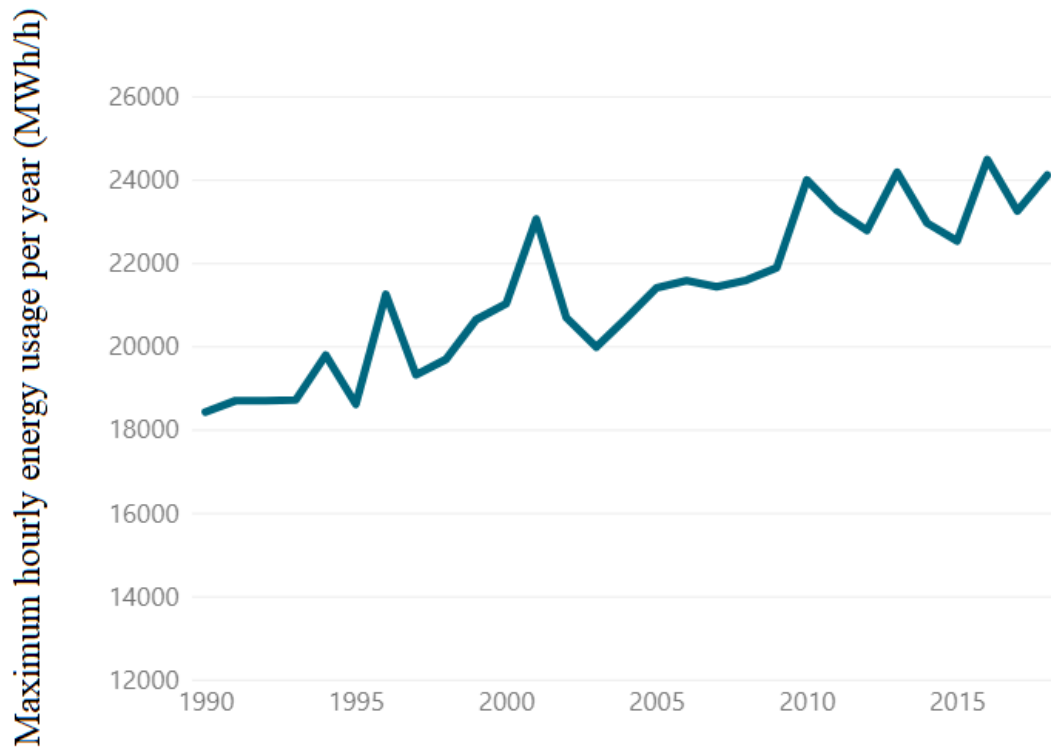

Figure 2.2 - Maximum registered hourly electricity peak in Norway from 1990 – 2018. Retrieved from *The Norwegian Water Resources and Energy Directorate (2019)*.

2.2.2 Generation Side (Supply Side)

The Norwegian energy mix consists of 89% hydropower, 8% wind turbines and 3% other resources such as gas and solar based production (The Norwegian Water Resources and Energy Directorate, 2021b). Generally, the ease of integration of renewable energy resources into the power grid depends mainly on three factors: dispatchability, predictability, and the storage capacity factor (Skar et al., 2018). Dispatchability refers to generators' theoretical ability to adjust their power output according to an order based on market needs. Different power generators vary in the time needed for adjusting their output. Predictability refers to the ability to predict the production output of a power plant ahead on time. Storage capacity refers to the available technology of storing energy for later use. These factors can contribute to supporting system balance by adjusting the production output according to the demand needs.

Hydropower based production can be regulated up and down. This implies that the large production capacity of Norwegian dispatchable hydropower resources can provide the supply

mix with flexibility (Energy facts Norway, 2021). On the other hand, integration of wind power resources can introduce challenges to system operators due to unpredictable and variable nature of it (Ahmed et al., 2020). Same applies for solar based systems, as its dependency on weather conditions makes the power output intermittent and difficult to predict (Yahyaoui, 2018). The share of solar power that was produced in 2020 in Norway is less than 1% of the total electricity production, but the installations of new systems are growing at an exponential rate (The Norwegian Water Resources and Energy Directorate, 2021a).

In conclusion, the current Norwegian supply mix is flexible enough to respond to changes in demand due to the high share of hydropower dispatchable resources. Nevertheless, increased share of non- dispatchable resources such as wind and solar based systems in the future can make the function of maintaining the system balance more challenging. On the demand side, peak loads strain the existing grid capacity. Upgrading the grid for handling peak electricity consumption is very costly and could be economically inefficient. This requires finding ways of exploiting existing flexibility in the system to reduce the costs that results from system imbalance and peak loads.

2.3 Power System Flexibility

A resilient electric grid system will have the flexibility to be able to handle problems that arise from power imbalance and peak consumption. In the next section, sources of flexibility in the production and demand side are going to be discussed.

Flexibility can be defined as *“the ability of a power system to cope with variability and uncertainty in both generation and demand, while maintaining a satisfactory level of reliability at a reasonable cost, over different time horizons”* (Ma et al., 2013, p. 1). From this definition, there are two sources of flexibility, which are the generation and demand side.

2.3.1 Generation Side Flexibility

Generation side flexibility can be achieved by controlling the amount of production from the power plants and/or providing energy storage systems. However, the amount of flexibility that the generation side can provide is dependent on some characteristics such as the production ramp up/down rate, startup/shut down capability, and generation range (Alizadeh et al., 2016).

2.3.2 Demand Side Flexibility

To alleviate system instabilities led by increasing electricity demand and uncertain renewable resources, demand side management activities are implemented in order to change the load profile of consumers. The load profile describes the variation in customers' electrical load versus a time dimension which could be daily or seasonal.

Flexibility at the consumer side can be manifested into six mechanisms (See Figure 2.3). The first is peak clipping which refers to the process of reducing the consumption at specific periods without shifting it. The second is valley filling which increases the electric consumption at certain periods. The third is load shifting which means the process of moving electricity consumption from one time period to another. The fourth is load reduction that refers to reducing the total load and the opposite strategy is load growth that increases total demand. Finally, flexible load shape when demand is affected only when it is necessary instead of permanent basis (Gellings, 2017).

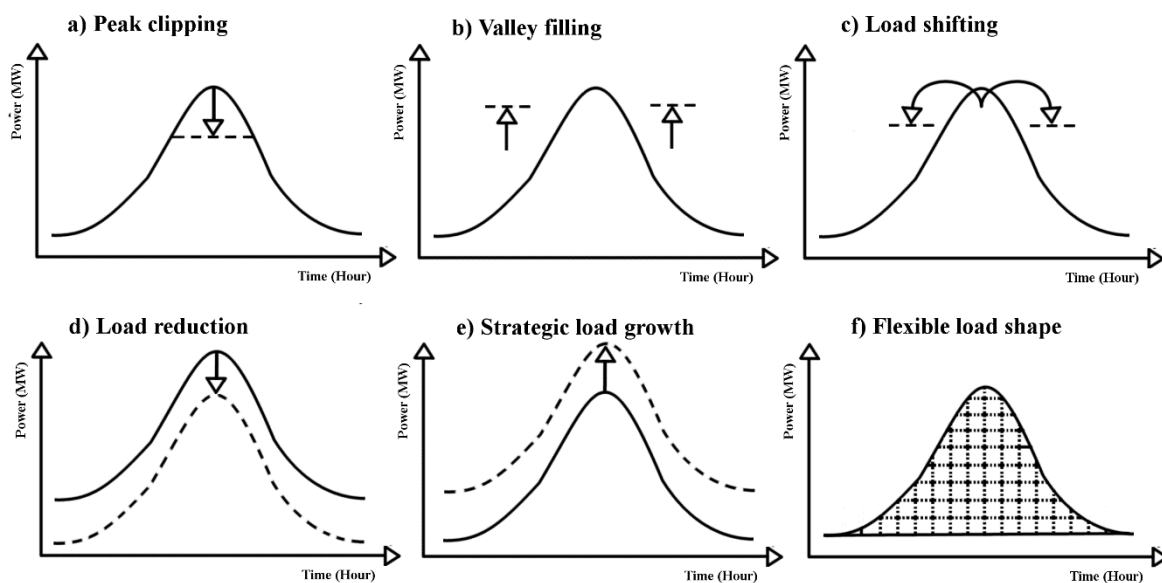

Figure 2.3 - Demand side flexibility mechanisms. Inspired by Figure 5 in Jabir (2018). From top left to bottom right: a) Peak clipping, b) valley filling, c) load shifting, d) load reduction, e) strategic load growth, f) flexible load shape.

2.4 Demand Response and Time-of-Use

Demand side management is generally split into two main fields: Energy efficiency (EE) and demand response (DR). EE aims to accomplish the same energy dependent function but by using less energy. It is mostly a long-term implementation. Usually, EE actions are implemented during the construction of a building and require preliminary investments (Alasseri et al., 2017). Two examples are insulation and switching over to LED lights.

However, the relevant approach for this thesis is DR. It is defined as:

Changes in electric use by demand-side resources from their normal consumption patterns in response to changes in the price of electricity, or to incentive payments designed to induce lower electricity use at times of high wholesale market prices or when system reliability is jeopardized. (Federal Energy Regulatory Commission, 2020).

According to Yan et al. (2018), DR can be split into two categories: price-driven demand response (PDDR) and “incentive or event-driven demand response”. The latter include direct load control, which let the DSO buy flexibility provided by the customers based on market mechanism or a contract (Kefayati & Baldick, 2011). For example, in case of low load, and high supply, the DSO can activate electric car charging at the customer side. PDDR presents consumers with time dependent energy rates. The goal is to shift user’s consumption from high priced peak load hours to lower priced off-peak hours. PDDR can be divided further into Time-of-Use (TOU), Critical Peak Pricing (CPP) and Real-Time Pricing (RTP) program (See Figure 2.4).

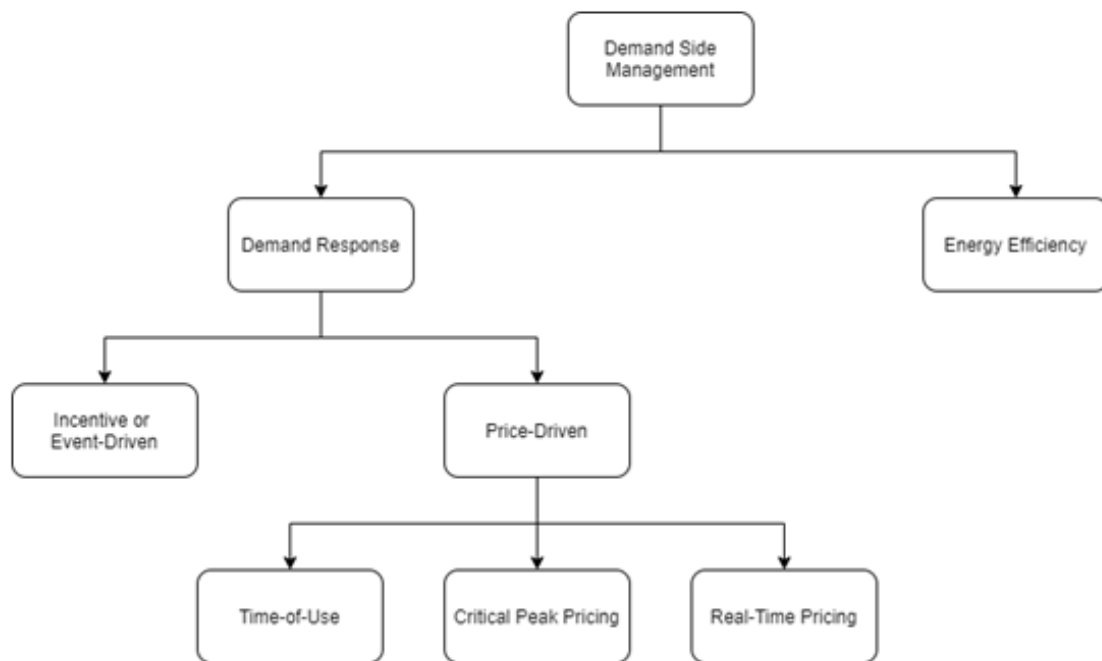

Figure 2.4 - Hierarchical model illustrating TOU's role in Demand Side Management.

TOU uses static prices that are determined in advance. The prices usually last across several hours. A simple example would be dividing the TOU tariff into two blocks: night prices and day prices, as this can mirror the load peak hours (IRENA, 2019). It is also possible to divide the day into smaller parts, for instance high prices during morning and evenings, while lower prices during the off-peak hours in the middle of the day. Seasonality can also play a factor when setting TOU prices, such as higher prices during the winter and lower prices during the summer. Holidays can also be a component.

In contrast to the TOU model, which uses static prices for each season, CPP is event driven and implements high prices during severely constrained periods in scenarios such as extremely cold winters/warm summers. Like in the TOU model, consumers will have an incentive to either reduce their energy usage during these peaks or shift consumption to off-peak periods. In contrast to TOU, it is not a daily demand response strategy, as serious system constraints do not occur daily. Because CPP is event driven, it is not a great tool to reduce daily energy consumption or cut energy costs. However, it can (and in certain cases do) complement other PDDR models, such as TOU.

Traditionally, RTP adapts its prices according to the power system balance or electricity whole-price market, however in the DSO's perspective a better measurement would be to set the prices by how much of the grid capacity is expected to be used. There have been limited attempts to research the effect of dynamic pricing among residential households, as participants will have problems to manually respond accordingly. Hence, it is not yet practical to implement RTP. Figure 2.5 illustrates the basic concept of TOU, CPP and RTP.

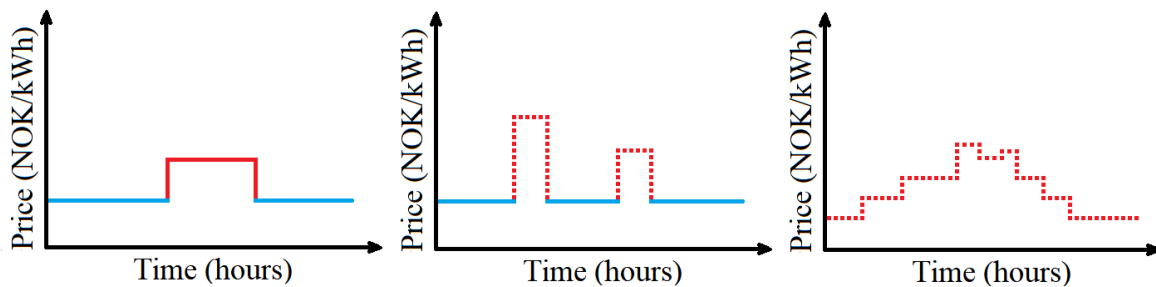

Figure 2.5 – Price Driven Demand Response. Inspired by Fig. 2 in Yan et al. (2018): From left to right: TOU, CPP and RTP.

3. Literature Review

In this chapter we will review some of the literature that we find most relevant to Elvia's pilot study. We will start by presenting similar pilot studies, which all use TOU except one study that use dynamic pricing. Next, we will review studies which use non-monetary interventions that can be used to complement TOU tariffs. Thirdly, we discuss how Norwegian consumers perceive TOU.

3.1 Relevant Experiments

3.1.1 Pilot Study in Norway - Malvik Everk

In the paper by Sæle & Grande (2011), the authors evaluate the effect of TOU on Norwegian households. The article describes defined peak hours that correlate to both high spot prices and high load. Hence, consumers have a total price signal that is a combination of the potential high spot prices during peak hours and a high network tariff cost. The treatment group consists of 40 households in the same geographical area, and they have an above average interest in electricity consumption. The peak hour price is set to 7.88 Eurocents/kWh/h in 2010 currency.

The authors explain that through the experiment, the DSO held two information meetings where the customers were notified about features relevant to the pilot study such as price signals, load control and peak hours. Furthermore, the participants were informed about potential variations in demand and the positive aspects of DR. The DSO's customers had access to a website that showed their network cost with TOU compared to the conventional network tariff.

The study shows that TOU successfully shift load from the morning peak periods, and the demand response is even greater for customers with high powered electric boilers used for water heating. By generalizing the results for all Norwegian households, they anticipated a DR of 1000 MWh/h from Norwegian households in 2010, which was approximately 4.2% of the registered peak demand on January 6th, 2010. The customers end up benefiting economically.

3.1.2 DR in Residential Areas in the Netherlands Caused by Dynamic Pricing

Klaassen et al. (2016) assess a pilot study involving two treatment groups in a newly developed residential area in the Netherlands in addition to a control group. The treatment groups involve 77 and 111 households. As the participants live in the same residential area, the groups are not randomized, which might give biased results. The houses in the area are all connected to PV panels and a district heating system. This is an interesting addition to the study by Sæle & Grande (2011), as it is possible to assess how effective DR is on prosumers.

In contrast to the pilot study in Norway, which uses high and low prices depending on whether it is during peak times or not, this study uses three prices. The customers are presented with a dynamic tariff that is communicated a day in advance through a home energy management system. They find a 31% significant decrease in load during the evening periods by using a two-sample t-test. The load shifts primarily to midday (20% increase), when PV generation is at its highest and the dynamic tariff is low.

The most common appliances used for load shifts are washing machines, tumble dryers and dishwashers. Other kitchen appliances, charging appliances and entertainment are not commonly used to shift load. Klaassen et al. (2016) classify appliances into time-critical, such cooking appliances, and non-time-critical such as washing machines. They conclude that peak load reduction is not influenced further by having a higher peak price, as the remaining evening peak load is mainly due to strongly time-critical appliances. Hence, complicated pricing schemes are not needed, and may confuse the customer. This should be considered when designing TOU tariffs.

3.1.3 Impact of TOU tariffs in Northern Italy

Torriti (2012) discusses electricity demand and peak shifting in 1446 residential households in Northern Italy. The TOU tariffs implemented give the households a lower electricity bill, if more than 66 % of their consumption is during low tariff hours.

The author finds that the consumption during both summer and winter increases on average by 13.7% with TOU. Even though consumption on average goes up, the morning peak shifts approximately one hour earlier. Also, the height and spikiness of the peak diminishes due to

TOU. The consumers seem to ignore the TOU tariff in the evenings as the evening peak is still present. According to this study, the TOU's ability to achieve DR is questionable as a majority of the substations face a higher electricity demand.

According to Torriti, the lack of load reduction may be an indication of the inflexible nature of certain activities, which are determined by the timing of human behavior rather than price. He questions the usefulness of TOU because it fails to reduce the peak loads and suggests investing into alternative programs such as real time pricing. He also points out that the information to the customers about TOU was lackluster.

3.1.4 Introducing TOU in Sweden

Bartusch et al (2011) completed a study in collaboration with a DSO in Central-Sweden to investigate Swedish households' response to a TOU tariff. The customers of the DSO without TOU have network tariffs with a high variable price and without any fixed tariff component. The treatment group which consists of 500 customers is introduced to TOU where the fee for using electricity during off peak hours is zero. The peak hour ratings are determined by fuse size and by the average of the 5 highest meter readings during peak hours. The defined peak hours are between 07:00 - 19:00. The rates are higher during winter compared to summer. The analysis consists of the one-year period prior to the TOU implementation and the two years following.

The Swedish electricity market is similar to the Norwegian, as both countries experience cold and dark winters, which results in energy consumption for heating and light sources. The authors find that total consumption is reduced by 11.1% the first year and 14.2% the second year. Furthermore, consumption shifts from peak hours to off-peak hours by approximately 1%. Most households experience lower expenses with TOU.

3.1.5 The Effect of Information on TOU: An Irish Residential Study

Pon (2017) argues that increased information from in-home display (IHD) may let consumers learn how their energy habits influence their bill. This can promote energy conservation behavior. In his study, Pon looks into how real time usage information and more often billing practices affect residential electricity consumption in a TOU setting. The treatment groups are as follows: Firstly, households with bi-monthly billing + energy reports. Secondly, households

with monthly billing + energy reports. Thirdly, households with IHD + bi-monthly billing + energy reports. The energy reports include details about the households' electricity usage and tips on how to reduce energy consumption. The control group receives bi-monthly billing and does not have energy reports and TOU. The treatment group consists of 2400 participants.

The households with TOU pricing and bi-monthly bills reduce their peak usage by 4.9%. Monthly billing results in an average reduction up to 5.5%. Households with IHD reduce their consumption up to 8.9%. Pon argues that the results indicate that if households have more access to information concerning their consumption, they will proportionally reduce their consumption. He states that "energy bills and reports may act as reminders for households to be more aware of their usage and conserve energy" (Pon, 2017, p. 68). More frequent billing and energy reports will thus remind the users to conserve energy during peak hours.

The households with an IHD and bi-monthly billing initially decreased their peak consumption more than the treatment groups that did not have IHD. These reductions would however start declining until the effects were similar to those with monthly billing and without IHD. This suggests that the effects of IHD are not permanent and will slowly fade away.

This study makes it clear that giving the households information- and reminders about their energy usage is important to achieve reduced load during peak hours. Thus, TOU tariffs need to be implemented in combination with increased information to have optimal effect.

3.2 Intervention Studies on Energy Conservation

Abrahamse et al (2005) reviewed various published articles within social- and environmental psychology. The goal is to evaluate the effectiveness of interventions with the intention to persuade households to reduce their energy use. These articles do not focus on load shift, but rather on a general reduction. However, the strategies implemented may still be relevant to achieve both load shift and to reduce consumption during high peak hours. In this section we present the most relevant interventions.

The interventions can broadly be categorized as either antecedent interventions or consequence interventions. Antecedent interventions are assumed to impact the consumer before behavior performances take place. An example is that providing information on how to reduce energy consumption may reduce consumption due to attained knowledge. The other

category is known as consequence interventions. These strategies assume that encouraging or discouraging consequences impact consumers' behavior. For instance, positive feedback can let the consumer see that he or she is able to reduce consumption successfully, which can motivate this behavior further. While an increase in energy consumption will be less appealing if there are negative consequences.

Goal setting is a form of antecedent intervention which involves introducing a household to a reference point, for instance reducing energy by 10%. It is advantageous if goal setting is combined with other interventions, such as feedback, to let households know how they are doing regarding the goal. An example of how this can be accomplished is by applying what McCalley & Midden (2002) did in a laboratory setting. They introduced goal setting and feedback to a single energy-related behavior, which was doing laundry. Participants that were given a goal in addition to feedback saved more energy per wash compared to those who just received feedback. A tough goal, like 20%, gives higher consumption reduction (15.1%) compared to an easily optionable goal like 2%, which shows almost no effect (Becker, 1978).

Information is a widely used intervention strategy that aims to encourage reduction in energy consumption. It can be broad information about energy-related problems, such as grid capacity, or more detailed information like methods on how to save energy. A workshop is an example of information intervention. Geller (1981) performed a study to assess how successful workshops are. The attendees also received a booklet that had information on how to reduce energy consumption. This is closely related to the information meetings performed by Malvik Everk in Sæle & Grande's study (2011). However, Geller (1981) did not find any behavioral changes regarding energy use. Mass media campaign can also be used to increase information about energy reduction to consumers. Staats et al. (1996) finds that mass media campaigns give a slight increase in knowledge, but no evidence of reduced energy usage.

Feedback is a commonly used consequence intervention that gives households information about their energy use. It can be divided into the frequency of the feedback. Abrahamse et al. (2005) divides feedback into continuous feedback, daily feedback, weekly/monthly feedback, and comparative feedback.

Continuous feedback may be given with the help of a monitor, such as an IHD, that shows households their energy consumption. Monthly feedback can also be given through the electricity bill. Heberlein & Warriner (1983) did a study focusing on the difference between

high peak and low peak hours, in which the latter had a lower rate. The customers received feedback via their electricity bill on how much kWh they consumed during high peak hours and off-peak hours. The results show that higher price disparities increase load shifts, however commitment and knowledge have greater impact.

Comparative feedback is the assumption that feedback about the household's relative consumption compared to others can help reduce energy use. This can lead to a sense of competition and social pressure which can be an effective way to achieve load shifts. Ayres et al. (2009) analyze the effect from the SMUD experiment, where the treatment group receives energy reports with 4 personalized elements. (1) A bar graph comparing their own consumption in the current period against similar neighbors and more efficient neighbors. (2) The same comparison, but over the last 12 months. (3) A segment that compares the consumption of the household in the months of the current year to the months of the year before. (4) Energy saving advice based on the household's consumption pattern. They find this intervention results in a 2.1% decrease in consumption, which does not diminish over the 12 months the experiment is active.

Petkov et al. (2011) dive into the effectiveness of social comparison by introducing an application that lets users use 5 features such as live data, history, neighbors, challenge and ranking. They authors find that peers are appropriate for comparison for motivating competition, while others are great for benchmarking.

3.3 Customer perception

A potential problem with implementing a TOU tariff model is the risk of having customers feeling repugnant by higher prices during their preferred time of consumption. In 2015, The Norwegian Water Resources and Energy Directorate asked Trøndelag Forskning og Utvikling to perform a consumer survey with the goal of getting a better understanding of consumers' perception of potential changes in the network tariff (Naper et al., 2016). The survey was performed on focus groups which consisted of ordinary households and customers with cabins. The groups were asked to compare and state their opinions on four tariff models outlined by The Norwegian Water Resources and Energy Directorate, one of them being a TOU model.

During the interviews it became clear that the participants in general had problems contemplating network tariffs without also including electricity prices. The participants also had problems understanding electric power as a concept and how to take the grid's capacity into consideration.

The response throughout all the groups was that it was intuitively easy to understand TOU as a concept. In many groups it was compared to “rush hour” fares used in larger cities in Norway. Interestingly, this comparison was not used for the other 3 tariff models even though this logic would fit all the models. This might imply that TOU is a great model to let consumers understand the economic benefits of transferring load from high peak hours to low peak hours.

Even though the participants understood the concepts of TOU easily, the participants felt the TOU model was the most unfair and would punish those with the least flexibility. In short, many felt like they would get punished for consuming electricity during high peak hours rather than being rewarded for consuming in low-peak hours. People seem to anticipate that they would get worse off by having their network tariff changed to TOU, even though this would not be necessarily true.

3.4 Conclusions From the Literature Review

Some of the studies have problems with small sample sizes and selection bias. For instance, Klaassen et al. (2016) and Grande & Sæle (2011) have problems with both, while other studies have dealt with this problem sufficiently through random sampling and random assignment. Also, some of the studies might not be directly comparable to the Norwegian electricity market.

Another problem is that most of the studies are approximately 10 years old at this point. This is not necessarily a problem, however, there has been a substantial shift in the energy sector, especially in Norway. As mentioned earlier, EVs are getting more popular every year, smart home systems and smart grids are becoming more common, and power generation is shifting towards less predictable sources. A new pilot study in Norway will give insights whether TOU is more relevant today.

The reviewed studies in this thesis have set the TOU/dynamic tariffs in such a way that the average customer will pay the same as- or less than before. The result is often that the consumer ends up paying less. Most studies are active for 1-2 years. The TOU tariffs, and therefore also the results, are divided into summer months and winter months. This is due to the seasonality in the electricity consumption, as consumption increases due to heating appliances during the winter in colder countries. The peak hour prices under a TOU tariff are thus higher during winter as the network capacity is more constrained.

Different methods are used to assess consumption reduction. One common method is by comparing means. For instance, by comparing the difference in mean of the control group between two years and the difference in mean between two years for the treatment group. Another method is by using interpolation of the consumption plots and then comparing the area under the graphs (Torriti, 2012). Torriti also includes temperature changes as a control variable, which is a great addition.

The results vary across different studies. Some report lower morning peaks, while some report lower evening peaks. Torriti also finds that the evening peak simply just shifts to the moment the high peak prices stop.

Lastly, interventions such as feedback seem to have a greater impact on load shifting than the high peak prices by themselves. However, IHD seems to save less money than simpler means such as more frequent electricity bills. The pilot study in the Netherlands finds that more complex pricing schemes might simply confuse the consumer which results in less behavior change.

4. Experimental Design

The aim of the study is to determine if TOU will have an effect on consumption, and how four different communication strategies used to inform the customers about the TOU tariff can motivate them to respond to the assigned tariff model.

The study can be characterized as a randomized field experiment. A sensible discussion of an experiment requires an understanding of key concepts and terminologies.

In experiments, a treatment is something that researchers manipulate to a group of participants in order to study its effect so a causal relationship can be established. In the context of this study, treatments are the mix of tariff models and communication strategies.

Participants who have been exposed to the treatment are called the experimental group. Another group of participants called a controlled group, who are participants that don't receive any treatment.

Randomization refers to the random assignment of participants to the control and treatment groups. Thus, a participant has an equal chance of being part of any group. The random assignment of the participants helps to avoid selection bias as there will be no reason to expect that one group would have an advantage over the other (Heckman et al., 1998). This consequently means, in case of absence of the treatment, the outcomes of the control group's participants would not differ systematically from what the outcomes of the experimental group's participants would have been. In other words, observed and unobserved factors are likely to affect both groups equally. By comparing the outcomes of both groups after running the experiment, any difference would be attributed solely to the effect of the treatment.

Field refers to experiments that have been done in a real-world setting. This is contrary to the lab setting where participants are always alerted that they are part of an experiment so their attitude might be different to what would have been in real life. The ability to generalize the results is usually higher in the field experiments. However, this comes at the expense of losing control over all the variables that can affect experiments' participants. Therefore, high degree of control in lab experiments allow for stronger claim of causality. Nevertheless, a well-designed field experiment can neutralize the effect of external forces (Roe & Just, 2009).

4.1 The Electricity Invoice

It is worth noting that the grid tariff is considered as only one part of the electricity bill that a typical Norwegian electricity customer gets each month. The electricity bill can be classified into three components (Eriksen & Mook, 2020):

- Grid (Network) tariff covers the costs entailed by grid operators for transferring the electricity from the production sites to the customers. The grid costs have a high share of fixed “investment” costs and a low share of variable costs. The amount of revenue that a grid operator can obtain from grid users is strictly regulated by the authorities.
- Electricity price: represents the amount of consumed electricity provided by an electricity provider company that a customer can choose. A consumer pays the market price plus a commission for the service provider. The market price of electricity reflects the supply and demand of electricity per hour per region.
- Expenses and taxes: these mainly are governmental funds expenses and added value taxes.

Usually, each part makes up a third of the total electricity bill paid by the customer, however, in case of cheap electricity prices, this part becomes less than the third, and when it is expensive, it becomes more than the third.

The structure of electricity bill demonstrates that the grid tariff is not the only factor that affects consumers’ payment, so approaching customers to change their consumption pattern by appealing only to their economic sense may not be enough. The structure of the electricity bill among households in different countries in Europe can be seen in Figure 4.1. Households in Norway have relatively cheap electricity bills compared to most European countries.

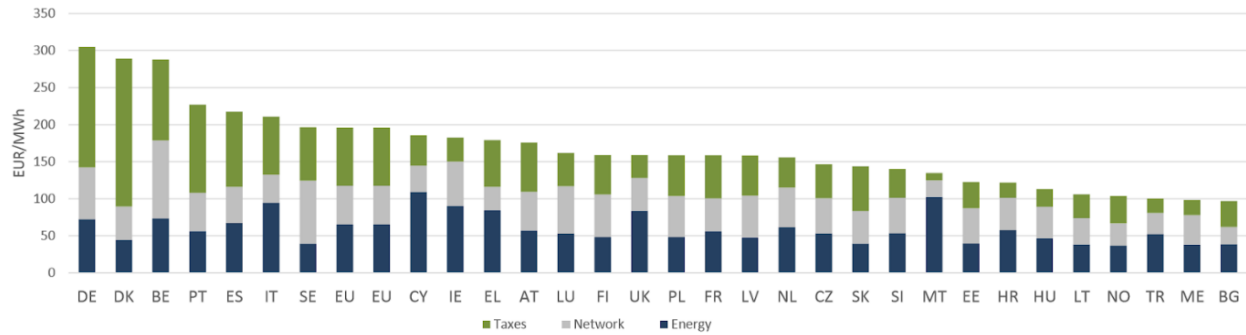

Figure 4.1 - EU Households electricity bills by components in 2017 (source: European Commission, 'Energy prices and costs in Europe', 2019)

4.2 Design

4.2.1 Sample Size

The experiment consists mainly of two groups: an experimental group and control group. The experimental group consists of 4 subgroups, as there is a distinct communication strategy for each subgroup. 1250 participants were randomly assigned for each sub-group. Practical issues have been taken into consideration in order to decide this number of participants by Elvia.

The database that has the experiment participants' data, also contains data for 8000 customers' IDs which were randomly assigned to serve as a control group. However, handling all the data for 8000 control group customers, plus the treatment groups, is computationally expensive and limits our abilities of processing the data within our current computational capabilities. Therefore, we have determined an appropriate size of the control group that allows for smooth computational operations and does not undermine the scientific merit of the study. According to Duflo et al. (2007), when more than one treatment is considered and the focus of the study is on the contrast between the control group and each treatment group, twice as many participants in the control than in each treatment group would be considered as optimal allocation. Therefore, in this study context, the data of 2500 customers are used as a control group, which have been randomly drawn from the original 8000.

4.2.2 Participants

Participants in each sub experimental group were randomly drawn and assigned from the total population of Elvia's residential customers. They have been informed through a post mail that they are part of an experiment. They had the option to opt out from the experimental tariff model by calling Elvia's customer service line and asking for it. Some customers choose to do that. When participants opt out from an experiment, this is known as attrition. A high attrition rate can pose problems when the goal is randomized trials. This is because the goal of randomization is to compare similar groups, but when participants choose to leave, the groups can become unbalanced. Thus, it is important to check the attrition rate. We will go more in depth about this problem in the discussion part. The numbers of customers who chose to remain in each sub-group are as follows can be seen in Table 1.

| Subgroup | Remaining customers | Designed size | Attrition rate |
|-----------------|----------------------------|----------------------|-----------------------|
| INGEN | 1113 | 1250 | 11% |
| KONKURRANSE | 1093 | 1250 | 12.5% |
| MILJO | 1125 | 1250 | 10% |
| SMART | 1174 | 1250 | 6% |

Table 1 - Attrition Rate: Control group did not receive any treatment; therefore, they have not been informed about the experiment.

4.3 Treatments

4.3.1 The Tariff Model

Dag & Natt

The relevant TOU tariff for this thesis is called “Dag & Natt”, which translates to “Day & Night”. Throughout the year, it is more expensive to use electricity during the day (06 - 22), than at night (22 - 06). In addition, the year is divided into two parts, summer, and winter. There is also a distinction between weekdays and weekends. The night tariff is applied at all hours on weekends (Saturday and Sunday) and on public holidays. Table 2 shows the network tariff among those who are introduced to TOU. Table 3 shows the network tariff for the control group.

| Item | Summer months | Winter Months |
|---|----------------------|----------------------|
| Variable part, Dag time (06:00 – 22:00) | 28,35 øre/kWh | 63,10 øre/kWh |
| Variable part, weekends and Natt time (22:00 – 06:00) | 25,85 øre/kWh | 28,35 øre/kWh |
| Fixed part | | |
| • Innlandet area | | |
| • Oslo/Viken area | 170 kr/month | 170 kr/month |
| | 115 kr/month | 115 kr/month |

Table 2 - TOU Tariffs Implemented by Elvia. Summer is from April to October. Winter is from November to March.

| Location | Fixed part | Variable part (Winter) | Variable part (Summer) |
|-----------------|-------------------|-------------------------------|-------------------------------|
| Innlandet | 370.83 kr/month | 30.86 øre/kWh | 27.11 øre/kWh |
| Oslo | 115 kr/ month | 44.80 øre/kWh | 44.80 øre/kWh |

Table 3 - Network Tariffs for the Control Group

4.4 Communicating TOU to the Customers

To achieve a successful DR, it is important that the customers in the treatment groups are informed about the introduction of TOU. All the 4 different treatment groups in Dag & Natt received the same introduction letter through postal mail. In addition, the participants receive differently formulated emails depending on which treatment group they are assigned to. These emails are sent sporadically, usually every 3-5 weeks.

In the introduction letter, Elvia tries to explain to the participants why they have been invited to the pilot study (See Appendix A1). It mostly refers to the limitations of the grid's capacity and that by utilizing the current grid more efficiently it is possible to prevent expanding the grid's capacity. Next, the introduction letter explains the basic concepts of the pricing model: It is less expensive to use electricity between 22:00 and 06:00. Furthermore, the letter shows the new prices and compares them to the prices prior to treatment. Lastly, the letter explains the span of the pilot study, and that they will receive email throughout the study with information and advice on how to reduce consumption.

The 4 different communication strategies each send emails to the participants at the same time. The aim of the different communication strategies is to define the best way to communicate the different tariff models to the customers and motivate them to change their consumption pattern accordingly. The content of the emails in the communication strategies are somewhat similar, but there are small nuances in the formulations that set them apart. All the emails also contain links to a website that include advice on how to reduce consumption. The participants in a communication strategy that own an EV receives an email that also focuses on EV as a tool to DR. The 4 communication (illustrated in Figure 4.2) strategies are:

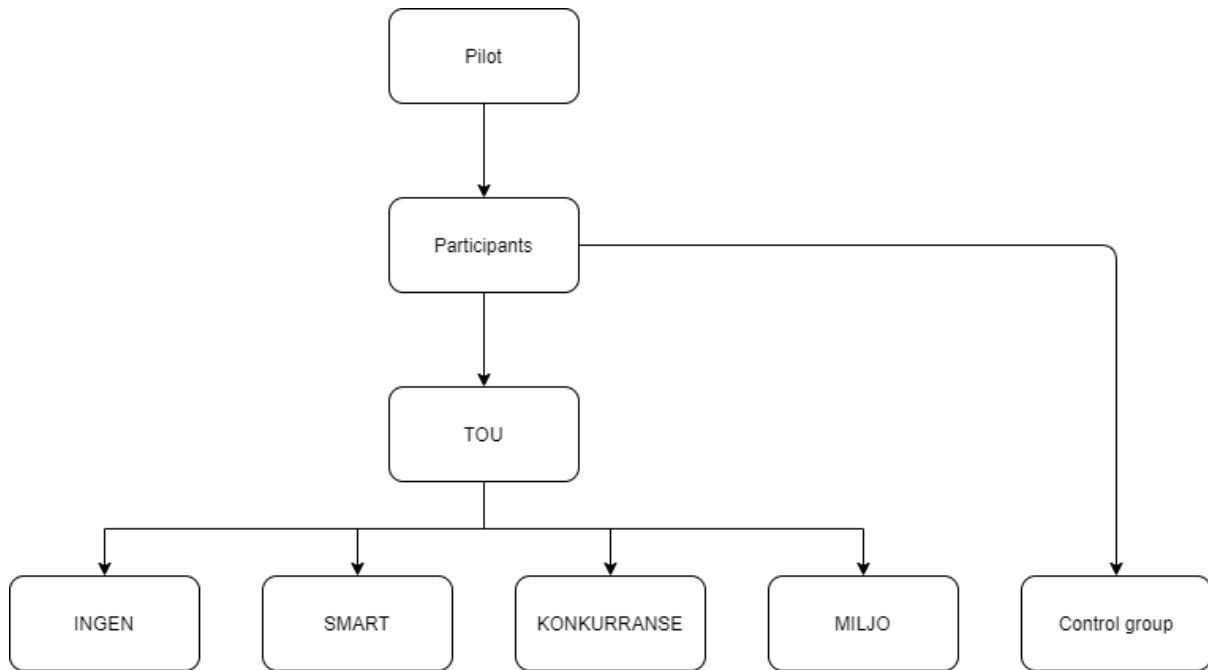

Figure 4.2 - An overview of the groups used in this study.

4.4.1 Neutral (INGEN)

The neutral communication strategy is sent to the treatment group known as INGEN (See Appendix A2). The focus of this communication strategy is simply to inform the customer about the current state of the pilot study and in the near future. For instance, during the winter, the emails inform the customers that this is the best time to save money as the price difference between day and night is larger compared to the summer.

4.4.2 Competitive (KONKURRANSE)

The aim of this communication strategy is to appeal to the customers' competitive instinct (See Appendix A3). For instance, some headlines refer to "you got more control" and "you will have the cheapest network tariff". The emails also include statements about having "cheaper network tariffs compared to your neighbors".

4.4.3 Smart Consumption (SMART)

The smart communication strategy focuses on the economic aspects of the new tariff, such as price and saving money (See Appendix A4). For instance, one headline is formulated as "We

have reduced the prices so you can save money” and “The better you understand your invoice, the more money you can save”.

4.4.4 Environment (MILJO)

This communication strategy aims to persuade the customer to change behavior by appealing to the environmental aspects of energy reduction (See Appendix A5). The content as mentioned earlier is mostly the same as the neutral communication strategy, however certain formulations such as the title is slightly different. The first email for instance includes “Now it will become cheaper to think green” and “Using electricity smartly also protects the environment” in the title.

4.5 Research Question

What is the causal interaction effect of the TOU and the four different communication strategies on customers' electricity consumption?

5. Statisitcal Analysis

5.1 Data Description and Data Quality

The raw data are smart meter readings values for each participant customer for each hour. The unit for measurement consumption is kilowatt-hour per hour (kWh/h). The meter readings cover 4 months as a control period (Nov 2019, Dec 2019, Jan 2020, Feb 2020) and 4 months when the tested tariff model came into effect (Nov 2020, Dec 2020, Jan 2021, Feb 2021).

There were some missing observations. A check has been done to find if there are any systematic trends in the missing values that could bias the analysis. It showed that these missing values are distributed equally among different groups, months, days and hours. The missing observations represented less than .5 % from the total number of observations. These observations were excluded from the analysis.

Regarding outliers, values that have been judged to represent a natural true consumption have been kept, while unrealistic values that are considered as a registration error (> 1000 kWh/h) have been removed from the analysis.

In order to control for the effect of temperature, the data for the minimum temperature degree per day have been downloaded from Norsk klimaservicesenter (2021) for the required months.

5.2 Descriptive analysis and pre experiment analysis

The aim of this section is to find if the control group and experimental groups are in the same baseline before starting the experiment. Therefore, this analysis covers only the pre-experiment period.

Table 4 demonstrates summary statistics for aggregated daily consumption per customer segmented into group types. The mean is greater than median across all the groups which indicates positive skewness.

| Group | Mean | Median | Standard Deviation | Observations | Maximum Daily Consumption |
|-------------|------|--------|--------------------|--------------|---------------------------|
| INGEN | 54.7 | 48.4 | 38.1 | 132055 | 398 |
| KONKURRANSE | 54.1 | 46.9 | 37.5 | 130077 | 307 |
| MILJO | 52.9 | 46.4 | 38.2 | 132655 | 384 |
| SMART | 58.1 | 52 | 39.5 | 139373 | 364 |
| CONTROL | 52.6 | 47.2 | 35.8 | 296816 | 437 |

Table 4 - Daily Consumption Prior to Experiment.

Figure 5.1 shows the distribution of aggregated daily consumption in kWh for each consumer in each group during the pre-experiment months.

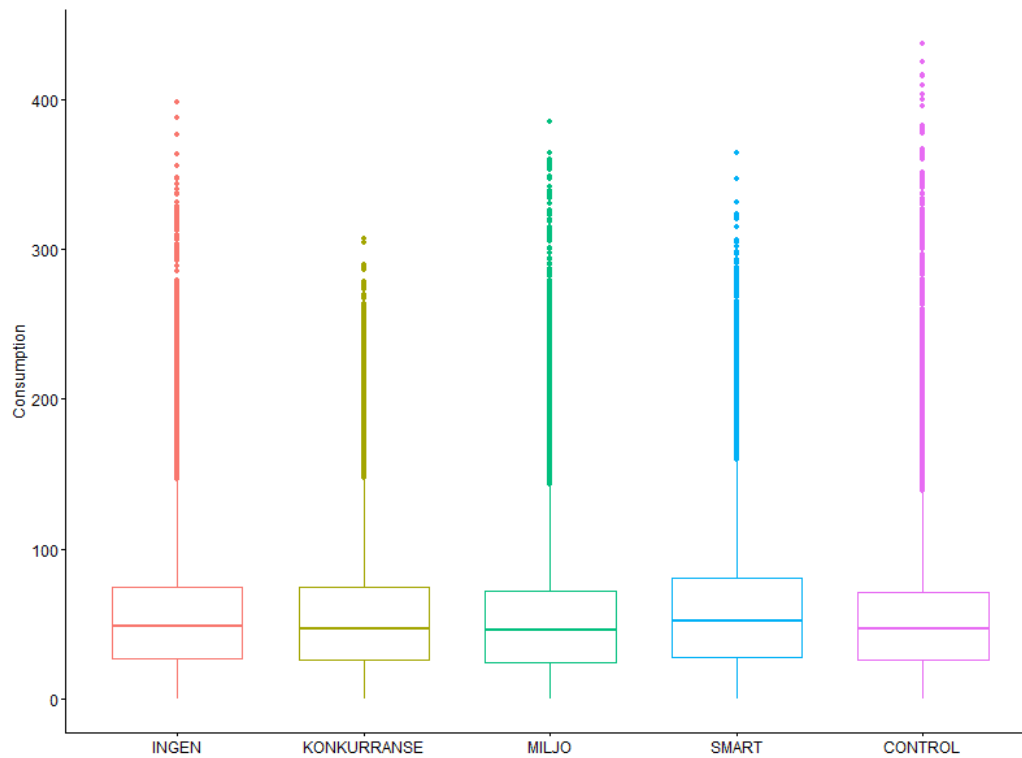

Figure 5.1 - Boxplot of the Groups in the Study. The boxplot shows that groups have relatively similar distributions with many outliers.

5.2.1 Differences between groups

To capture differences between the groups, a regression model has been built in the form of

$$Y_{id} = \alpha + \beta_1 G1_i + \beta_2 G2_i + \beta_3 G3_i + \beta_4 G4_i + \lambda_0 M_d + \lambda_1 W_d + \lambda_2 T_d + \varepsilon_{id}$$

where

- Y_{id} is the outcome of daily consumption for consumer i in day d .
- $G1_i$: group INGEN membership is coded as 1 if consumer i belongs to it, 0 otherwise.
- $G2_i$: group SMART membership is coded as 1 if consumer i belongs to it, 0 otherwise.
- $G3_i$: group KONKURRANSE membership is coded as 1 if consumer i belongs to it, 0 otherwise.
- $G4_i$: group MILJO membership is coded as 1 if consumer i belongs to it, 0 otherwise.
- M_d : Categorical variable characterizes which month that day d belongs to (2019-11 (*reference*), 2019-12, 2020-01, 2020-02).
- W_d : Categorical variable characterizes which weekday that day d is (Friday is reference).
- T_d : Minimum temperature registered at day d .
- α is the intercept.
- β_j is the difference in consumption between the control group and each treatment group G_j .
- $\lambda_0, \lambda_1, \lambda_2$ are control variables' coefficient
- ε_{id} is the error term.

Table 5 presents the results of the regression analysis. To check the model with different combination of control variables, see Appendix B1.

| Coefficient | Model estimates |
|--------------------|------------------------|
| (Intercept) | 51.92*** (0.14) |
| INGEN | 2.15*** (0.12) |
| SMART | 5.53*** (0.12) |
| KONKURRANSE | 1.52*** (0.12) |
| MILJO | 0.33** (0.12) |
| day_weekMon | -0.28 (0.15) |
| day_weekSat | 0.30 (0.15) |
| day_weekSun | 0.64*** (0.15) |
| day_weekThu | 0.14 (0.15) |
| day_weekTue | -0.02 (0.15) |
| day_weekWed | -0.53*** (0.15) |
| temp | -1.20*** (0.01) |
| month2019-12 | 1.81*** (0.12) |
| month2020-01 | -1.21*** (0.12) |
| month2020-02 | -1.71*** (0.12) |
| N | 830976 |
| R-Squared | 0.01 |

*** p < 0.001; ** p < 0.01; * p < 0.05
Standard errors are reported in parentheses

Table 5 - Differences Between Groups Prior to the Experiment

Despite the random assignment of consumers into different groups, the regression models show that there are statistically significant differences between the treatment groups and control groups in terms of the daily consumption during the pre-experiment periods. Some

differences are relatively small in magnitude such as MILJO and KONKURRANSE while SMART and INGEN have relatively bigger differences in comparison to the control group. It is worth mentioning that due to large sample size, small differences can be detected as statistically significant (Lantz, 2012).

5.3 Difference-in-Differences

The goal of this study is not only to determine if there is a statistical difference between the control and treatment groups, but also quantifying the differences, if there are any. The reason for that is to find if the magnitude of differences can be practically beneficial. Having a statistical significance implies that there is a high likelihood that the detected effect is due to the treatment and not chance. However, an effect can be statistically significant but not necessarily beneficial practically. On the other hand, if an effect is not statistically significant, then its practical significance cannot be judged. Therefore, a statistically significant effect is a necessary prerequisite for estimating the actual practical significance.

A tool that can help finding both statistical and practical significance is Ordinary least squares (OLS) regression. This can be assessed by regressing the consumption on the different groups and estimating the coefficient of each treatment group in relation to the control group.

With the current experimental design, an OLS regression using the experiment data, would be sufficient to find the differences between the control and treatment groups after starting the experiment, only in the case if there were no detected statistical differences between the groups before running the experiment. In that case, the groups would have the same baseline.

However, as it has been shown in the pre-experiment analysis section, there are detected differences even if they are small. Using a simple OLS model in this case can introduce a bias, as the model can attribute the differences that already exist between the groups before the experiment, to the treatments' effects, which is the so-called omitted-variable bias. Therefore, an alternative method must be used to control for these pre-experiment differences. This can be done by using the Difference-in-Difference estimator.

5.3.1 Why use Difference-in-differences?

Our goal is to determine the causal effect of TOU on electricity consumption. The problem is that one cannot observe the same individual both taking- and not taking the treatment at the

same time. One could start by comparing individuals that are introduced to TOU against those who are not. However, a difference between the group means often indicates selection effects, which is the average causal effect on the treated + selection bias (Angrist & Pischke 2014). Regression can make comparisons between a treatment variable D against an outcome Y . In this case Y would be consumption, while D is 1 if the individual has a TOU tariff, while X is a vector of covariates. To make sure that the comparison is as close as possible, such that one can obtain the causal effect, one has to control for certain variables. However, it is not feasible to obtain such variables on an individual level in this experiment. If it is not possible to control sufficiently, there is a risk of omitted variable bias.

The problem in this study is that there is a statistical difference of the mean between the groups. We do not have access to every variable that may impact the difference between the groups. It may not even be feasible to obtain these. One reason being that the groups are quite large, another reason is that participants can be reluctant to give up necessary information. Instead, an alternative approach will be used in the analysis.

One method that can deal with this problem is difference-in-differences (DID), which is based on the concept that by comparing the groups' changes in consumption before treatment and after the initiation of treatment, one should get the treatment effect (Angrist & Pischke 2014).

An advantage of DID is that it takes into account whether there is already a difference between the groups. It is also able to take into account certain changes that are not due to the treatment. A common problem with DID is the lack of observation before and after the treatment, which is important when determining the parallel trend assumption. As this study has sufficient data, this weakness of DID should not be a problem. Figure 5.2 illustrates the basic concept of DID.

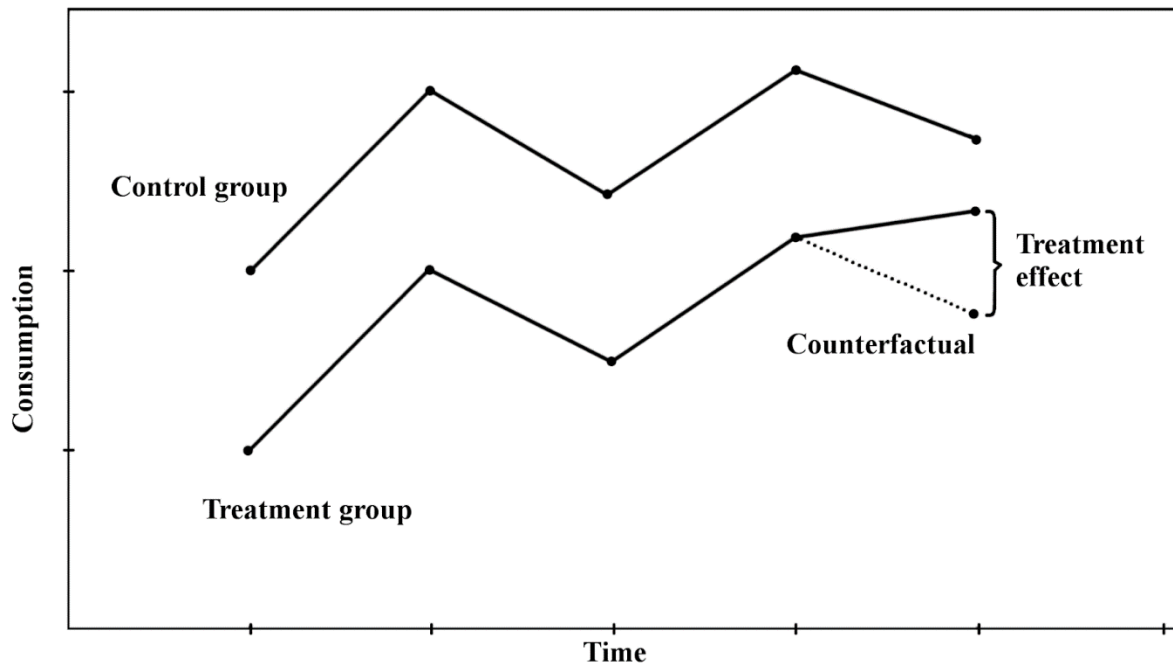

Figure 5.2 - Illustration of the DID concept. The counterfactual moves in parallel with the control group. The difference between the observed consumption and the counterfactual is the treatment effect. (Inspired by Figure 5.1 in Angrist & Pischke (2014).

5.3.2 DID Regression

Consider the basic DID regression with a control group and a single treatment group:

$$Y_{id} = \alpha + \beta \text{Treatment}_i + \gamma \text{Time}_d + \delta (\text{Treatment}_i \times \text{Time}_d) + \lambda \mathbf{X}_{id} + \varepsilon_{id}$$

Where,

- Y_{id} is the consumption of consumer i in kWh on day d .
- Treatment_i is a dummy variable which is 1 if consumer i received treatment, 0 if not.
- Time_d is a dummy variable which is 1 if day d is after the treatment has been implemented.
- α is the intercept and which is equal to the average consumption in the control group prior to treatment.
- β is the difference between the control group and the treatment group before treatment.

- δ is the coefficient of the interaction term ($Treatment_i \times Time_d$) and is the causal effect of interest.
- γ is the time trend of the control group.
- X_{id} represent a vector of control variables.

5.3.3 Assumptions

DID can be used to determine causal effects from observational data as long as its assumption criteria are met. The assumption for OLS is also relevant for DID regression. However, Angrist & Pischke (2014) points out that additionally a DID regression requires a common trends assumption. It is based on the assumption that the TOU tariff is the only thing that happens in the treatment period that may impact a difference between the treatment and control groups. This implies that the trends of the control group and the treatment group will move in parallel with each other in the case of the absence of the treatment. Since customers are randomly assigned to either control or experimental groups, this implies that there would be no potential reason that they will have no parallel trend in the absence of the treatment. Also, Figure 5.3 - The registered average hourly weekday consumption per group before treatment is initiated. show that the parallel trend prior to treatment moves in parallel, which suggests the assumption holds.

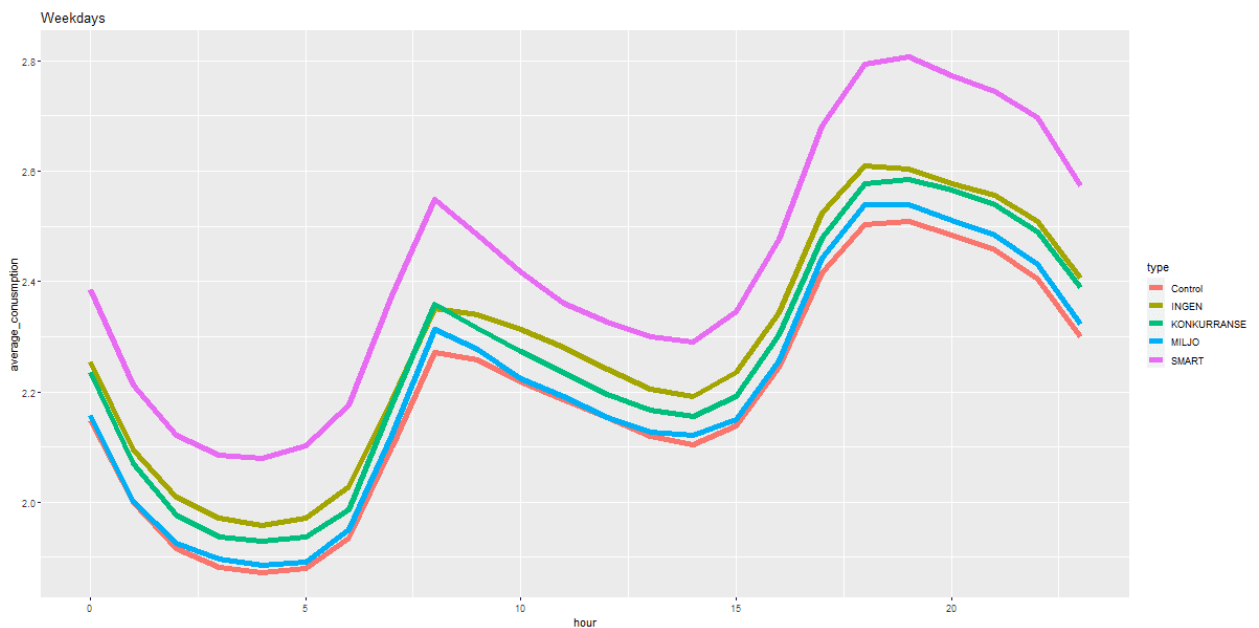

Figure 5.3 - The registered average hourly weekday consumption per group before treatment is initiated.

5.4 How Should the Results in the Analysis Be Interpreted

A common problem in research within social sciences are non-compliance problems, where some of the research subjects do not take the treatment when assigned to the treatment. To account for this, we must know how the results from the analysis should be interpreted. In treatment studies such as in this thesis, compliers are those who take treatment when (randomly) offered treatment, but do not take treatment if they are not offered treatment (Angrist & Pischke 2014). The compliers are usually the type of customers we are interested in, as they comply with treatment assignments.

Non-compliers can be divided into 3 different groups: Never takers, always-takers and defiers. Never-takers never receive treatment even though they are assigned to the treatment group. Always-takers will always take treatment, even if they are assigned to the control group, but in this study Always-takers will not be able to take treatment if assigned to control. Defiers are the test subjects that take the opposite of what their treatment assignment suggests. However, defiers are rare or even non-existent, thus one can safely assume that there are no defiers in the study. This assumption is called *monotonicity* (Angrist & Pischke 2014).

| | Assigned to treatment | Assigned to control |
|---------------|-----------------------|---------------------|
| Compliers | Treated | Not treated |
| Always-Takers | Treated | Treated |
| Never-Takers | Not treated | Not Treated |
| Defiers | Not Treated | Treated |

Table 6 - Compliance Matrix. Participants are classified into never-takers, defiers and always-takers, which are non-compliers, and into compliers. The matrix is divided into those who are assigned to TOU and control group, and whether they take the treatment or not

By taking the compliance matrix into account, it is not necessarily intuitive what the causal effect retrieved from the TOU actually represents. The results may for instance be the causal effect of both compliers and all non-compliers, or maybe the causal effect on just compliers and always takers. Angrist & Pischke (2014) mention different measures to compare treatments.

Average treatment effect (ATE) is the weighted average of treatment on never-takers, always-takers, and compliers, with the assumption of no defiers. It can be understood as the average causal effect of a population. It is the effect of treatment on a randomly selected person.

Treatment on treated effect (TOT) is the average causal effect of those who actually take treatment and is a weighted average effect on always takers and compliers.

Intention-to-treat (ITT) effect captures the causal effects on those who are being offered/assigned to treatment but does not take non-compliance into consideration.

Local average treatment effect (LATE) is the treatment effect just on compliers. LATE is the ATE but only on compliers.

Because the treatment population includes always-takers and because there is no way to tell them apart from compliers in this study, the LATE cannot be obtained by using DID. Hence, the LATE measurement can safely be excluded. The ITT includes never-takers. These are removed from the data when opting out, which means never-takers are not included in the analysis. Thus, the ITT measurement is not relevant in this pilot study. Removing never-takers from the analysis can be justified, because if TOU tariffs are implemented in the future, no one would have the choice to opt-out. This logic also applies for the ATE measurement. This leaves TOT, which measures the effect of TOU on compliers and always takers. It is important to take notice of this, as this is relevant in the context of interpreting the results later. The treatment effect can be interpreted as “What is the causal effect of TOU on those who are *offered* TOU and also *use* TOU”.

5.5 Modelling & Results

5.5.1 Model A: Dag Hours

Model A aims to test if the higher electricity price during the Dag hours has an effect on the electricity consumption for consumers during these hours across different communication strategies. The DID model is as follows:

$$Y_{id} = \alpha + \gamma T_d + \beta_1 G1_i + \beta_2 G2_i + \beta_3 G3_i + \beta_4 G4_i + \delta_1 G1_i T_d + \delta_2 G2_i T_d + \delta_3 G3_i T_d + \delta_4 G4_i T_d + \lambda_0 W_d + \lambda_1 P_d + \varepsilon_{id}$$

Where:

- Y_{id} is the outcome of aggregated consumption of Dag hours for consumer i in day d in kWh.
- T_d is a dummy variable which is 1 if *day d* is when the experiment is running, 0 otherwise. In other words, it is coded 1 if day d is in the months (Nov 2020, Dec 2020, Jan 2021, Feb 2021) and zero if it is in (Nov 2019, Dec 2019, Jan 2020, Feb 2020).
- $G1_i$: Group INGEN membership is coded as 1 if consumer i belongs to it, 0 otherwise.
- $G2_i$: Group SMART membership is coded as 1 if consumer i belongs to it, 0 otherwise.
- $G3_i$: Group KONKURRANSE membership is coded as 1 if consumer i belongs to it, 0 otherwise.
- $G4_i$: Group MILJO membership is coded as 1 if consumer i belongs to it, 0 otherwise.
- $G1_iT_d$: interaction between INGEN membership and when it is applied (treatment effect).
- $G2_iT_d$: interaction between SMART membership and when it is applied (treatment effect).
- $G3_iT_d$: interaction between KONKURRANSE membership and when it is applied (treatment effect).
- $G4_iT_d$: interaction between MILJO membership and when it is applied (treatment effect).
- W_d : Categorical variable characterizes which weekday that day d is (Friday is reference). On weekends, Natt tariff is the only one applied, thus, Saturday and Sunday are not included in this model.
- P_d : Minimum temperature registered at day d .
- γ is the time trend of the control group.
- β_j is the difference in consumption between treatment group G_j and the control group.
- δ_j is the interaction causal effect.
- λ_0, λ_1 are the covariates' coefficients
- ε_{id} is the error term

The results in Table 7 show that the four treatment effects have negative signs which indicate reduction in consumption. However, only the effects of KONKURRANSE and MILJO are statistically significant. The former group managed to reduce the consumption of Dag hours by .57 kWh on average per person, while the latter group managed to reduce the consumption of Dag hours by .64 kWh on average per person. Different versions of the model with different combination of confounding variables can be seen in Appendix B2.

| Coefficient | Model A: Dag |
|--------------------|---------------------|
| (Intercept) | 35.29*** (0.08) |
| post | 2.41*** (0.08) |
| INGEN | 1.46*** (0.11) |
| SMART | 3.79*** (0.11) |
| KONKURRANSE | 1.01*** (0.11) |
| MILJO | 0.26* (0.11) |
| post:INGEN | -0.27 (0.15) |
| post:SMART | -0.22 (0.15) |
| post:KONKURRANSE | -0.57*** (0.15) |
| post:MILJO | -0.64*** (0.15) |
| day_weekMon | 0.57*** (0.08) |
| day_weekThu | 0.31*** (0.08) |
| day_weekTue | 0.51*** (0.08) |
| day_weekWed | -0.13 (0.08) |
| temp | -1.20*** (0.01) |
| N | 1181900 |
| R-Squared | 0.05 |

*** p < 0.001; ** p < 0.01; * p < 0.05.
Standard errors are reported in parentheses

Table 7 - The Regression Estimates of Model A: Dag

Residuals Analysis

In order to check for OLS assumptions, residuals density plot has been plotted to check residuals distribution. The plot shows that the residuals have a Right-skewed distribution with a long right tail. This is in line with the distribution of consumption observations. Therefore,

the long right tail of residuals is mostly due to outliers which have been detected earlier in the boxplot graph in Figure 5.1.

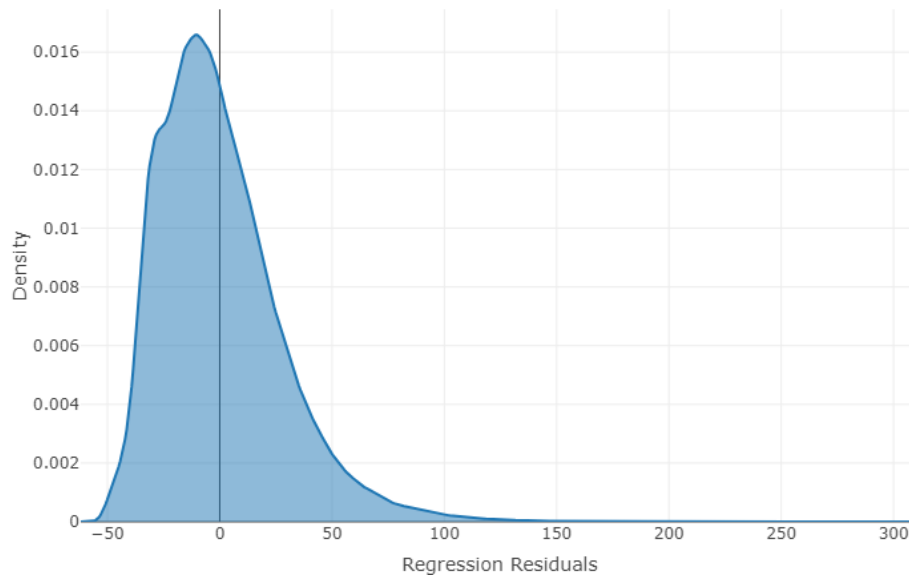

Figure 5.4 - Residual plot

Figure 5.4 shows a violation of residuals normality however, according to the Central Limit Theorem the estimators should be normally distributed because of the large sample size being used in this study, even though the error term is not. To confirm this assumption, we checked whether the estimators are biased using bootstrapping (based on 1000 replications). The results in Appendix B3 shows that the bias is relatively insignificant.

5.5.2 Month vs Month

In order to test if the treatment effect is constant across all months or there are some trends such as increased or reduced effects as months go by. A model has been built for each month. The models follow the exact same form of the previous model except that the models cover one month as an experimental period and one month as a reference period. A complete table of the models' estimates can be found in Appendix B4. Table 8 - The Causal Effect for Each Month reports interaction effects estimates.

| Coefficient | Nov 2019 vs | Dec 2019 vs | Jan 2020 vs | Feb 2020 vs |
|------------------|---------------------|---------------------|---------------------|---------------------|
| | Nov 2020 | Dec 2020 | Jan 2021 | Feb 2021 |
| (Intercept) | 36.63 *** (0.14) | 37.42 *** (0.16) | 35.05 *** (0.16) | 32.28 *** (0.17) |
| post:INGEN | -0.36 (0.27) | -0.21 (0.29) | 0.15 (0.31) | -0.67 * (0.33) |
| post:SMART | -0.57 * (0.27) | -0.24 (0.29) | 0.34 (0.31) | -0.45 (0.33) |
| post:KONKURRANSE | -0.52 (0.27) | -0.57 (0.29) | -0.70 * (0.32) | -0.47 (0.33) |
| post:MILJO | -0.50 (0.27) | -0.68 * (0.29) | -0.92 ** (0.31) | -0.46 (0.33) |
| N | 284475 | 312997 | 305920 | 278508 |
| R-Squared | 0.03 | 0.01 | 0.06 | 0.06 |

*** $p < 0.001$; ** $p < 0.01$; * $p < 0.05$.
Standard errors are reported in parentheses

Table 8 - The Causal Effect for Each Month

The results show that treatments effects vary across the months with no specific trend can be detected.

5.5.3 Model B: NATT Weekday

In order to test if the decreased consumption is a result of a shift in the consumption from DAG hours to Natt hours or simply a reduction without shifting, a model has been built to see the effect of treatments on Natt consumption during weekdays only. The model follows the same form of Model A except that it estimates aggregated consumption for Natt hours. Therefore, Y_{id} is the outcome of aggregated consumption of Natt hours for consumer i in day d . A complete table of the model's estimates can be found in Appendix B5. Table 9 reports interaction effects estimates.

| Coefficient | Model B: Natt Weekday |
|------------------|--------------------------|
| (Intercept) | 15.37 *** (0.04) |
| post:INGEN | 0.19 ** (0.07) |
| post:SMART | 0.13 (0.07) |
| post:KONKURRANSE | -0.15* (0.07) |
| post:MILJO | -0.05 (0.07) |
| N | 1184920 |
| R-Squared | 0.05 |

*** p < 0.001; ** p < 0.01; * p < 0.05.
Standard errors are reported in parentheses

Table 9 - Estimated Causal Effect During Natt Hours (Weekday).

The results show that the KONKURRANSE and MILJO treatment effects have negative signs which indicate reduction in consumption. However, only the effect of KONKURRANSE is statistically significant at the .05 level. These results indicate that the decreased consumption during Dag hours is a result of a general reduction in electricity consumption behavior that applies for both Dag and Natt hours, and not a result of shifting of consumption. On the other hand, INGEN group has a statistically significant increase in consumption.

5.5.4 Model C: NATT Weekend

In order to test if the same results of weekdays apply also for weekends, a model has been built to see the effect of treatments on daily consumption during weekends only. The model follows the same form of Model A except that it estimates aggregated daily consumption and covers only weekend days. Therefore, Y_{id} is the outcome of aggregated daily consumption for consumer i in day d and W_d Categorical variable characterizes which weekend day that day d is (Saturday is reference). A complete table of the model's estimates can be found in Appendix B6. Table 10 reports interaction effects estimates and the intercept.

| Coefficient | Model C: Natt Weekend |
|------------------|--------------------------|
| (Intercept) | 50.91*** (0.14) |
| post:INGEN | 0.22 (0.34) |
| post:SMART | 0.51 (0.33) |
| post:KONKURRANSE | -0.63 (0.34) |
| post:MILJO | -0.39 (0.34) |
| N | 494152 |
| R-Squared | 0.05 |

*** $p < 0.001$; ** $p < 0.01$; * $p < 0.05$.
Standard errors are reported in parentheses

Table 10 - Estimated Causal Effect on Weekends.

The results indicate no statistically significant results of treatment at the .05 level across all the groups. However, it follows the Dag hours pattern in terms of the sign direction, which is that KONKURRANSE and MILJO have negative signs, while SMART and INGEN have positive signs.

5.5.5 Model D: Total

In order to confirm the insight from the previous models which is that the KONKURRANSE and MILJO strategies have an effect on making consumers reduce their consumption in general, while INGEN and SMART showed no effect. A model has been built to see the effect of treatments on daily consumption. The model follows the same form of Model A except that it estimates aggregated daily consumption and covers both weekends and weekdays. Therefore, Y_{id} is the outcome of aggregated daily consumption for consumer i in day d and W_d Categorical variable characterizes which weekend day that day d is (Friday is reference). A complete table of the model's estimates can be found in Appendix B7. Table 11 reports interaction effects estimates and the intercept.

| Coefficient | Model D: Total |
|-----------------|---------------------|
| (Intercept) | 50.63 *** (0.11) |
| post:INGEN | 0.00 (0.19) |
| post:SMART | 0.10 (0.18) |
| Post:KONKYRANSE | -0.69 *** (0.19) |
| post:MILJO | -0.61 ** (0.18) |
| N | 1675323 |
| R-Squared | 0.05 |

*** $p < 0.001$; ** $p < 0.01$; * $p < 0.05$.
Standard errors are reported in parentheses

Table 11 - Estimated Causal Effect of the Aggregated daily Consumption Across the Whole Experiment.

KONKURRANSE and MILJO treatment effects are statistically significant with negative signs while INGEN and SMART have positive signs but show no statistical significance.

That confirms the insight from previous models. In general, KONKURRANSE and MILJO reduce their consumption, while INGEN and SMART show no statistical difference in consumption in relation to the control group.

5.6 Summary of the Results

In order to give better understanding of the magnitude of detected effects, it is helpful to represent them as a percentage change instead of absolute values. One way to do it, is to divide the treatment effect by the intercept. In the current models' structure, the intercept would represent the average consumption for the control group during the pre-treatment period at zero Celsius temperature, on a Friday for weekday models and on Saturday for the weekend

model. Table 12 shows the calculated percentage changes for each treatment effect for each model.

| Treatment | Weekday | | Weekend |
|--------------------|---------------------|-------------------|-------------------|
| | Dag | Natt | Natt |
| MILJO effect | -0.64*** (-1.8%) | -0.05 (-0.3%) | -0.39 (-0.76%) |
| KONKURRANSE effect | -0.57*** (-1.6%) | -0.15* (-0.9%) | -0.63 (-1.2%) |
| SMART effect | -0.22 (-0.6%) | 0.13 (0.8%) | 0.51 (1%) |
| INGEN effect | -0.27 (-0.76%) | 0.19** (1.2%) | 0.22 (0.4%) |
| Intercept | 35.29 | 15.37 | 50.91 |

*** $p < 0.001$; ** $p < 0.01$; * $p < 0.05$.
Relative percentages are reported in parentheses

Table 12 – Summary of the Results: Increase/decrease in consumption due to TOU pricing and communication relative to absence of treatment. Percentages in brackets.

6. Discussion

As mentioned previously, all results should be interpreted in the context of TOT: What is the causal effect of those who are offered TOU and remain in the treatment group. The results show a statistically significant decrease in consumption when the daytime tariffs are active for MILJO and KONKURRANSE across the treatment period. However, SMART and INGEN do not show any statistically significant results. There are no statistically significant effects for MILJO and SMART during night tariff on weekdays, while KONKURRANSE has a small statistically significant decrease in consumption, and SMART has a slight increase. On the weekends, it does not seem to be any statistical difference between either of the treatment groups and the control group, which suggests that TOU does not affect weekend consumption.

On a monthly basis, INGEN has a statistically significant reduction in February during Dag. SMART has a reduction in November, while KONKURRANSE only sees a statistically significant reduction in January. MILJO has statistically significant reduction of consumption in both December and January. It should be noted that even if not all monthly values show statistically significant results, all the values except INGEN and SMART during January have a negative sign, which can possibly indicate reduction.

6.1 Internal Validity

Even though statistically significant results show promise of a causal effect on KONKURRANSE and MILJO, we must assess the internal and external validity. The internal validity refers to how confident one is that the causal effect found is due to treatment and not due to other factors for this specific study. The framework by Slack & Draugalis (2001) will be used to assess the internal validity of this study.

A potential problem for the internal validity of the study is the maturity of the participants, which may impact consumption due to the passage of time. As the span of the study is across a whole year, it is not unreasonable to believe that events that impact the results could happen. For instance, throughout a year a household might buy or sell an EV. Even though the decision to purchase or sell an EV is not due to treatment, an EV could impact the consumption of the household. Another example could be that someone in the household decides to move out, which would reduce the consumption. However, it is sensible to believe that the maturity

changes which impact consumption, will happen randomly across the groups. As the sample size in this study is sufficiently large, the effect of these changes will likely negate each other.

Another aspect of the passage of time are factors that are external to customers, such as historical events. Natural disasters, such as landslides and drought are examples that could impact the results. For instance, landslides can do damage to the distribution network, which would prevent the customer from consuming electricity. As Norwegian power generation is heavily dependent on hydropower, a drought would have a tremendous impact on power generation. This will again result in higher spot prices, which is not directly related to the network tariff, but would still send a price signal to the same customer which could result in lower consumption. These threats are however dealt with through randomization. For instance, a landslide would have a very local impact on the power lines, but due to randomization, there will be a great geographical spread among participants. Such a local event would probably not impact the results if there were few participants in the area. An event that has an impact on a larger scale would distribute the shock evenly across the groups due to the large sample size.

Another threat to the internal validity of the study is the experimental mortality, also known as attrition. When participants drop out from the study, the results pose the risk of being based on a biased sample. As participants leave, the strength of the initial randomization mitigates because the groups can end up being unequal. This is not a problem in itself, as DID can deal with an initial difference in groups and lack of randomization. However, another threat related to experimental mortality is that the results can appear more promising than they really are. When assigned participants withdraw from the study, the remaining participants tend to be more motivated to either reduce or shift their consumption. The logic being that if you have no plans to adjust according to treatment, there really is not any incentive to participate, which leads to attrition. Without access to the data of those who withdrew from the experiment, it is difficult to apply an ITT interpretation. However, this might be justified as the interesting interpretation in the eyes of a DSO is in the context of having TOU opposed to being offered. As the attrition rate is between 6% – 12.5% (See Table 1), one should indeed take note of this, however it is not high enough to be alarming.

Most of the potential threats to internal validation are dealt with in a sufficient way, due to the large sample size, randomization, and random selection. One exception is the experimental mortality, which can potentially give biased results and should thus be kept in mind, but the

attrition rate is probably not high enough to impact the internal validity of the study. Thus, the results are most likely due to treatment.

6.2 External Validity

The economic significance of the results stems from the ability to generalize the results from the treatment groups to the whole Elvia population of 900 000 households. For example, in case of rolling out the KONKURRANSE treatment to the whole population, a potential total reduction in consumption during a day would be around $(0.69 \text{ kWh} \times 900\,000)$ which is 621 MWh. Consequently, this could have an impact by postponing upgrading the grid and reducing power loss. Nevertheless, the extent to which the study findings can be generalized requires discussing its external validity.

The external validity refers to whether the results of the study can be generalized with different participants, experimenters, and settings. The framework presented by Bracht & Glass (1968) will be used to assess the external validity of this study.

To assess the external validity of the study, Bracht & Glass (1968) suggest that dividing the threats into population validity and ecological validity. A threat related to the population validity is whether the experimental accessible population can be used to generalize the effect TOU has on the target population. The question is if the treatment effect of households is only applicable to the sample, or would similar results happen in the target population. Because the sample is randomly sampled from all the customers of Elvia, it is reasonable to believe that the results from the accessible population will give good generalization of the target population, which is Elvia's customer base. However, it is more problematic to justify a generalization of other target populations. For instance, the results may not transfer if the target population is every household in Norway, when the accessible population is only located in the eastern parts of the country. Although it could give a rough estimation on the effect of the Norwegian population as a whole, relying on the results from this study to draw certain conclusions can be dangerous.

In causal studies, one should beware of administering more than 1 treatment during the experiment. The initial TOU tariff did not give a sufficient monetary incentive for participants to partake in the study, which explains some of the attrition. To cope with the withdrawals, Elvia decided to change the TOU in such a way, that staying in the program while consuming

the same as before would result in cost-saving for the participants. This change was implemented in January 2021, which suggests that the treatment group was exposed to 2 different treatments. This may be the reason there is a high reduction in January, but it could also be something completely different. Even though it is difficult to determine the actual effect of the higher incentive TOU, the goal of the study is not to compare TOUs of different levels of incentives. Rather, the goal is to determine whether TOU has an effect, and which communication strategy yields the best results. Because the change in tariffs happened at the same time across all the treatment groups, it should not be a problem in terms of validity. However, one should keep this in mind especially looking at the monthly values.

6.3 Comparing the Results to the Literature

The decrease in consumption during the daytime for MILJO and KONKURRANSE agrees with the findings of Sæle & Grande (2011). As both studies take place in Norway, the institutional and cultural settings (such as dinner time) are closely related. Because of this, the results should be somewhat similar. In this thesis, the results show that MILJO give a reduction of 1.8% and KONKURRANSE successfully reduce consumption by 1.6%, while Sæle & Grande find that TOU result in a reduction of 4.25. One reason that they find a higher effect from treatment is probably due to the small sample size, which is only 40. While the customers of Elvia are randomly sampled and randomized into control/treatment, the participants in Malvik Everk's pilot study are not randomly selected. The participants are close geographically and have a higher interest in electricity consumption than average. Some of the reduction in their study is also due to focusing on information meetings and stickers on the washing machines. This helps the participants to remember when it is more expensive to use the appliances. Also, the peak pricing is only active between 08:00 – 10:00 and 17:00 – 19:00, compared to 06 – 22 in Elvia.

Although Klaassen et al. (2016) use dynamic prices opposed to TOU, their findings agree with our results, which is that higher prices during peak hours result in lower consumption in peak hours. They find a decrease in the evenings when the prices tend to be higher. Most of the load shifts to midday when PV generation is at its highest. They find a higher reduction (31%) in peak hour consumption than in this study, but it is not directly comparable as the households in their study are prosumers that can shift their load (20%) when PV generation is high. Also, the pricing model was dynamic pricing and not TOU.

The study by Bartusch et al. (2011) also shows similar results to this pilot study, however they find even greater reduction in consumption. They find a reduction of 11.1% the first year and 14.2% the second year. The most probable explanation for these optimistic results is the high prices during peak hours and the price set to zero during off-peak hours. Even though Elvia set a lower price during defined off-peak hours compared to peak hours, the price is somewhat similar compared to prices in the control group. In order to recoup the zero rate hours, the peak hour prices must be set higher than what Elvia has decided. Thus, the larger price difference between consuming during peak hours and off-peak hours achieves higher incentives to reduce consumption. This reasoning also applies to the successful load shift from defined peak hours to off-peak hours. This suggests that Elvia can expect greater DR by choosing a similar strategy.

Pon (2017) finds that TOU successfully reduce consumption during peak hours, but that it depends on information strategy. Bi-monthly billing results in a peak hour reduction of 4.92%, which has the smallest impact, while the treatment group that has access to IHD reduces consumption by 8.88%. The results are not directly comparable to this thesis, because the communication strategies used are different. However, both studies show that choosing the correct communications strategy is key for a successful TOU implementation. Pon's results indicate that although IHD shows promise in the start of the study, the effect diminishes over time. This might also be the case in Elvia's choice of communication strategies, but it is not easy to make a conclusion as this study's analysis are only based on 4 months, while Pon analyzes the effect throughout a whole year.

Torrito (2012) findings do not agree with either the results from this thesis or the additional literature reviewed. He finds that TOU on average increase consumption by 13.7% in Northern Italy. It is not obvious why the results differ as the research design is similar, and with a comparable price ratio between peak and off peak (0.57). But it could be that cultural differences between Norway and Italy are the explanation. Another potential reason is that participation in Torrito's study was non-voluntary. Also, the author mentions that the evening peak extends with TOU due to the lower price becoming active right after the initial peak. Because using electricity is cheaper the next hour, the Italian households might rationalize that they might as well continue using electricity. This is not the case with Elvia's TOU design. The average Norwegian household uses more electricity than the average Italian household (IEA, n.d.). This means a small change in absolute consumption results in larger changes percentage wise. Torrito (2012) also mentions that the communication with the customers is

lacking as this was mostly done through previous paper bills. This underlines the importance of selecting a good communication strategy in tandem with TOU.

6.4 Problems Related to Elvia's Pilot Project

Except for the pilot study in Northern Italy (Torriti, 2012), the results presented in the thesis show lower DR compared to similar TOU studies. Some of the reasons are mentioned earlier, such as smart appliances and motivated control groups. However, the pricing model and the choice of intervention strategy may also explain the difference in results. In the Dag & Natt tariff, the peak hour prices are defined between 06:00 - 22:00. This means that the window for high prices is spread out across many hours. The tariff model used in the study of Sæle & Grande (2011) has defined peak hours between 08:00 - 10:00 and 17:00 - 19:00, while peak hours in the Irish residential study (Pon, 2017) has defined peak hours from 17:00 - 19:00. By choosing not to have shorter defined peak pricing hours, Elvia's customers might not have a good enough incentive to shift load because the price will potentially be the same the next 12 hours. Another advantage by having shorter defined peak pricing hours is that it gives the opportunity to set higher prices. Larger price differences will give the customer higher pay-off by changing behavior.

6.5 Customer Perception - Ethical Aspects of TOU

Customer perception refers to how customers feel about TOU. It is important to understand how customers perceive TOU, in order to achieve successful DR. If customers feel like the implemented tariff is unfair, they may get demotivated. Unmotivated customers in a real-world context may be less inclined to abide by the DSO's suggestions on how to reduce or shift load. In this thesis, having motivated customers is not only important to achieve DR, but also to reduce attrition.

Higher price disparity may result in higher DR, but as Naper et al (2016) learn, participants may find TOU to be unfair. The customers may feel those who are inflexible when it comes to reducing consumption during peak hours get punished. Another possible problem is that customers feel like they subsidize cheaper nighttime consumption for those who can utilize this time period better, like EV owners. The authors also find that people tend to think that they will be worse off with TOU tariffs, even though this is not necessarily true.

Even though TOU may make sense intuitively and rationally, it does not necessarily feel fair. Thus, it becomes clearer why information and choosing the correct communication strategy are crucial components to achieve successful DR with TOU.

6.6 Possible Explanations

The basic intuition on how TOU should work is based on standard economic theory, where high demand with fixed supply will yield higher prices. The TOU framework sets high prices when the demand for electricity is high, and low prices when the demand is low. According to standard economic theory higher prices will also result in lower demand, which is essentially the goal of TOU: To lower the demand for electricity whenever the demand is high. A rational consumer thus wants to maximize his/her utility given by a utility function. Through this theory, one would expect a rational consumer to lower consumption during high priced periods, either by lowering overall consumption or shifting the load to periods with lower prices.

This of course, depends on whether lowering consumption yields a higher pay off for the consumer compared to less convenience. For instance, a rational consumer who experiences hunger after work, and thus wants to make dinner, might still have a greater payoff from using the stove during peak hours. Experiencing hunger gives discomfort, and one can assume that a consumer would be price insensitive to electricity. The standard theory still holds in this scenario. However, it is reasonable to assume that not all electrical appliances are as time-dependent and thus inflexible, as suggested by Torriti (2012) and Klaassen et al. (2016). For instance, charging an EV is probably not highly time-dependent/inflexible. The same may apply for heating (it is usually colder during the night, anyways), washing machines, dish washers and tumble dryers. If we assume that the usage of these appliances is flexible, then one might ask why consumption does not get reduced or shifts for all the intervention groups. It could be due to some unknown factor in the communication strategy negating the effect of TOU in the SMART and INGEN groups. It could also simply be due to the effect of TOU by itself is lacking, and thus it is the combination with communication that poses an effect. Nevertheless, rational consumers would reduce their consumption of flexible and price sensitive appliances during peak hours to increase their utility. It may look like the standard economic model fails to explain why SMART and INGEN do not have a statistically significant reduction during high tariff hours.

If standard economic theory fails to explain the results, maybe alternative theories can. According to DellaVigna (2009), laboratory results indicate that attention is a limited resource. By using his theory about limited attention, electricity can be perceived as a good that is divided into a visible and opaque component. Because the electricity bill in Norway consists of the electricity price, expenses, and the network tariff. This means an inattentive consumer will see the network tariff on the bill, but not fully process it, which may lead to less change in behavior by changing the price of the network tariff. Naper et al. (2016) find that households usually include electricity price when thinking of network tariff, which suggests that the spot price might be the more visible component of cost. One reason that the spot price has a higher visibility might be because it changes more often than the network tariff.

It is also reasonable to decompose the network tariff by the fixed part and the variable part, where the fixed part is the visible component, while the variable part is the opaque component. Higher consumption does not increase the cost associated with the fixed part, but it does impact the cost through the variable part. Thus, higher consumption will not increase the customers perceived cost dramatically, as the cost increases through the opaque variable part. Furthermore, changing the price of the variable part will yield a neglectable higher perceived cost.

If reducing the inattention associated with the network tariff's variable part (increasing the salience of it) will result in a more effective TOU model, then one must question why just some communication strategies in Elvia's pilot study result in statistically significant reduction of consumption, while others do not. The reasoning may simply be that INGEN and SMART fail to reduce the inattention related to the costs and benefits associated with TOU. While INGEN does not focus on a specific communication strategy, SMART tries to persuade consumers to reduce peak hours consumption by focusing on the opportunity to save money. If appealing to cost saving does not pose any statistically significant effect, it is difficult to accept that inattention to the variable cost is the only explanation. Focusing on the price would intuitively yield higher salience of the variable cost, compared to MILJO and KONKURRANSE, which focus on other aspects linked to lowering consumption. Therefore, it is interesting to find that MILJO and KONKURRANSE have statistically significant results while SMART does not.

The statistically significant results from MILJO suggests that consumers do not behave purely on self-interest. Although it is true that the environment impacts everyone to a certain degree,

the environment can be classified as a public good. This implies that consumers would have an incentive to be free riders. Because focusing on the environment yields better results than pure cost saving, consumers' utility may not be entirely dependent on their own pay-off.

A model developed by Charness & Rabin (2002) takes altruism into account. In their model, if a consumer is altruistic, he or she will have a higher utility when sharing the pay-off than keeping it only for him/herself. Because the environment is a shared good, a better environment by conserving electricity will result in a shared pay-off, and thus a higher utility for the consumer.

Regarding the statistically significant effects of KONKURRANSE, Abrahamse et al. (2005) mention comparative feedback as a measure to achieve the sense of competition and social pressure. Ayres et al. (2009) find that comparative feedback reduces energy consumption. However, throughout the experiment, Elvia has not distributed any form of feedback to compare a household's consumption relative to others. Nonetheless, the underlying sense of social pressure and competition may have a positive impact on reducing consumption even without feedback.

6.7 Limitations and Further Research

In this section, we discuss several different points that could be a potential for future research.

Based on aforementioned hypothesized explanations of the results, there could be many experiments to test it:

- Testing whether reducing the inattention to the network tariff's variable part by manipulating the consumers' salience of TOU, will have a greater effect. This can be empirically tested by removing the fixed part of the network tariff for a treatment group, while the control group will continue with both a fixed- and a variable part.
- To empirically test whether altruism plays a role in reducing electricity consumption, one can introduce the following experiment to a sample of participants: a treatment group will receive monetary compensation when they manage to save on their electricity bill. The same value will also be distributed to their neighbors; however, they save it only at specific low consumption levels of electricity at certain hours that

implies forced inconvenience.

- For testing whether providing social comparative feedback can have a greater impact or not, this can be done by implementing a field experiment by using an app. To test the causal effect of feedback, the treatment group(s) of the app will be able to compare their reduced energy usage against a group of similar households, or even friends/neighbors. On the other hand, the control group will not have this comparison feature in the app.
- From the literature, goal setting seems to be effective measures to achieve energy reduction. Elvia would benefit by investigating this further by setting high goals for energy reduction to one or more treatment groups. If results from such research are promising, the goal setting intervention should be an easy and a cheap measure to implement. As the current intervention strategy relies on communicating information to the customer's, the outcome can simply be to increase knowledge and not behavioral change in the long run. Thus, Elvia should try to combine future communication with interventions such as comparative and frequent feedback.

Interventions often have heterogeneous effects on the population they affect. That means consumers in each experimental group respond differently to the treatment, the detected effects represent only the average of effects across the whole treatment sample, but in reality, it could be that the effects vary from one consumer to another. There could be many characteristics of consumers that affect how they respond to the treatment, in terms of how much flexibility they have to change their consumption pattern or reduce it. Examples of these characteristics:

- Magnitude of consumption: it could be that households that already consume relatively high electricity have more absolute flexibility to reduce or change the time of their consumption in comparison to the households which consume relatively low.
- Load profile: a retired family would have a different load profile than a working family, different load profiles could have different amounts of flexibility to manipulate their consumption.
- Economic income: low-income consumers could respond differently to monetary incentives than high income consumers.

Studying the effects of the treatments on different types of consumers could be an interesting future research extension of this study.

The current study analyzes the effects of the treatments for only four months since the starting of the treatment. Tracking the treatment's effects for more months can clarify if the treatment effects would be attenuated over time or still at the same levels.

This study shows that the effects of the treatments are due to reduction in consumption rather than a shifting in consumption. However, there is a big potential to explore the effects of shifting consumption by automation systems as a response to price signal. Existing automation solutions in the market depend on electricity hourly spot price only in order to optimize electricity consumption that gives the best economic benefits for the consumers at their tolerated convenience levels. By introducing TOU tariff, it is interesting to see the treatment effects on consumers who have smart systems that could optimize their electricity consumption based on the merge between spot price and grid tariff.

Electricity is usually consumed by more than one member living in the household. However, in this study and in order to assure that the experiment users are not exposed to more than one treatment at the same time, Elvia preferred to communicate with the customers via direct communication means such as emails and mobile phone messages registered by the contracts' owners, this may imply that the content of the messages may not be received by other household members. The inability of confirming that all members of the same household read the message, can be avoided in rolling out the new tariff to the general public by using mass communication means like social media or TV.

The experiment period had many lockdowns in the Oslo area because of Covid-19 epidemic. This implies that many consumers had home offices and were staying in homes during the whole day. Would consumers be able to shift some of their consumption to Natt hours if they would have been outside home! This can be investigated in future research.

Spot price effect was not included in this study. Although both treatment and control groups have the same spot price, treatment groups could be more sensitive to spot price information or news in the media since they are already part of an experiment.

Through the analysis, the hours with the highest consumption have not been isolated as the defined peak hours prices in the TOU model last across the day. The DID model is easily

adjustable to fit these research questions, by analyzing sub samples, for instance certain hours of the day. However, this would best suit a TOU model which has few peak hours per day rather than an extended one like the one in this study.

7. Conclusion

The objective of this thesis is to measure the causal effect of the byproduct of TOU and communication strategies, on Elvia's end users' electric consumption. Despite the random assignments of participants into the different treatment groups, an initial analysis shows that there are statistically significant differences between the groups in terms of average consumption before starting the experiment. This requires finding a modeling technique that can take into consideration the pre-existing differences. DID is such a technique that can accurately assess the treatments' effects. This has been achieved by comparing the treatment groups to a control group, before and after the experiment.

By adding further interventions in combination to with TOU, one can nudge customers into changing their behavior, which can potentially result in greater reduction in consumption than without. By using existing literature, this thesis tries to explain why the results depend greatly on interventions such as communication strategy, and how Elvia may improve the effects of TOU by using different and/or additional interventions. From the literature, it seems like frequent feedback about the household's consumption can be good interventions. The feedback could be comparative in nature to achieve even greater results.

The current literature is approximately 10 years old. Many of the studies' participants are not randomly assigned to the treatment and have small sample sizes. The current study adds to the available literature by implementing a controlled randomized field experiment which includes several thousand participants. Additionally, this study also tests the effectiveness of various communication strategies. The results should have a strong claim on the causal effect of TOU in today's Norwegian electricity market.

The results show that the communication strategies that focus on either competition or the environment give statistically significant results in the four months from November 2020 to February 2021. The results show that the overall consumption in defined peak hours reduces by 0.57 kWh with a communication strategy focusing on competition, while the communication strategy focusing on the environmental aspect shows a reduction of 0.64 kWh. Although both the neutral and the smart/price fixated communication strategies do not show statistical significance reduction in consumption during the day compared to the counterfactual. The analysis shows that reduction during peak hours was part of overall reduction during the whole daily 24 hours.

Based on the results of this experiment, we recommend that a Norwegian DSO that wants to affect the electricity consumption of its customer, it would be better to design a communication strategy based on environmental and social pressure messages, rather than economic saving ones. Furthermore, providing feedback to the customers has been proven to be effective from the literature.

Future research should be focused on finding the effect of different communication strategies on different types of customers. Furthermore, finding the effect of using automation systems that respond to a price signal based on the merge between a grid tariff and spot price.

References

- Abrahamse, W., Steg, L., Vlek, C., & Rothengatter, T. (2005). A review of intervention studies aimed at household energy conservation. *Journal of Environmental Psychology, 25*(3), 273–291. <https://doi.org/10.1016/j.jenvp.2005.08.002>
- Ahmed, S. D., Al-Ismail, F. S. M., Shafiullah, M., Al-Sulaiman, F. A., & El-Amin, I. M. (2020). Grid Integration Challenges of Wind Energy: A Review. *IEEE Access, 8*, 10857–10878. <https://doi.org/10.1109/access.2020.2964896>
- Alasseri, R., Tripathi, A., Joji Rao, T., & Sreekanth, K. J. (2017). A review on implementation strategies for demand side management (DSM) in Kuwait through incentive-based demand response programs. *Renewable and Sustainable Energy Reviews, 77*, 617–635. <https://doi.org/10.1016/j.rser.2017.04.023>
- Alizadeh, M., Parsa Moghaddam, M., Amjady, N., Siano, P., & Sheikh-El-Eslami, M. (2016). Flexibility in future power systems with high renewable penetration: A review. *Renewable and Sustainable Energy Reviews, 57*, 1186–1193. <https://doi.org/10.1016/j.rser.2015.12.200>
- Angrist, J. D., & Pischke, J. (2014). *Mastering 'Metrics: The Path from Cause to Effect* [E-book]. Princeton University Press. <https://doi.org/10.1111/1475-4932.12266>
- Ayres, I., Raseman, S., & Shih, A. (2009). Evidence from Two Large Field Experiments that Peer Comparison Feedback can Reduce Residential Energy Usage. *SSRN Electronic Journal*. Published. <https://doi.org/10.2139/ssrn.1434950>
- Bartusch, C., Wallin, F., Odlare, M., Vassileva, I., & Wester, L. (2011). Introducing a demand-based electricity distribution tariff in the residential sector: Demand response and customer perception. *Energy Policy, 39*(9), 5008–5025. <https://doi.org/10.1016/j.enpol.2011.06.013>
- Becker, L. J. (1978a). Joint effect of feedback and goal setting on performance: A field study of residential energy conservation. *Journal of Applied Psychology, 63*(4), 428–433. <https://doi.org/10.1037/0021-9010.63.4.428>

- Becker, L. J. (1978b). Joint effect of feedback and goal setting on performance: A field study of residential energy conservation. *Journal of Applied Psychology*, 63(4), 428–433. <https://doi.org/10.1037/0021-9010.63.4.428>
- Blume, S. W. (2016). *Electric Power System Basics for the Nonelectrical Professional* (2nd ed.). Wiley-IEEE Press.
- Bracht, G. H., & Glass, G. V. (1968). The External Validity of Experiments. *American Educational Research Journal*, 5(4), 437–474. <https://doi.org/10.3102/00028312005004437>
- Charness, G., & Rabin, M. (2002). Understanding Social Preferences with Simple Tests. *The Quarterly Journal of Economics*, 117(3), 817–869. <https://doi.org/10.1162/003355302760193904>
- DellaVigna, S. (2009). Psychology and Economics: Evidence from the Field. *Journal of Economic Literature*, 47(2), 315–372. <https://doi.org/10.1257/jel.47.2.315>
- Di Cosmo, V., Lyons, S., & Nolan, A. (2014). Estimating the Impact of Time-of-Use Pricing on Irish Electricity Demand. *The Energy Journal*, 35(2), 168–218. <https://doi.org/10.5547/01956574.35.2.6>
- Drax. (2021, April 30). *Inertia: the shock absorbers keeping the grid stable*. <https://www.drax.com/power-generation/shock-absorbers-keeping-grid-stable/>
- Duflo, E., Glennerster, R., & Kremer, M. (2007). Using Randomization in Development Economics Research: A Toolkit. *SSRN Electronic Journal*. Published. <https://doi.org/10.2139/ssrn.951841>
- Eid, C., Codani, P., Perez, Y., Reneses, J., & Hakvoort, R. (2016). Managing electric flexibility from Distributed Energy Resources: A review of incentives for market design. *Renewable and Sustainable Energy Reviews*, 64, 237–247. <https://doi.org/10.1016/j.rser.2016.06.008>
- Energy facts Norway. (2019, April 9). *Security of electricity supply*. Energifakta Norge. <https://energifaktanorge.no/en/norsk-energiforsyning/forsyningssikkerhet/>

-
- Energy facts Norway. (2021, March 19). *Electricity production*.
<https://energifaktanorge.no/en/norsk-energiforsyning/kraftproduksjon/#:%7E:text=At%20the%20end%20of%202020,than%20it%20has%20for%20decades>.
- Eriksen, A. B., & Mook, V. (2020). *Proposed changes to the design of network tariffs for low voltage grid users in Norway* (V. Mook, Ed.). The Norwegian Energy Regulatory Authority. https://publikasjoner.nve.no/rme_rapport/2020/rme_rapport2020_02.pdf
- Federal Energy Regulatory Commission. (2020, December 22). *Reports on Demand Response and Advanced Metering*. <https://www.ferc.gov/industries-data/electric/power-sales-and-markets/demand-response/reports-demand-response-and>
- Geller, E. S. (1981). Evaluating Energy Conservation Programs: Is Verbal Report Enough? *Journal of Consumer Research*, 8(3), 331. <https://doi.org/10.1086/208872>
- Gellings, C. W. (2017). Evolving practice of demand-side management. *Journal of Modern Power Systems and Clean Energy*, 5(1), 1–9. <https://doi.org/10.1007/s40565-016-0252-1>
- Gönen, T. (2008). *Electric Power Distribution Engineering* (2nd ed.). CRC Press.
- Ha, M. P., Kumar, L., & Ananthapadmanabha, T. (2014). A novel approach for optimal allocation of a distributed generator in a radial distribution feeder for loss minimization and tail end node voltage improvement during peak load. *International Transaction of Electrical and Computer Engineers System*, 2(2), 67–72. <https://doi.org/10.12691/iteces-2-2-4>
- Haug, M. (2019). *Methodology for assessing short-term flexibility in demand-side assets* (Master's thesis, Norwegian University of Life Sciences, Ås). <https://nmbu.brage.unit.no/nmbu-xmlui/handle/11250/2642764>
- Heberlein, T. A., & Warriner, G. (1983a). The influence of price and attitude on shifting residential electricity consumption from on- to off-peak periods. *Journal of Economic Psychology*, 4(1–2), 107–130. [https://doi.org/10.1016/0167-4870\(83\)90048-x](https://doi.org/10.1016/0167-4870(83)90048-x)

- Heberlein, T. A., & Warriner, G. K. (1983b). The influence of price and attitude on shifting residential electricity consumption from on- to off-peak periods. *Journal of Economic Psychology*, 4(1–2), 107–130. [https://doi.org/10.1016/0167-4870\(83\)90048-x](https://doi.org/10.1016/0167-4870(83)90048-x)
- Heckman, J., Ichimura, H., Smith, J., & Todd, P. (1998). Characterizing Selection Bias Using Experimental Data. *Econometrica*, 66(5), 1017. <https://doi.org/10.2307/2999630>
- Herter, K., & Wayland, S. (2010). Residential response to critical-peak pricing of electricity: California evidence. *Energy*, 35(4), 1561–1567. <https://doi.org/10.1016/j.energy.2009.07.022>
- Huang, S., Wu, Q., Cheng, L., Liu, Z., & Zhao, H. (2016). Uncertainty Management of Dynamic Tariff Method for Congestion Management in Distribution Networks. *IEEE Transactions on Power Systems*, 31(6), 4340–4347. <https://doi.org/10.1109/tpwrs.2016.2517645>
- International Energy Agency. (n.d.). *IEA Energy Atlas*. IEA Atlas of Energy. Retrieved May 10, 2021, from <http://energyatlas.iea.org/#!/tellmap/-1118783123/1>
- IRENA. (2019). *Renewable Energy Capacity Statistics 2019*. International Renewable Energy Agency (IRENA). <https://www.irena.org/publications/2019/Mar/Renewable-Capacity-Statistics-2019>
- Jabir, H. J., Teh, J., Ishak, D., & Abunima, H. (2018). Impact of Demand-Side Management on the Reliability of Generation Systems. *Energies*, 11(8), 2155. <https://doi.org/10.3390/en11082155>
- Kalkhambkar, V., Kumar, R., & Bhakar, R. (2016). Energy loss minimization through peak shaving using energy storage. *Perspectives in Science*, 8, 162–165. <https://doi.org/10.1016/j.pisc.2016.04.022>
- Katzev, R. D., & Johnson, T. R. (1983). A social-psychological analysis of residential electricity consumption: the impact of minimal justification techniques. *Journal of Economic Psychology*, 3(3–4), 267–284. [https://doi.org/10.1016/0167-4870\(83\)90006-5](https://doi.org/10.1016/0167-4870(83)90006-5)

-
- Katzev, R. D., & Johnson, T. R. (1984). Comparing the Effects of Monetary Incentives and Foot-in-the-Door Strategies in Promoting Residential Electricity Conservation. *Journal of Applied Social Psychology, 14*(1), 12–27. <https://doi.org/10.1111/j.1559-1816.1984.tb02217.x>
- Kefayati, M., & Baldick, R. (2011). Energy Delivery Transaction Pricing for flexible electrical loads. *2011 IEEE International Conference on Smart Grid Communications (SmartGridComm)*. Published. <https://doi.org/10.1109/smartgridcomm.2011.6102348>
- Khani, H., El-Taweel, N., & Farag, H. E. Z. (2018). Power Congestion Management in Integrated Electricity and Gas Distribution Grids. *IEEE Systems Journal, 13*(2), 1883–1894. <https://doi.org/10.1109/jsyst.2018.2850882>
- Klaassen, E. A. M., Kobus, C. B. A., Frunt, J., & Sloopweg, J. G. (2016). Responsiveness of residential electricity demand to dynamic tariffs: Experiences from a large field test in the Netherlands. *Applied Energy, 183*, 1065–1074. <https://doi.org/10.1016/j.apenergy.2016.09.051>
- Lantz, B. (2012). The large sample size fallacy. *Scandinavian Journal of Caring Sciences, 27*(2), 487–492. <https://doi.org/10.1111/j.1471-6712.2012.01052.x>
- Lund, K. (2021, February 17). Vi må utnytte kraftnettet bedre. *Aftenposten*. <https://www.aftenposten.no/meninger/kronikk/i/bn7jlA/vi-maa-utnytte-kraftnettet-bedre>
- Ma, J., Silva, V., Belhomme, R., Kirschen, D. S., & Ochoa, L. F. (2013). Evaluating and Planning Flexibility in Sustainable Power Systems. *IEEE Transactions on Sustainable Energy, 4*(1), 200–209. <https://doi.org/10.1109/tste.2012.2212471>
- McCalley, L. T., & Midden, C. J. H. (2002). Energy conservation through product-integrated feedback: The roles of goal-setting and social orientation. *Journal of Economic Psychology, 23*(5), 589–603. [https://doi.org/10.1016/s0167-4870\(02\)00119-8](https://doi.org/10.1016/s0167-4870(02)00119-8)
- Naper, L. R., Haugset, A. S., & Stene, M. (2016). *Innføring av effekttariffer i distribusjonsnettet - et forklaringsproblem?* The Norwegian Water Resources and Energy Directorate. https://tfou.no/wp-content/uploads/2016/11/rapport2016_86.pdf

- Norsk klimaservicesenter. (2021, March). *Minimumstemperatur* [2019-2021].
<https://nedlasting.nve.no/klimadata/kss>
- Petkov, P., Köbler, F., Foth, M., Medland, R., & Krcmar, H. (2011). Engaging energy saving through motivation-specific social comparison. *Proceedings of the 2011 Annual Conference Extended Abstracts on Human Factors in Computing Systems - CHI EA '11*. Published. <https://doi.org/10.1145/1979742.1979855>
- Pon, S. (2017). The Effect of Information on TOU Electricity Use: an Irish residential study. *The Energy Journal*, 38(06), 55–79. <https://doi.org/10.5547/01956574.38.6.spon>
- Roe, B. E., & Just, D. R. (2009). Internal and External Validity in Economics Research: Tradeoffs between Experiments, Field Experiments, Natural Experiments, and Field Data. *American Journal of Agricultural Economics*, 91(5), 1266–1271.
<https://doi.org/10.1111/j.1467-8276.2009.01295.x>
- Sæle, H., & Grande, O. S. (2011). Demand Response From Household Customers: Experiences From a Pilot Study in Norway. *IEEE Transactions on Smart Grid*, 2(1), 102–109. <https://doi.org/10.1109/tsg.2010.2104165>
- Skar, C., Jaehnert, S., Tomasgard, A., Midthun, K. T., & Fodstad, M. (2018). *Norway's role as a flexibility provider in a renewable Europe*. Centre for Sustainable Energy Studies.
<https://www.ntnu.no/documents/7414984/1281984692/Norway%e2%80%99s+role+a+s+a+flexibility+provider+in+a+renewable+Europe.pdf/a055c776-f2a5-468f-bce2-c2cf1943f1fc>
- Slack, M. K., & Draugalis, J. R. (2001). Establishing the internal and external validity of experimental studies. *American Journal of Health-System Pharmacy*, 58(22), 2173–2181. <https://doi.org/10.1093/ajhp/58.22.2173>
- Staats, H., Wit, A., & Midden, C. (1996). Communicating the Greenhouse Effect to the Public: Evaluation of a Mass Media Campaign from a Social Dilemma Perspective. *Journal of Environmental Management*, 46(2), 189–203.
<https://doi.org/10.1006/jema.1996.0015>

-
- Statnett. (2018). *Fast Frequency Reserves 2018 - Pilot for raske frekvensreserver*.
<https://www.statnett.no/globalassets/for-aktorer-i-kraftsystemet/utvikling-av-kraftsystemet/nordisk-frekvensstabilitet/fast-frequency-reserves-pilot-2018.pdf>
- Statnett. (2021, February 13). *Tall og data fra kraftsystemet*. <https://www.statnett.no/for-aktorer-i-kraftbransjen/tall-og-data-fra-kraftsystemet/#produksjon-og-forbruk>
- The Norwegian Water Resources and Energy Directorate. (2019, September 18). *Effektuttak*. NVE. <https://www.nve.no/energibruk-effektivisering-og-teknologier/energibruk/effektuttak/?ref=mainmenu>
- The Norwegian Water Resources and Energy Directorate. (2021a, March 17). *Solkraft*. NVE. <https://www.nve.no/energiforsyning/kraftproduksjon/solkraft/?ref=mainmenu>
- The Norwegian Water Resources and Energy Directorate. (2021b, April 30). *Kraftproduksjon - NVE*. NVE. <https://www.nve.no/energiforsyning/kraftproduksjon/?ref=mainmenu>
- Torriti, J. (2012). Price-based demand side management: Assessing the impacts of time-of-use tariffs on residential electricity demand and peak shifting in Northern Italy. *Energy*, 44(1), 576–583. <https://doi.org/10.1016/j.energy.2012.05.043>
- Uddin, M., Romlie, M. F., Abdullah, M. F., Abd Halim, S., Abu Bakar, A. H., & Chia Kwang, T. (2018). A review on peak load shaving strategies. *Renewable and Sustainable Energy Reviews*, 82, 3323–3332. <https://doi.org/10.1016/j.rser.2017.10.056>
- Yahyaoui, I. (2018). *Advances in Renewable Energies and Power Technologies: Volume 1: Solar and Wind Energies* (1st ed.). Elsevier Science.
- Yan, X., Ozturk, Y., Hu, Z., & Song, Y. (2018). A review on price-driven residential demand response. *Renewable and Sustainable Energy Reviews*, 96, 411–419. <https://doi.org/10.1016/j.rser.2018.08.003>
- Yan, X., Zhang, X., Chen, H., Xu, Y., & Tan, C. (2014). Techno-economic and social analysis of energy storage for commercial buildings. *Energy Conversion and Management*, 78, 125–136. <https://doi.org/10.1016/j.enconman.2013.10.014>

Bibliography

Gerber, A. S., & Green, D. P. (2012). *Field experiments: Design, analysis, and interpretation*.
WW Norton.

Appendices

A1 – Introduction Mail from Elvia to Participatins



Side 1 av 2

\$Fornavn \$Etternavn
\$Kunde Gatnavn \$Kunde Gatenummer
\$Kunde Postnummer \$Kunde Poststed

| | |
|------------------|--------------------|
| Kundenummer | \$Kundenummer |
| Målnummer | \$Målnummer |
| Målepunkt-ID | \$Målepunkt-ID |
| Foretaksregister | NO 980 489 698 MVA |
| Sted og dato | Hamar, \$dato |

Hei \$Fornavn

Velkommen som pilotkunde for ny nettleie!

Du er tilfeldig valgt ut som testbruker av en ny modell for nettleie som heter **Nettleie Dag&Natt**. Hensikten er å gjøre det enklere og mer lønnsomt å bruke strøm smart. Fra november vil du få større mulighet til å påvirke hva du betaler i nettleie. Kort fortalt så vil det spesielt på vinteren lønne seg å flytte mest mulig av forbruket til kveld og natt, fordi prisen i disse periodene vil være lavere. Nettleie-modellen er forklart litt senere i brevet. Testen gjennomføres av oss i Elvia, som har ansvaret for drift og vedlikehold av strømmettet der du bor.

Hvorfor gjør vi dette?

Stadig mer av hverdagen vår elektrifiseres. Tenk bare på økningen i antall elbiler på norske veier de siste årene. Dette er generelt sett bra for miljøet og er en utvikling som vi i Elvia støtter. Problemer oppstår imidlertid når mange bruker mye strøm samtidig, da blir det "trangt" i strømmettet og behov for investeringer i mer nettkapasitet. Men hvis vi klarer å utnytte det eksisterende strømmettet bedre, kan vi begrense videre utbygging av strømmettet. Lavere behov for nettinvesteringer betyr lavere nettkostnader, og lavere nettleie for alle våre kunder på sikt. Vi mener derfor at en mer effektiv utnyttelse av eksisterende nettkapasitet er avgjørende for å sikre at elektrifiseringen av samfunnet vårt kan gjøres så billig som mulig.

Derfor skal vi prøve ut nye måter å ta betalt for nettleien på. Hensikten med den nye nettleiemodellen er å stimulere til å bruke strøm jevnere utover døgnet, slik at vi unngår toppene som utfordrer kapasiteten i nettet.

Hvor skjer dette?

Vi gjennomfører testen på følgende strømanlegg: \$anlegg gatnavn \$anlegg gatenummer, \$anlegg postnummer \$anlegg poststed. Vi har registrert deg som eier av dette anlegget. Er dette feil? Ta kontakt med oss, så retter vi på adressen.



Hva betyr dette for deg?

Din husstand er tilfeldig trukket ut til å prøve en nettleie-modell vi har kalt **Nettleie Dag&Natt**. Enkelt forklart betyr det at det blir billigere å bruke strøm om natten, nærmere bestemt i tidsrommet mellom klokken 22 og 06. Jo mer av forbruket ditt du kan flytte til denne tiden, desto lavere vil nettleien bli. Til sammenligning betaler du 48,33 øre/kWh i dag, uansett når på døgnet og i uken du bruker strøm. F.eks. bruker én 40 °C vask i vaskemaskinen rundt 0,5 kWh.

| | Sommer | Vinter |
|-------------------------------|---------------|---------------|
| Energiledd hverdag, kl. 06-22 | 27,65 øre/kWh | 71,70 øre/kWh |
| Energiledd natt og helg* | 25,15 øre/kWh | 28,90 øre/kWh |
| Fastledd | 200 kr/mnd | |

* Helg er hele lørdag, hele søndag og offentlige fridager.

Sommer er fra april til og med oktober. Vinter er fra november til og med mars.

Vi introduserer også et skille mellom sommer (april-oktober) og vinter (november-mars). Det gjør vi fordi det er om dagen på vinteren at vi har størst pågang i strømmettet. *Fastleddet* er den faste kostnaden du betaler for å ha tilgang til strøm, og den øker med 100 kr/mnd. Dette dekker videre kostnader tilknyttet driften av strømmettet, og kostnader til måling, avregning og fakturering.

For å lese mer om den nye nettleiemodellen kan du besøke elvia.no/pilot.

Når skjer dette?

Den nye nettleien trer i kraft 1. november 2020, og pilotprosjektet vil avsluttes 31. oktober 2021. Du trenger ikke å gjøre noe som helst, alt skjer automatisk. Dersom du ikke ønsker å delta i pilotprosjektet kan du ta kontakt med oss.

Underveis i perioden vil du motta e-poster med nødvendig informasjon og gode råd. Du kan også besøke elvia.no/pilot hvor vi har samlet flere tips og mer detaljerte beskrivelser av nettleien. Har du ytterligere spørsmål om pilotprosjektet, den nye nettleien eller annet, så er du velkommen til å ta kontakt på 02024, pilot@elvia.no eller på chat på elvia.no.

Vennlig hilsen,
Vibeke Ranum
direktør for Kundedivisjonen i Elvia

Ønsker du mer informasjon?

Vi har samlet detaljert informasjon, tips og råd på elvia.no/pilot.

A2 – Newsletter week 45 2020: INGEN

GLVIA



Vi setter ned nettleien i piloten!

Takk for tilbakemeldingene om fastleddet i piloten. Etter samtalene våre, har vi besluttet å sette ned fastleddet på nettleien i pilotprosjektet. Slik blir det mer attraktivt for flere å teste den nye nettleiemodellen. Samtidig blir det enda enklere for alle å se om forbruket man flytter påvirker totalkostnaden. For over 95% av deltakerne i piloten betyr dette at dere uansett vil spare penger som pilotkunde, selv uten å flytte noe forbruk, i tillegg til at det er mulighet for å spare ytterligere ved å delta aktivt. For resten vil det også være mulig å spare dersom man flytter nok forbruk til natt og helg.

Les mer om den oppdaterte nettleien [her](#).



Oppdatert Min Side!

Vi har nå lansert en oppdatert versjon av Min Side, hvor du kan se løpende nøyaktig hva du betaler i nettleie på ulike tider av døgnet. Det gjør det lettere for deg å følge med på ditt eget forbruk.

[Logg inn på Min Side.](#)



Tips for å jevne ut forbruket

Mens man tidligere bare kunne spare penger på å bruke mindre strøm, vil du i fremtiden kunne redusere nettleien ved å bruke like mye strøm, men på andre tider av døgnet og uken. Vi har samlet noen tips som er enkle å gjennomføre.

[Se alle tipsene her.](#)



Når mange skal bruke strøm samtidig blir det trangt – i strømmettet!

I Norge har vi rik tilgang på miljøvennlig strøm fra fornybare energikilder. I tillegg er vi opptatt av miljø og klima, noe som gjør at stadig mer av forbruket elektrifiseres. Det er fint, men det gjør at kapasiteten i strømmettet kan bli en begrensning. Vi har laget en film som dramatiserer nettopp dette.

[Se hele filmen her!](#)



Svar på spørreundersøkelse - vinn elsykkel!

Som pilotbruker vil dine erfaringer og tilbakemeldinger kunne gi oss verdifull kunnskap om hvordan den endelige nettleien bør utformes. Derfor håper vi du har anledning til å bruke tre minutter på en enkel spørreundersøkelse. Alle som deltar vil være med i trekningen av to elsykler.

[Svar på spørreundersøkelse.](#)

Dersom du har meldt deg av piloten kan du se bort fra denne mailen.

A3 – Newsletter week 45 2020: KONKURRANSE

GLVIA



Vi setter ned nettleien i piloten, så du får enda bedre kontroll!

Takk for tilbakemeldingene om fastleddet i piloten. Etter samtalene våre, har vi besluttet å sette ned fastleddet på nettleien i pilotprosjektet. Slik blir det mer attraktivt for flere å teste den nye nettleiemodellen. Samtidig blir det enda enklere for alle å se om forbruket man flytter påvirker totalkostnaden. For over 95% av deltakerne i piloten betyr dette at dere uansett vil spare penger som pilotkunde, selv uten å flytte noe forbruk, i tillegg til at det er mulighet for å spare ytterligere ved å delta aktivt. For resten vil det også være mulig å spare dersom man flytter nok forbruk til natt og helg.

Les mer om den oppdaterte nettleien [her](#).



Oppdatert Min Side!

Vi har nå lansert en oppdatert versjon av Min Side, hvor du kan se løpende nøyaktig hva du betaler i nettleie på ulike tider av døgnet. Det gjør det lettere for deg å følge med på ditt eget forbruk, så du får verifisert at eventuelle smarte styringssystemer fungerer som de skal.

[Logg inn på Min Side.](#)



Bli den beste toppkutteren!

Nye prismodeller for nettleie skal hindre unødvendig utbygging av strømmettet, som i neste runde ville gitt alle kunder dyrere nettleie. Hvis du blir best til å kutte toppene, kan strømgregningen reduseres både nå og i fremtiden.

[Se hvordan du gjør det.](#)



Når mange skal bruke strøm samtidig blir det trangt – i strømmettet!

I Norge har vi rik tilgang på miljøvennlig strøm fra fornybare energikilder. I tillegg er vi opptatt av miljø og klima, noe som gjør at stadig mer av forbruket elektrifiseres. Det er fint, men det gjør at kapasiteten i strømmettet kan bli en begrensning. Vi har laget en film som dramatiserer nettopp dette.

[Se hele filmen her!](#)



Svar på spørreundersøkelse - vinn elsykkel!

Som pilotbruker vil dine erfaringer og tilbakemeldinger kunne gi oss verdifull kunnskap om hvordan den endelige nettleien bør utformes. Derfor håper vi du har anledning til å bruke tre minutter på en enkel spørreundersøkelse. Alle som deltar vil være med i trekningen av to elsykler.

[Svar på spørreundersøkelse.](#)

Dersom du har meldt deg av piloten kan du se bort fra denne mailen.



Vi setter ned nettleien i piloten, så du kan spare mer penger!

Takk for tilbakemeldingene om fastleddet i piloten. Etter samtalene våre, har vi besluttet å sette ned fastleddet på nettleien i pilotprosjektet. Slik blir det mer attraktivt for flere å teste den nye nettleiemodellen. Samtidig blir det enda enklere for alle å se om forbruket man flytter påvirker totalkostnaden. For over 95% av deltakerne i piloten betyr dette at dere uansett vil spare penger som pilotkunde, selv uten å flytte noe forbruk, i tillegg til at det er mulighet for å spare ytterligere ved å delta aktivt. For resten vil det også være mulig å spare dersom man flytter nok forbruk til natt og helg.

Les mer om den oppdaterte nettleien [her](#).



Oppdatert Min Side!

Vi har nå lansert en oppdatert versjon av Min Side, hvor du kan se løpende nøyaktig hva du betaler i nettleie på ulike tider av døgnet. Det gjør det lettere for deg å følge med på ditt eget forbruk, noe som igjen er bra for lommeboka di.

[Logg inn på Min Side.](#)

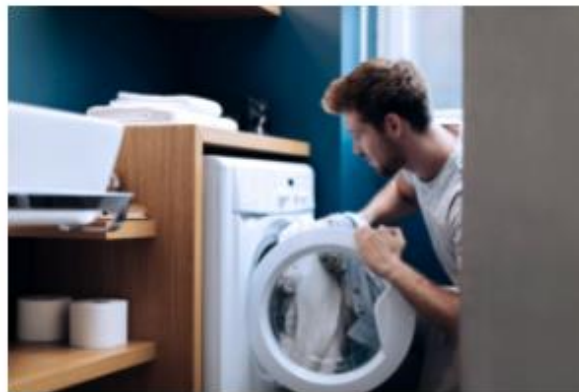

Et smartere strømforbruk krymper kostnadene.

For å kunne bruke strøm smartere og billigere, er det en rekke tiltak man kan gjøre uten at det koster noe som helst. Noen mindre investeringer kan imidlertid være lurt for å spare inn på nettleien.

[Se hvordan du gjør det.](#)



Når mange skal bruke strøm samtidig blir det trangt – i strømmettet!

I Norge har vi rik tilgang på miljøvennlig strøm fra fornybare energikilder. I tillegg er vi opptatt av miljø og klima, noe som gjør at stadig mer av forbruket elektrifiseres. Det er fint, men det gjør at kapasiteten i strømmettet kan bli en begrensning. Vi har laget en film som dramatiserer nettopp dette.

[Se hele filmen her!](#)



Svar på spørreundersøkelse - vinn elsykkel!

Som pilotbruker vil dine erfaringer og tilbakemeldinger kunne gi oss verdifull kunnskap om hvordan den endelige nettleien bør utformes. Derfor håper vi du har anledning til å bruke tre minutter på en enkel spørreundersøkelse. Alle som deltar vil være med i trekningen av to elsykler.

[Svar på spørreundersøkelse.](#)

Dersom du har meldt deg av piloten kan du se bort fra denne mailen.



Vi setter ned nettleien i piloten! Nå er det billigere å tenke grønt.

Takk for tilbakemeldingene om fastleddet i piloten. Etter samtalene våre, har vi besluttet å sette ned fastleddet på nettleien i pilotprosjektet. Slik blir det mer attraktivt for flere å teste den nye nettleiemodellen. Samtidig blir det enda enklere for alle å se om forbruket man flytter påvirker totalkostnaden. For over 95% av deltakerne i piloten betyr dette at dere uansett vil spare penger som pilotkunde, selv uten å flytte noe forbruk, i tillegg til at det er mulighet for å spare ytterligere ved å delta aktivt. For resten vil det også være mulig å spare dersom man flytter nok forbruk til natt og helg.

Les mer om den oppdaterte nettleien [her](#).



Oppdatert Min Side!

Vi har nå lansert en oppdatert versjon av Min Side, hvor du kan se løpende nøyaktig hva du betaler i nettleie på ulike tider av døgnet. Det gjør det lettere for deg å følge med på ditt eget forbruk, noe som igjen er bra for miljøet.

[Logg inn på Min Side.](#)



Å bruke strøm smart er også å skåne miljøet

Å bruke strøm smartere er også å være mer miljøvennlig. Du kan gjøre en rekke tiltak uten at det koster noe som helst. Noen mindre investeringer kan imidlertid være lurt for å spare strøm og nettleie – og for å spare naturen.

[Se hvordan du gjør det.](#)



Når mange skal bruke strøm samtidig blir det trangt – i strømmettet!

I Norge har vi rik tilgang på miljøvennlig strøm fra fornybare energikilder. I tillegg er vi opptatt av miljø og klima, noe som gjør at stadig mer av forbruket elektrifiseres. Det er fint, men det gjør at kapasiteten i strømmettet kan bli en begrensning. Vi har laget en film som dramatiserer nettopp dette.

[Se hele filmen her!](#)



Svar på spørreundersøkelse - vinn elsykkel!

Som pilotbruker vil dine erfaringer og tilbakemeldinger kunne gi oss verdifull kunnskap om hvordan den endelige nettleien bør utformes. Derfor håper vi du har anledning til å bruke tre minutter på en enkel spørreundersøkelse. Alle som deltar vil være med i trekningen av to elsykler.

[Svar på spørreundersøkelse.](#)

Dersom du har meldt deg av piloten kan du se bort fra denne mailen.

B1 – Difference between groups (pre-analysis)

| Coefficient | Model 1 | Model 2 | Model 3 | Model 4 |
|-----------------|---------------------|---------------------|--------------------|---------------------|
| (Intercept) | 52.56 *** (0.07) | 52.90 *** (0.12) | 51.52*** (0.12) | 51.92 *** (0.14) |
| INGEN | 2.15 *** (0.12) | 2.15 *** (0.12) | 2.15 *** (0.12) | 2.15 *** (0.12) |
| SMART | 5.53 *** (0.12) | 5.53 *** (0.12) | 5.53 *** (0.12) | 5.53 *** (0.12) |
| KONKURRANS E | 1.52 *** (0.12) | 1.52 *** (0.12) | 1.52 *** (0.12) | 1.52 *** (0.12) |
| MILJO | 0.33 ** (0.12) | 0.33 ** (0.12) | 0.33 ** (0.12) | 0.33 ** (0.12) |
| day_weekMon | | -1.01 *** (0.15) | -0.06 (0.15) | -0.28 (0.15) |
| day_weekSat | | -0.0555 | 0.32 * (0.15) | 0.30 (0.15) |
| day_weekSun | | -0.56 *** (0.15) | 0.89 *** (0.15) | 0.64 *** (0.15) |
| day_weekThu | | 0.32 * (0.15) | 0.13 (0.15) | 0.14 (0.15) |
| day_weekTue | | -0.0465 | 0.18 (0.15) | -0.02 (0.15) |
| day_weekWed | | -0.50 ** (0.15) | -0.53*** (0.15) | -0.53 *** (0.15) |
| temp | | | -1.26*** (0.01) | -1.20 *** (0.01) |
| pemonth2019-12 | | | | 1.81 *** (0.12) |
| month2020-01 | | | | -1.21 *** (0.12) |
| month2020-02 | | | | -1.71 *** (0.12) |
| N | 830976 | 830976 | 830976 | 830976 |
| R-Squared | 0 | 0 | 0.01 | 0.01 |

*** p < 0.001; ** p < 0.01; * p < 0.05.

Standard errors are reported in parentheses

B2 – Dag Model

| Coefficient | Model A1 | Model A 2 | Model A3 |
|------------------|---------------------|---------------------|---------------------|
| (Intercept) | 36.60 *** (0.06) | 36.84 *** (0.08) | 35.29 *** (0.08) |
| post | 4.02 *** (0.09) | 4.02 *** (0.09) | 2.41 *** (0.08) |
| INGEN | 1.46 *** (0.11) | 1.46 *** (0.11) | 1.46 *** (0.11) |
| SMART | 3.79 *** (0.11) | 3.79 *** (0.11) | 3.79 *** (0.11) |
| KONKURRANSE | 1.01 *** (0.11) | 1.01 *** (0.11) | 1.01 *** (0.11) |
| MILJO | 0.27 * (0.11) | 0.27 * (0.11) | 0.26 * (0.11) |
| post:INGEN | -0.26 (0.15) | -0.26 (0.15) | -0.27 (0.15) |
| post:SMART | -0.23 (0.15) | -0.23 (0.15) | -0.22 (0.15) |
| post:KONKURRANSE | -0.56 *** (0.16) | -0.56 *** (0.16) | -0.57 *** (0.15) |
| post:MILJO | -0.64 *** (0.15) | -0.64 *** (0.15) | -0.64 *** (0.15) |
| day_weekMon | | -0.47 *** (0.08) | 0.57 *** (0.08) |
| day_weekThu | | 0.04 (0.08) | 0.31 *** (0.08) |
| day_weekTue | | -0.32 *** (0.08) | 0.51 *** (0.08) |
| day_weekWed | | -0.44 *** (0.08) | -0.13 (0.08) |
| temp | | | -1.20 *** (0.01) |
| N | 1188808 | 1188808 | 1181900 |
| R-Squared | 0.01 | 0.01 | 0.05 |

*** p < 0.001; ** p < 0.01; * p < 0.05.

Standard errors are reported in parentheses

B3 – Bootstrap of the estimators in model A: Dag

| Coefficients | Boot Bias | Confidence Interval | |
|---------------------|------------------|----------------------------|---------------|
| | | 2.50% | 97.50% |
| (Intercept) | 0.003 | 35.14 | 35.43 |
| day_weekMon | 0.0003 | 0.417 | 0.72 |
| day_weekThu | -0.0039 | 0.16 | 0.47 |
| day_weekTue | -0.0011 | 0.357 | 0.66 |
| day_weekWed | -0.002 | -0.24 | 0.02 |
| temp | -0.0001 | -1.26 | -1.18 |
| INGEN | -0.007 | 1.28 | 1.66 |
| post | -0.001 | 2.25 | 2.57 |
| SMART | -0.001 | 3.56 | 3.991 |
| KONKURRANSE | -0.003 | 0.821 | 1.21 |
| MILJO | -0.001 | 0.074 | 0.46 |
| post:INGEN | 0.011 | -0.566 | 0.007 |
| post:SMART | -0.003 | -0.524 | 0.08 |
| post:KONKURRANSE | 0.0033 | -0.878 | -0.27 |
| post:MILJO | 0.0036 | -0.929 | -0.33 |

B4 – Month Vs Month Model

| Coefficient | Nov 2019 vs Nov 2020 | Dec 2019 vs Dec 2020 | Jan 2020 vs Jan 2021 | Feb 2020 vs Feb 2021 |
|------------------|-------------------------|-------------------------|-------------------------|-------------------------|
| (Intercept) | 36.63 *** (0.14) | 37.42 *** (0.16) | 35.05 *** (0.16) | 32.28 *** (0.17) |
| post | -1.68 *** (0.16) | 0.92 *** (0.17) | 6.69 *** (0.21) | 4.96 *** (0.19) |
| INGEN | 1.27 *** (0.19) | 1.48 *** (0.21) | 1.41 *** (0.22) | 1.70 *** (0.23) |
| SMART | 3.57 *** (0.19) | 4.07 *** (0.21) | 3.82 *** (0.21) | 3.67 *** (0.23) |
| KONKURRANSE | 0.99 *** (0.20) | 1.06 *** (0.21) | 1.12 *** (0.22) | 0.86 *** (0.24) |
| MILJO | 0.22 (0.19) | 0.41 * (0.21) | 0.35 (0.22) | 0.06 (0.23) |
| day_weekMon | -0.14 (0.14) | 0.03 (0.16) | 0.43 ** (0.16) | 1.95 *** (0.17) |
| day_weekThu | -0.60 *** (0.14) | 0.30 (0.16) | 0.62 *** (0.16) | 1.05 *** (0.17) |
| day_weekTue | -0.39 ** (0.14) | -0.27 (0.15) | 0.16 (0.16) | 2.68 *** (0.18) |
| day_weekWed | -0.61 *** (0.14) | -0.30 (0.16) | 0.23 (0.16) | 0.35 * (0.17) |
| temp | -0.94 *** (0.01) | -0.88 *** (0.02) | -0.81 *** (0.01) | -1.21 *** (0.01) |
| post:INGEN | -0.36 (0.27) | -0.21 (0.29) | 0.15 (0.31) | -0.67 * (0.33) |
| post:SMART | -0.57 * (0.27) | -0.24 (0.29) | 0.34 (0.31) | -0.45 (0.33) |
| post:KONKURRANSE | -0.52 (0.27) | -0.57 (0.29) | -0.70 * (0.32) | -0.47 (0.33) |
| post:MILJO | -0.50 (0.27) | -0.68 * (0.29) | -0.92 ** (0.31) | -0.46 (0.33) |
| N | 284475 | 312997 | 305920 | 278508 |
| R-Squared | 0.03 | 0.01 | 0.06 | 0.06 |

*** p < 0.001; ** p < 0.01; * p < 0.05.

Standard errors are reported in parentheses

B5 – Natt Model

| Coefficient | Model 1 | Model 2 | Model 3 |
|------------------|---------------------|---------------------|---------------------|
| (Intercept) | 15.95 *** (0.03) | 16.09 *** (0.04) | 15.37 *** (0.04) |
| post | 1.59 *** (0.04) | 1.59 *** (0.04) | 0.74 *** (0.04) |
| INGEN | 0.71 *** (0.05) | 0.71 *** (0.05) | 0.71 *** (0.05) |
| SMART | 1.75 *** (0.05) | 1.75 *** (0.05) | 1.75 *** (0.05) |
| KONKURRANSE | 0.49 *** (0.05) | 0.49 *** (0.05) | 0.49 *** (0.05) |
| MILJO | 0.05 (0.05) | 0.05 (0.05) | 0.05 (0.05) |
| post:INGEN | 0.19 ** (0.07) | 0.19 ** (0.07) | 0.19 ** (0.07) |
| post:SMART | 0.13 (0.07) | 0.13 (0.07) | 0.13 (0.07) |
| post:KONKURRANSE | -0.14 (0.07) | -0.14 (0.07) | -0.15* (0.07) |
| post:MILJO | -0.04 (0.07) | -0.04 (0.07) | -0.05 (0.07) |
| day_weekMon | | -0.36 *** (0.04) | 0.12 ** (0.04) |
| day_weekThu | | 0.03 (0.04) | 0.11 ** (0.04) |
| day_weekTue | | -0.25 *** (0.04) | 0.11 ** (0.04) |
| day_weekWed | | -0.12 ** (0.04) | -0.03 (0.04) |
| temp | | | -0.61 *** (0.00) |
| N | 1191834 | 1191834 | 1184920 |
| R-Squared | 0.01 | 0.01 | 0.05 |

*** p < 0.001; ** p < 0.01; * p < 0.05.

Standard errors are reported in parentheses

B6 – Natt weekend

| Coefficient | Model 1 | Model 2 | Model 3 |
|------------------|---------------------|---------------------|---------------------|
| (Intercept) | 51.04 *** (0.14) | 52.15 *** (0.15) | 50.91 *** (0.14) |
| post | 7.27 *** (0.19) | 7.31 *** (0.19) | 3.49 *** (0.19) |
| INGEN | 2.02 *** (0.24) | 2.03 *** (0.24) | 2.02 *** (0.24) |
| SMART | 5.42 *** (0.24) | 5.42 *** (0.24) | 5.42 *** (0.24) |
| KONKURRANSE | 1.51 *** (0.25) | 1.51 *** (0.25) | 1.51 *** (0.24) |
| MILJO | 0.34 (0.24) | 0.34 (0.24) | 0.34 (0.24) |
| post:INGEN | 0.21 (0.35) | 0.21 (0.35) | 0.22 (0.34) |
| post:SMART | 0.51 (0.34) | 0.51 (0.34) | 0.51 (0.33) |
| post:KONKURRANSE | -0.62 (0.35) | -0.62 (0.35) | -0.63 (0.34) |
| post:MILJO | -0.39 (0.35) | -0.39 (0.35) | -0.39 (0.34) |
| day_weekSun | | -2.23 *** (0.12) | -0.76 *** (0.11) |
| temp | | | -1.74 *** (0.01) |
| N | 494152 | 494152 | 494152 |
| R-Squared | 0.01 | 0.01 | 0.05 |

*** p < 0.001; ** p < 0.01; * p < 0.05.

Standard errors are reported in parentheses

B7 – Total effect

| Coefficient | Model 1 | Model 2 | Model 3 |
|------------------|---------------------|---------------------|---------------------|
| (Intercept) | 52.14 *** (0.07) | 52.84 *** (0.11) | 50.63 *** (0.11) |
| INGEN | 2.14 *** (0.13) | 2.14 *** (0.13) | 2.13 *** (0.13) |
| post | 6.05 *** (0.10) | 6.06 *** (0.10) | 3.24 *** (0.10) |
| SMART | 5.49 *** (0.13) | 5.49 *** (0.13) | 5.49 *** (0.13) |
| KONKURRANSE | 1.51 *** (0.13) | 1.51 *** (0.13) | 1.51 *** (0.13) |
| MILJO | 0.33 * (0.13) | 0.33 * (0.13) | 0.32 * (0.13) |
| post:INGEN | 0.00 (0.19) | 0.00 (0.19) | 0.00 (0.19) |
| post:SMART | 0.10 (0.19) | 0.10 (0.19) | 0.10 (0.18) |
| post:KONKURRANSE | -0.68 *** (0.19) | -0.68 *** (0.19) | -0.69 *** (0.19) |
| Post:MILJO | -0.60 ** (0.19) | -0.60 ** (0.19) | -0.61 ** (0.18) |
| day_weekMon | | -1.00 *** (0.12) | 0.67 *** (0.12) |
| day_weekSay | | -0.04 (0.12) | 0.36 ** (0.11) |
| day_weekSun | | -2.25 *** (0.12) | -0.35 ** (0.11) |
| day_weekThu | | -0.11 (0.12) | 0.41 *** (0.12) |
| day_weekTue | | -0.74 *** (0.12) | 0.61 *** (0.12) |
| day_weekWed | | -0.74 *** (0.12) | -0.16 (0.12) |
| temp | | | -1.79 *** (0.01) |
| N | 1675323 | 1675323 | 1675323 |
| R-Squared | 0.01 | 0.01 | 0.05 |

*** p < 0.001; ** p < 0.01; * p < 0.05.

Standard errors are reported in parentheses