

**Speed Optimization for  
Very Large Crude Carriers (VLCCs):  
Potential Savings and  
Effects of Slow Steaming**

Martine Erika Biermann Wahl  
Eirik Kristoffersen

Advisor: Stig Tenold

**NORWEGIAN SCHOOL OF ECONOMICS**

This thesis was written as a part of the Master of Science in Economics and Business Administration program - Major in Financial Economics. Neither the institution, nor the advisor is responsible for the theories and methods used, or the results and conclusions drawn, through the approval of this thesis.

## **Abstract**

The main purpose of this thesis has been to estimate the optimal speed for Very Large Crude Carriers (VLCCs), and examine how this has changed since the financial crisis in 2008.<sup>1</sup> The optimal speed will be compared with the development in actual speed for the VLCC fleet. We present two speed optimization models and provide results of optimal speed under different market conditions.

According to our results, the actual speed of VLCCs has decreased with 16% since mid 2008. Both optimization models suggest that optimal speed still is below actual speed. Our analysis further indicates that it exists a significant cost saving potential from reduced speed. We have analyzed several effects of reduced speed, including environmental, legal and piracy effects. We conclude that these will not have a significant impact on the speed decision. Our findings indicate that under the current market conditions the VLCC fleet should continue to slow steam, and in fact further reduce speed as there still exists a significant potential for cost savings.

---

<sup>1</sup>For explanation of Very Large Crude Carrier (VLCC), see section 1.4.

## Preface

This master thesis is written in the last semester of our master's degree in financial economics at the Norwegian School of Economics, spring 2012. As a result of our interest in the shipping industry, we wanted to study a topic within shipping economics. Speed optimization of vessels has become a more relevant topic after the financial crisis, and we therefore considered this an interesting topic for our dissertation.

Throughout the process we have been in contact with several individuals that have provided us with insightful thoughts and information on the subject. First and foremost, we want to thank our thesis advisor, Professor Stig Tenold. It has been very inspiring to have an advisor with such a great knowledge to the shipping industry. We are very thankful for his valuable comments on our work and general guidance through the process. In addition to our advisor, we would like to thank Petter Haugen, analyst in DNB Markets Shipping Division, for his valuable input with "the Haugen Model". He has inspired us and contributed with his expertise on speed optimization. We will also like to thank Per Gunnar Asheim, Director of Operations in Frontline, for sharing Frontline's optimal speed model with us. This helped us to quality assess our results. In addition, we appreciate the valuable comments and support with Bloomberg Data from Tian Tollefsen, shipping analyst in SEB Enskilda.

The process has been demanding, but at the same time very educational and interesting. We have enjoyed working with the topic and feel that we have developed a greater understanding of how the shipping market interacts and how a vessel's speed can adjust to these interactions. We hope the thesis will be of interest for the reader.

June 15, 2012



Martine Erika Biermann Wahl



Eirik Kristoffersen

**Contents**

- 1. Introduction ..... 10**
  - 1.1 Motivational Background ..... 10
  - 1.2 Aim of the Dissertation..... 11
  - 1.3 Structure of the Dissertation ..... 11
  - 1.4 Shipping Glossary..... 12
- 2. The Tanker Shipping Segment and the Shipping Industry..... 15**
  - 2.1 The Tanker Shipping Segment ..... 15
  - 2.2 The Economics of the Tanker Shipping Segment ..... 16
    - 2.2.1 Speed and Bunker Consumption..... 16
    - 2.2.2 Oil Prices..... 17
    - 2.2.3 Oil Prices vs. Bunker Prices..... 19
    - 2.2.4 Freight Rates ..... 20
    - 2.2.5 Market Participants ..... 21
  - 2.3 Demand and Supply..... 21
    - 2.3.1 Demand ..... 21
    - 2.3.2 Supply ..... 24
  - 2.4 Costs ..... 26
  - 2.5 Risks ..... 27
  - 2.6 Contracts..... 28
- 3. Theoretical Basis and Introduction to Speed Optimization ..... 30**
  - 3.1 The Freight Rate Mechanism ..... 30
    - 3.1.1 Supply Functions ..... 30
    - 3.1.2 Demand Functions ..... 32
    - 3.1.3 Equilibrium and Time Frame..... 32
  - 3.2 The Effect of Higher Bunker Prices ..... 34
    - 3.2.1 How Higher Bunker Prices Affect VLCC Spot Rates ..... 35

3.3 Optimal Speed – Two Models .....	37
3.3.1 The Haugen Model .....	37
3.3.2 The Meyer Model .....	43
<b>4. The VLCC Market .....</b>	<b>49</b>
4.1 VLCC Fleet Development .....	49
4.2 Development Order book .....	50
4.3 Deliveries, Demolition and Order book .....	51
4.4 Utilization .....	51
4.5 Development in Demand and Supply Growth.....	53
4.6 Historical Development in Prices .....	54
4.7 Development in Scrap Value and Average Earnings .....	55
4.8 Bunker Cost Relative to TC-cost.....	55
4.9 Converting USD/day to USD/mile .....	57
4.10 Financing Cost and Value of Cargo .....	57
4.11 Historical Average Speed of Vessels.....	59
<b>5. Optimal Speed and Potential Savings.....</b>	<b>61</b>
5.1 Optimal Speed for VLCCs.....	61
5.1.1 The Haugen Model .....	61
5.1.2 The Meyer Model .....	65
5.1.3 Average Optimal Speed .....	66
5.1.4 Historical Optimal Speed .....	69
5.2 Quality Assessment of the Models .....	69
5.2.1 Cost-Minimizing (Optimal) Speed at TD3 .....	70
5.2.2 Frontline’s Optimal Speed at TD3 .....	72
5.3 Savings from Optimal Speed.....	73
5.3.1 Savings per Day .....	73
5.3.2 Increase in TCE with Optimal Speed.....	76

<b>6. Effects of Slow Steaming.....</b>	<b>78</b>
6.1 Environmental Issues.....	78
6.1.1 CO <sub>2</sub> Emissions.....	78
6.1.2 Increased Focus on Emission Reduction .....	79
6.1.3 Calculating Emissions with Different Speed Levels .....	79
6.1.4 Criticism against Slow Steaming as an Emission Reduction Method.....	81
6.2 Market Effects .....	82
6.3 Legal Effects.....	83
6.4 Technical Issues.....	83
6.5 Organizational Issues.....	83
6.6 Piracy.....	85
<b>7. Concluding Remarks.....</b>	<b>87</b>
<b>Bibliography .....</b>	<b>89</b>
<b>Appendices .....</b>	<b>99</b>

## List of Figures

<b>1. Introduction .....</b>	<b>10</b>
<b>2. The Tanker Shipping Segment and the Shipping Industry.....</b>	<b>15</b>
Figure 2.1 <i>Speed/Consumption Relationship</i> .....	16
Figure 2.2 <i>Crude Oil Price Development</i> .....	17
Figure 2.3 <i>Oil Prices vs. Bunker Price</i> .....	19
Figure 2.4 <i>VLCC Average 1-yr TC-rate 310,000 dwt</i> .....	20
<b>3. Theoretical Basis and Introduction to Speed Optimization .....</b>	<b>30</b>
Figure 3.1 a) and b) <i>Supply Functions</i> .....	30
Figure 3.1 c and d) <i>Demand Function</i> .....	32
Figure 3.2 a) and b) <i>Short Run Freight Rate Equilibrium</i> .....	33
Figure 3.3 a) and b) <i>Slow Steaming Curves</i> .....	34
Figure 3.4 <i>A Ship's Resistance</i> .....	38
Figure 3.5 <i>Power/Speed Relationship</i> .....	39
<b>4. The VLCC Market .....</b>	<b>49</b>
Figure 4.1 <i>VLCC Fleet Development</i> .....	49
Figure 4.2 a) <i>Development Order book</i> .....	50
Figure 4.2 b) <i>Relative Division Between Crude Tankers Order book</i> .....	50
Figure 4.3 <i>Order book as a Percentage of Fleet</i> .....	51
Figure 4.4 <i>VLCC Fleet Utilization</i> .....	52
Figure 4.5 <i>Development Demand and Supply Growth</i> .....	53
Figure 4.6 <i>Development in Prices for VLCCs</i> .....	54
Figure 4.7 <i>Development VLCC Scrap Value and VLCC Average Earnings</i> .....	55
Figure 4.8 a) <i>Development of Historical Vessel and Bunker Cost</i> .....	56
Figure 4.8 b) <i>Relative Division Between Bunker and Hire Cost</i> .....	56
Figure 4.9 <i>Development of Historical Vessel and Bunker Cost USD/mile</i> .....	57
Figure 4.10 a) <i>Historical LIBOR and Cargo Value</i> .....	58

Figure 4.10 b) <i>Financing Cost USD/day</i> .....	58
Figure 4.11 <i>Historical Development in Speed</i> .....	60
<b>5. Optimal Speed and Potential Savings</b> .....	<b>61</b>
Figure 5.1 <i>Speed vs. Financing Cost</i> .....	62
Figure 5.2 <i>Historical Optimal Speed VLCCs</i> .....	69
Figure 5.3 <i>Cost-Minimizing (Optimal) Speed Laden at TD3</i> .....	70
Figure 5.4 <i>Cost-Minimizing (Optimal) Speed in Ballast at TD3</i> .....	71
Figure 5.5 <i>TCE calculations - Speed/Consumption Combinations</i> .....	76
Figure 5.6 <i>Additional Profits from Speed Optimization</i> .....	76
<b>6. Effects of Slow Steaming</b> .....	<b>78</b>
Figure 6.1 <i>CO<sub>2</sub> emissions with Different Speed Levels</i> .....	79
Figure 6.2 <i>Decrease in CO<sub>2</sub> Emissions Compared to 14.5 Knots Both Ways</i> .....	80
Figure 6.3 <i>Piracy Attacks</i> .....	85
<b>7. Concluding Remarks</b> .....	<b>87</b>
<b>Bibliography</b> .....	<b>89</b>
<b>Appendices</b> .....	<b>99</b>
Figure A <i>Load Lines – Freeboard Draught</i> .....	99
Figure B <i>Hull Dimensions</i> .....	100
Figure C <i>A Ship's resistance</i> .....	101



## List of Matrices

<b>1. Introduction .....</b>	<b>10</b>
<b>2. The Tanker Shipping Segment and the Shipping Industry.....</b>	<b>15</b>
<b>3. Theoretical Basis and Introduction to Speed Optimization .....</b>	<b>30</b>
<b>4. The VLCC Market .....</b>	<b>49</b>
<b>5. Optimal Speed and Potential Savings.....</b>	<b>61</b>
Matrix 5.1 <i>Optimal Laden Speed – The Haugen model</i> .....	63
Matrix 5.2 <i>Optimal Ballast Speed – The Haugen Model</i> .....	63
Matrix 5.3 <i>Optimal Speed – The Meyer Model</i> .....	65
Matrix 5.4 <i>Average Optimal Speed Laden – The Haugen and Meyer Model</i> .....	67
Matrix 5.5 <i>Average Optimal Speed Ballast – The Haugen and Meyer Model</i> .....	67
Matrix 5.6 <i>When to Slow Steam – The Haugen and Meyer Model</i> .....	68
Matrix 5.7 <i>Average Savings in USD per Day Compared to Full Speed</i> .....	74
<b>6. Effects of Slow Steaming.....</b>	<b>78</b>
<b>7. Concluding Remarks.....</b>	<b>87</b>
<b>Bibliography .....</b>	<b>89</b>
<b>Appendices .....</b>	<b>99</b>
Appendix G <i>Savings in USD/mile Laden – The Haugen Model</i> .....	107
Appendix G <i>Savings in USD/mile Ballast – The Haugen Model</i> .....	107
Appendix G <i>Savings in USD/day Laden - The Haugen Model</i> .....	108
Appendix G <i>Savings in USD/day Ballast - The Haugen Model</i> .....	108
Appendix G <i>Savings in USD/mile – The Meyer Model</i> .....	109
Appendix G <i>Savings in USD/day – The Meyer Model</i> .....	109

## **1. Introduction**

To structure our dissertation, we find it natural to present the background motivation for the topic we have chosen. In the following we will also give a brief description of the structure and aims of our dissertation.

### **1.1 Motivational Background**

The world financial markets are currently characterized by instability and fear. Since the Lehman Brothers' collapse in 2008, the world economy has suffered huge losses, unemployment has increased and production has been in recession. The crises emerged in the banking system in the US, and it spread fast around the world. Even though the US economy is currently recovering, the crisis has developed from being a credit crisis to a situation where several countries, especially in the Southern Europe, are deep in debt (Klovland, 2011).

The shipping markets are closely correlated to the financial markets. This fact was clearly proven after the Lehman bankruptcy, when the shipping rates also decreased dramatically. Today, the macro economic outlook is still uncertain. The shipping rates have improved since 2008, but are still very volatile in some shipping segments (Strandenes, 2011).

As a response to the decline in the shipping freight rates, speed optimization and slow steaming have become of great interest to many operators within the shipping industry. Slow steaming is not a new phenomenon, but a well-known technique to deal with oversupply, high bunker costs and low freight rates. Actually, slow steaming was an industry standard in the 1980s, but we will not emphasize this time period in our dissertation (Stopford, 2011).

Every ship has an optimal speed given the bunker price and freight rate. Even though both freight rates and fuel prices have fluctuated widely the last decade, optimal speed has still been equal to maximum speed for the merchant fleet. In 2004 the oil price started to rally and freight rates for VLCCs increased simultaneously. With both oil prices (bunker) and freight rates increasing, full speed has been optimal from an economic perspective. However, when the freight rates dropped and oil prices stayed comparably high in the wake of the financial crises, the economic optimal speed was reduced (Haugen, 2011).

## **1.2 Aim of the Dissertation**

The aim of our dissertation is to analyze to which extent slow steaming has become more widespread since the financial crisis and to discuss the consequences that this might have for the shipping market. We will try to answer two research questions through our dissertation:

1. How has the actual and optimal VLCC speed developed since the financial crises in 2008?
2. How does slow steaming affect the tanker shipping market?

## **1.3 Structure of the Dissertation**

We will in our dissertation first give a general introduction to the tanker segment and the shipping industry. Further we will elaborate the most important drivers of supply and demand, as well as some general characteristics of the tanker shipping industry. These include different costs in the shipping industry, important risk factors as well as contracts commonly used in shipping.

Thereafter we will present a theoretical basis to understand the fundamentals of speed optimization. Additionally, we will in this section present two models to compute optimal speed. These models will be used to calculate speed optimization, and be the basis to determine if slow steaming under various conditions can be optimal for the tanker segment.

After we have presented the theory, we will present the VLCC market to better understand its fundamentals. We will evaluate the development of different aspects in the market, e.g. prices, order book and fleet. This will give us a better basis before we present our models to evaluate if the financial crisis has changed the optimal speed for VLCCs.

In chapter five we will present the results from both our optimization models. We will compare the models and show potential savings from changes in speed.

In the last section we evaluate how a change in optimal speed can affect other aspects than the economic considerations we first and foremost evaluate. These aspects are environmental, market effects, legal, technological, organizational and effects of piracy. Finally we will give a conclusion to our research problems and summarize our findings.

## 1.4 Shipping Glossary

We assume the reader has some knowledge of the shipping industry, but still we would like to explain common terms used in this dissertation.

*Automatic Identification System (AIS):* This is a system with a main objective to help ships avoiding collisions and assist port authorities. The AIS transponders include a GPS which enables tracking of position and movement (Marine Traffic, 2012).

*Back-leg:* The back-leg is referred to the return trip of a round-trip, when the vessel is in ballast (explanation of ballast beneath) (Haugen, 2011).

*Ballast:* This is when a vessel is not carrying cargo, and sea water is pumped into ballast tanks to lower the ship in the water to increase stability and propeller efficiency (Stopford, 2009).

*Centistokes (cSt):* A measurement of the viscosity of oil. The viscosity of oil can be seen as a measure of the ease of movement of a fluid. The higher cSt, the higher viscosity and hence a “thicker” fluid that is harder to move. 380 cSt is usually used as marine fuel oil, while some vessels with newer engine technology are able to use more viscous, heavier and thus cheaper fuel (lower cSt) (Massey & Ward-Smith, 2011).

*Clarksons:* A leading provider of integrated shipping service. They provide a comprehensive database with observed shipping market data. Their data will be used throughout this thesis (Clarksons, 2012).

*Classification society:* Organizations, such as Det Norske Veritas (DNV), which set standards for ship construction and maintenance, and issue class certificates based on inspections done with regular intervals. (Fifty Essential Shipping Terms, Stopford 2009)

*Deadweight tonnage (dwt):* Measures the cargo-carrying capacity of a ship. The total weight of cargo a ship can carry when it is loaded to its marks equals the deadweight of the ship. This weight includes fuel, stores, water ballast, fresh water, crew and passengers with baggage. In general, the non-cargo makes up approximately 5% of the total cargo weight (Stopford, 2009).

*Deep-sea shipping:* This refers to the maritime transport of goods on intercontinental routes which are crossing oceans; as opposed to short sea shipping over relatively short distances. VLCCs typically operate in the deep-sea shipping market (Stopford, 2009).

*Design consumption:* This is the consumption of bunker when the ship steams at design speed (explanation of design speed underneath). The design consumption is often called normal consumption. It is measured in tonne/mile (Haugen, 2011).

*Design speed:* This is the speed a specific vessel is designed to steam at. The design speed is often called normal speed. The design speed depends on the relationship between the ship design/resistance and the propulsion (Haugen, 2011).

*Gross registered tonnage (grt):* This is a measure of the total permanently enclosed capacity of a ship. This equals underdeck tonnage, tweendeck tonnage (for tweendeckers), superstructures, deckhouses and other erections (Strandenes, 2011).

*Gross tonnage (gt):* This measurement was developed from grt (see explanation of grt above) as a simplified standard. Gross tonnage is calculated by a standard formula, and is equal to the total volume of all enclosed space (Strandenes, 2011).

*Intermediate Fuel Oil (IFO):* This is a mix of heavy fuel oil and gasoil. It is connected with the viscosity measured in cSt (see explanation previous page). For example the fuel denoted “IFO 380” got a maximum viscosity of 380 cSt (Bunkerworld.com, 2012).

*Knot (kt):* A unit used to measure the speed of a vessel. A knot is equal to 1,852 meters per hour or 1 nm per hour. Speed in knot is the speed above the ground, and not the speed in the water. The speed in the water varies with other physical factors like stream (U.S. Department of Transportation, 2008).

*Laden:* This is when a vessel is carrying cargo (Stopford, 2009).

*Loop:* This is a round trip for a vessel (Haugen, 2011).

*Mile (nm)*: The denotation mile is used throughout the dissertation in different settings i.e. tonne/mile, nautical mile. In the shipping vocabulary a mile refers to a nautical mile and is equal to 1,852 meters. A nautical mile is denoted nm (U.S. Department of Transportation, 2008).

*Parcel Size Distribution (PSD)*: An individual consignment of a cargo for transportation is called a parcel. Parcels come in different sizes, depending on the commodity that is being transported (Stopford, 2009).

*Tanker Dirty 3 (TD3)*: This is a specific and busy tanker route for VLCCs (see own explanation of VLCC beneath) between Ras Tanura (Saudi Arabia) and Chiba (Japan), used as a standard for contracts (Baltic Exchange, 2012).

*Time Charter Equivalent (TCE)*: This is the freight rate at Time Charter basis (after voyage costs) that is equivalent to a specific spot rate. It is adjusted for different voyage duration and denoted in USD/day. The purpose of TCE is to make it easier to compare different voyages (Strandenes, 2011).

*Twenty-foot equivalent unit (TEU)*: TEU is 20 foot long container that is used as a standard of reference measurement to describe transport capacity of containerships (Maersk, 2010).

*VLCC*: Very Large Crude Carrier, a vessel of approximately 300,000 dwt and amongst the world's largest ships. The VLCCs are basically used to transport petroleum products like crude oil and the vessels are a part of the tanker fleet (UNCTAD, 2011).

*World Scale (WS)*: This is a system which establishes freight rates for the cargo of a given oil tanker. This is made to enable a tanker to obtain the same net return per day at the same WS percentage regardless of the voyage actually undertaken. WS100, the flat-rate, indicates a standard ship, a vessel of 75,000 dwt with daily earnings of USD 12,000. Actual market rates are expressed as a percentage of the published rates e.g.; WS 100 is calculated and published and a WS of 175 is therefore 175% of the published flat rate (Worldscale.co.uk, n.d.).

## **2. The Tanker Shipping Segment and the Shipping Industry**

In this section we will describe the fundamentals behind the problems we have addressed. We will give an introduction to the tanker segment and describe the economics of the tanker shipping segment. Then we will emphasize the supply and demand factors in the shipping industry, before we take a look at other important elements like the costs associated with operating a vessel, the industry risks and the variation of contracts between charterers and shipowners.

In the following, some sections are more elaborated than others due to the relevance on our topic, but to give a general view of the industry we will start with an introduction of the main points.

### **2.1 The Tanker Shipping Segment**

The tanker shipping industry transports commodities that are usually traded in large quantities, mainly crude oil and petroleum products. Other commodities such as chemicals, wine and molten sulphur are also carried in tankers. Crude and petroleum products are easy to store and are traded in huge quantities. The vessels in the segment are the largest vessels at sea, and the tanker market represents roughly one third of the seaborne trade in volume. With petroleum being the raw ingredient for about 70,000 products we use every day, the tanker freight rates are closely linked to the aggregate demand. The size of the vessels range from 10,000 to 550,000 dwt.<sup>2</sup> One of the most common vessels in the tanker segment is the Very Large Crude Carrier (VLCC). A VLCC is approximately 300,000 dwt and is one of the largest vessels in the world. VLCCs offer huge economies of scale when transporting oil where mainland pipelines are not an alternative (UNCTAD, 2011) (Culliane & Khanna, 2000). In our dissertation we will focus on the VLCC class, since this constitutes the largest proportion of the tanker transport capacity within the tanker segment.

Within tanker transport, there is integrated transport systems for handling the cargo carried. Oil needs advanced terminals to handle the discharging and further refining. Another characteristic of the tanker segment is that the vessels often carry commodities only one way. This is a consequence of the petroleum industry. Naturally, oil is transported from an oil field

---

<sup>2</sup> For explanation of dwt, see section 1.4.

to a refinery on the mainland, and not vice versa. The back-leg of a loop will therefore often consist of minimal cargo (Strandenes, 2011).

Oil tankers carry large quantities which result in significant economies of scale for the tanker shipping segment. The operational cost per cargo unit diminishes as the size of vessel and cargo capacity increases (until a certain level due to e.g. canal limitations) (Stopford, 2009).

### 2.2 The Economics of the Tanker Shipping Segment

To evaluate the problem we have addressed, it is important to understand the economics of the tanker segment. Firstly, we will describe the relationship between speed and bunker consumption. Secondly we will look at the development in oil prices and the relationship between oil and bunker prices, before we describe the development in freight rates to get a better understanding of how crucial they are to the tanker market. Lastly we will describe the market participants.

#### 2.2.1 Speed and Bunker Consumption

To understand the fundamentals behind speed optimization, we need to elaborate the relationship between bunker fuel consumption and vessel speed. This is the basis for the potential gains of optimizing the speed of vessels.

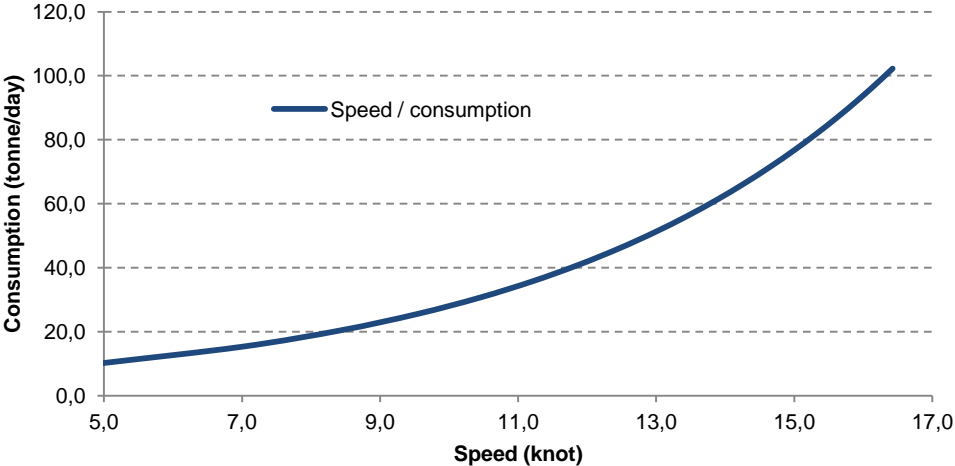

Figure 2.1 Speed/Consumption Relationship (Clarksons and Haugen, 2012)

From the graph we can see that the consumption rises exponentially as the speed increases. This is consistent with any other fuel-consuming vehicle and essential to describe why the VLCC's speed affects the tanker shipping segment. Because of the exponential trend, a small



reduction at higher speed levels (speed > 13 knot) will have major impact on the total fuel consumption. If the relationship between speed and consumption was constant, speed optimization would not be of relevance.

### 2.2.2 Oil Prices

The oil price is of great importance for the tanker market since oil is the most transported commodity, and also represents the main operational cost. Hence, fluctuations in oil prices will have a greater impact on the tanker market than other shipping segments (Stopford, 2009).

The price of oil has risen significantly since 2004. The increase had a dip in 2009, but figure 2.2 shows that the oil price today is almost at the same level as the all time high level in 2008. According to DNB Markets they are expecting the oil price to increase further (DNB Markets, 2012).

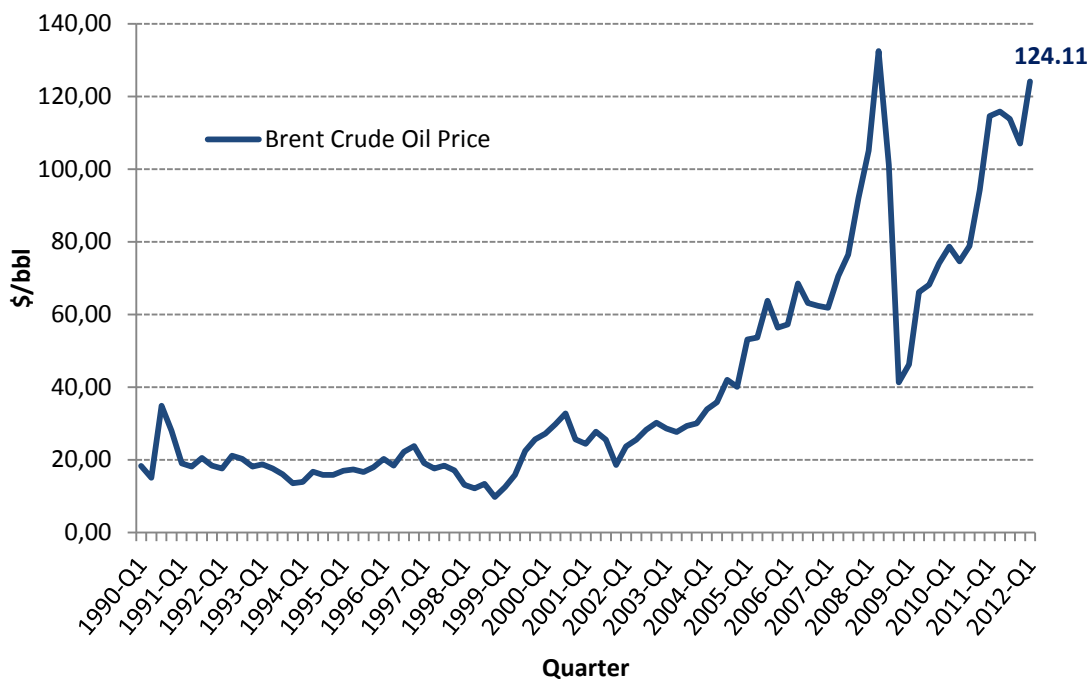

Figure 2.2 Crude Oil Price Development

(Clarksons, 2012)

There are different factors driving the long term oil prices. We will present some of these factors and how they may support the assumption of continued increasing oil prices.

### ***Demand Drivers***

Firstly, there is a global dependence of oil. According to analyses from DNB Markets the demand for oil can be seen as more robust than earlier years. This is due to the fact that the oil price has stayed above 100 USD/barrel after the financial crisis (DNB Markets, 2012).

China, as a main consumer of oil, can explain some of the increase in demand. The power crises in China in 2004 and 2010 resulted in a switch from coal to diesel and residual fuel. This, in addition to the massive expansion of infrastructure in China, can explain the increase in demand after the millennium (DNB Markets, 2012).

Emerging markets (including China) have increased their market share in the demand for oil substantially the recent years. The emerging markets have gone from having 1/3 of the market share 30 years ago, to now constitute 50% of the market. Many of the emerging markets have a significant growth in GDP, which result in an increased demand for oil. This shows that the demand drivers are strong and will probably keep oil prices high, at least in the medium term (DNB Markets, 2012).

### ***Supply Drivers***

The instability in the Middle East is one of many factors that makes it difficult to forecast the oil price in the upcoming years (Lloyd's, 2011). According to Nordea Markets' report from January, the supply disruptions from major oil producing countries such as Iran, Iraq, Nigeria and Sudan may limit oil flows to the global oil market, and hence push up the risk premium by an average of 5 USD/barrel. The situation in Iran, where they threaten to close the Strait of Hormuz and thus decrease the oil supply, leads to volatile prices. If the threat is carried out, it will probably lead to higher oil prices (Nordea Markets, 2012).

From both supply and demand drivers we see that many factors suggest that the oil prices will continue to stay high. Later in the dissertation we will elaborate how changes in oil prices may affect the optimal speed of VLCCs.

### 2.2.3 Oil Prices vs. Bunker Prices

Bunker prices vary in accordance to what kind of fuel oil the ship uses. We will in our dissertation assume that all VLCCs use 380cSt as fuel.<sup>3</sup> To describe the development in bunker prices we will use an average of bunker prices (380cSt) from Rotterdam, Singapore and Fujairah. These three geographical areas have approximately the same bunker prices.

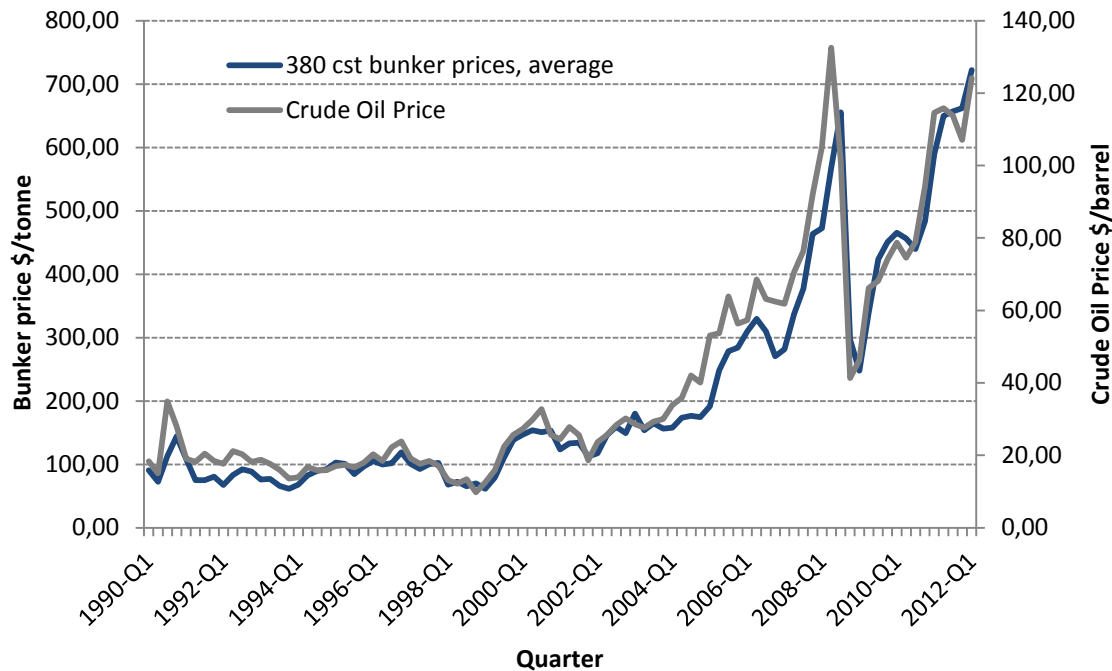

Figure 2.3 Oil Prices vs. Bunker Prices

(Clarksons, 2012)

We observe from the figure above that bunker prices and oil prices are to an outmost extent correlated with a correlation of approximately 0.98. This close to perfect correlation is confirmed by the leading daily newspaper for the maritime industry, Lloyd's Shipping Economist (Lloyd's, 2011). Bunker prices are relevant for our speed optimization, and throughout our dissertation we will therefore assume that a change in oil price will lead to a similar change in bunker prices as well.

In the next chapter we will look at the freight rates which are, in connection with the bunker prices, of great importance to the economics of the tanker shipping segment.

<sup>3</sup> For explanation of cSt, see glossary section 1.4.

## 2.2.4 Freight Rates

During the last two decades we have seen highly volatile VLCC rates. The main reason for the historical high volatility is the demand that quickly changes while supply is rigid. The peaks and troughs are a result of the inelastic demand in the market (Stopford, 2009).

Additionally, the numbers of competitors, alternative transport methods and bargaining power of the service user (the charterer) have an influence on the freight rates (UNCTAD, 2011).

The last years, China has had a substantial growth in demand for oil/VLCC transport. But in spite of the increased demand, the freight rates dropped in 2005. Following, 2006 and 2007 were fairly strong, as an effect of higher bunker costs, increased oil production and longer haul. At the end of 2007 this resulted in shortage of tonnage, which resulted in a freight rate boom (Andersen, 2008).

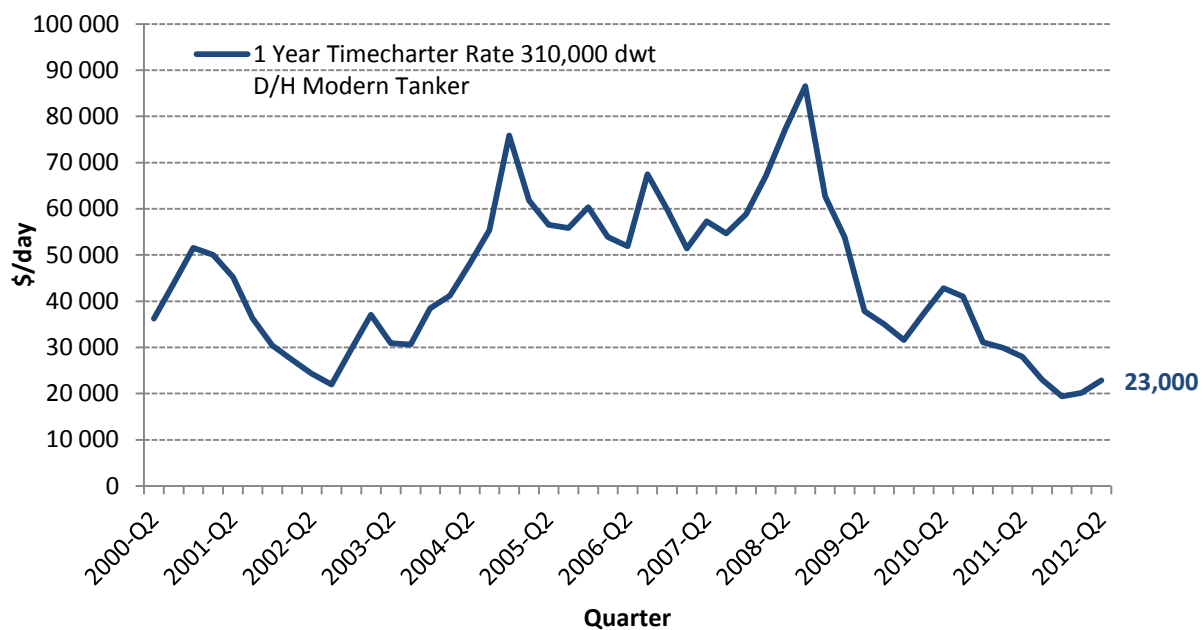

Figure 2.4 VLCC Average 1-yr TC-rate 310,000 dwt

(Clarksons, 2012)

Figure 2.4 shows that during 2009 and 2010 overall one year TC-rates declined after some turbulence due to market sentiment and seasonal demand. Still, the increasing supply was the main driver behind the decreasing rates. The VLCC TC-rates were approximately (yearly average) 73,000 USD/day in 2008, 39,000 USD/day in 2009 and 38,000 USD/day in 2010. In 2011, as the oil price increased, the freight rates dropped even further to 25,000 USD/day. As the freight rates were depressed, the bunker price increased from 444 USD/tonne in September 2010 to 623 USD/tonne in February 2011. This forced many shipowners to operate

their vessels with daily losses (UNCTAD, 2011). In 2012 the VLCC rates have slowly increased from the end of 2011, and the one year TC-rate was 22,500 USD/day per May 8. Because of the high volatility in TC-rates for VLCCs, it is difficult to estimate whether the rates will continue to increase or not. The development in TC-rates is affected by the rest of the tanker market. These factors will be elaborated in chapter 4.

### **2.2.5 Market Participants**

To understand how the shipping markets function, we will describe the different participants the market consists of and how they interact with each other. The owners of vessels form the supply in the market. Shipowners have various possibilities when it comes to the operation of the vessel. They may operate the vessel themselves, then being both shipowner and operator, or lease the vessel to a charterer. An operator is responsible for the daily operation of the vessel. The charterer, who hires the vessel for an agreed time period or a voyage, may have all or limited operational responsibility. This implies that both shipowner and charterer may be an operator based on the contract between the two parties. We will elaborate the different types of contracts in section 2.6. To sum up, the charterer will charter a vessel from a shipowner to obtain transport for cargo in a time period or a specific voyage. The operational responsibility depends on the underlying contract (Stopford, 2009).

## **2.3 Demand and Supply**

To gain a better understanding of the shipping industry we think it is relevant to analyze the supply and demand side of the shipping markets. We can then evaluate how the drivers in these markets affect the freight rates and find out if it may be profitable to decrease speed for vessels. The “Stopford Model” will be used throughout the presentation of demand and supply (2.3.1 – 2.3.2) unless other sources are denoted (Stopford, 2009).

### **2.3.1 Demand**

According to Stopford (2009), ship demand can change quickly, sometimes by as much as 10% - 20% in a year. Ship demand is also subject to longer term changes of trend. In the last decades there have been occasions of both demand growing rapidly and demand stagnating. We will in the next section elaborate five key factors that influence the demand for sea

transport. These five factors are the world economy, seaborne commodity trade, average haul, random shocks and transport costs.

### ***The World Economy***

The world economy is considered the most important of the demand factors. This is explained by the fact that most of the demand for commodities is created by the world's industrial production.

As mentioned earlier, the fluctuations in the economy are transferred to the shipping markets. The latest example of this was in 2008 when the stock markets crashed and the world economy stagnated. These events were consequently followed by a significant decrease in freight rates in the shipping market (Strandenes, 2011). From figure 2.4 we saw that the freight rates decreased from 86,500 USD/day in the second quarter of 2008 to 38,000 USD/day in the second quarter of 2009 (Clarksons, 2012).

### ***Seaborne Commodity Trade***

In short and long term, changes in seaborne commodity trade also affect demand. Short term fluctuations are affected by seasonal changes in demand, e.g. colder weather results in increased electricity needs which give an increase in the demand for steam coal (Lun et al, 2010).

Changes in a country's export/import of various goods may create or eliminate different trade routes. Currently, China is a key demand driver for VLCCs as their import of crude oil increased by 17.4% in 2010 (Lloyd's, 2011). Relocation of production may also adjust the trade pattern because demand will adapt as production is changed.

### ***Average Haul***

Average haul refers to the mean distance that a cargo is to be hauled (Lun et al, 2010). When calculating average haul it is usual to measure demand in tonne miles, which is the total amount of tonnes transported for a trade times the average haul for the same trade.

Changes in average haul affecting demand have been seen many times in the notoriously volatile shipping markets (IMO, 2006). The closures of the Suez Canal in 1956 and 1967 are examples that led to increased average haul. Vessels had to sail around the southern cape of Africa, and the increased distance resulted in freight market booms and increased demand. These changes can be sudden and unexpected, and may be caused by reasons such as natural disasters, wars and piracy attacks. Differences in transport needs in various geographical regions may also change the average haul slowly over time.

### ***Random Shocks***

Random shocks are the fourth demand driver. Natural disasters, commodity price changes and wars are shocks which may cause instability in the economy. Financial shocks are the most important factor influencing the shipping markets. The Great Depression in the 1930s and the recent financial crisis are examples of crises that resulted in depressed rates and a downward influence on the shipping markets. The earthquake in Japan in 2011 is another example of a negative demand shock (Lloyd's, 2011).

Stopford mentions nine different political incidents which have had a significant influence on ship demand. The common denominator between these shocks is that they occur unexpectedly and that they have considerable impact on freight rates.

### ***Transport Costs***

The last driver is the cost of sea transport. Increased vessel sizes and technical improvements have drastically increased economies of scale, making sea transportation cheaper and more effective (Hummels, 2007). Economies of scale especially applies for VLCCs (Stranden, 2011).

In the short term, if a price of a commodity falls the freight rate may constitute a greater part of the total cost than the commodity itself. This especially implies to vessels transporting price volatile commodities, e.g. the VLCC segment that transports large amounts of crude oil. This may increase the freight rate elasticity of demand and will further increase the volatility of freight rates.

As we can see from these five drivers, demand for transport is complex and difficult to estimate. Significant shifts occur frequently and may cause considerable changes in the freight rates.

### **2.3.2 Supply**

In general, supply in the shipping market is rigid compared to the demand. This is especially due to time lags in the industry. In the following we will search to answer how the supply side is characterized and how it affects the cycles in the business.

#### ***The Merchant Fleet***

The merchant fleet sets the total supply in shipping and contains all vessels in seaborne trade. The supply capacity is measured in deadweight tonnes (dwt). The supply is mainly regulated through deliveries of new vessels and scrapping of old ones. The time gap from a new order to delivery is 1-4 years, and the lifetime of a vessel is approximately 25 years (hence a vessel is a long-term investment). The VLCCs constitute for a substantial part of the merchant fleet, and the supply of tanker capacity is highly dependent on the demand for oil and oil products (Frontline, 2011). With current low freight rates, the shipowners have little incentives to increase their newbuilding investments, which affect the merchant fleet (Platou, 2011).

#### ***Fleet Productivity***

As a measure of the productivity for the merchant fleet, tonne miles per deadweight is used. Tonne miles per deadweight is determined by the deadweight utilization, time in port, loaded days at sea and speed. The deadweight utilization is usually lower at the back-leg of a loop which results in reduced fleet productivity. Time in port is crucial for the productivity and is limited by the performance of terminals. Loaded days at sea are the time spent while transporting cargo. All other “unproductive” activities like when the vessel is in ballast, maintenance and off hire is hence not included in the productivity. Speed determines the time a vessel uses on a voyage. When freight rates are low, the total profit decreases and the fleet may slow steam to save money. This may reduce the capacity of tonne miles transported and to some extent influence fleet productivity. According to United Nations Conference on Trade and Development (UNCTAD), the VLCC fleet productivity has decreased since 2006 (UNCTAD, 2011).



### ***Shipbuilding Production***

The merchant fleet's growth depends on new vessel deliveries. Timing is crucial when ordering a new ship, since it usually takes between 1-4 years from an order is placed to the ship is delivered. This time lag varies with the shipbuilder's order book. In strong markets the rate of orders placed is high and hence the time lag increases, while the opposite applies for weak markets. Before the financial crisis in 2008 there was a strong market with a full order book for the shipbuilders and high freight rates (Platou, 2007). The change in demand, as a result of the crisis, decreased the freight rates. At the same time the supply was increasing as vessels ordered before the crises were delivered. This further enhanced the decrease in freight rates.

### ***Scrapping and Losses***

The merchant fleet's growth is also influenced by vessels lost at sea and scrapping of old vessels. Hence the fleet's growth is dependent of the surplus between new vessels and vessels scrapped and lost at sea. The age of the vessels is the most important factor in the scrapping decision. Other factors that influence the amount of scrapping are the current freight rates, market expectations, technical development, vessel obsolescence and scrap metal prices. Before the financial crises the earnings were high and scrapping low, but the scrapping increased when the freight rates suddenly decreased (Clarksons, 2012). Currently, there are 88 vessels operating that are built before 1997. These vessels have special surveys (explanation in section 2.4 - periodic maintenance) during 2012 and 2013, which requires maintenance of USD 3-5 million. With the today's relatively low freight rates (cash flows for shipowners), the special survey expense will probably lead to increased scrapping for these vessels. At the same time, newbuilding of VLCCs will likely not compensate for the scrapping. Hence, the VLCC portion of the merchant fleet will be reduced (BIMCO, 2012).

### ***Freight Revenues***

At last the freight rates, and therefore the freight revenues, are a driver of supply. The other supply factors are highly dependent on the freight revenues. In the short run the freight revenues regulate capacity e.g. through reduced steaming speed (Lun et al, 2010). However, in the long run the freight rates influence improvements of the industry's services and generate cost reductions. An example of long run adjustments is the 1970s oil crises and the new fuel efficient ship design that followed in the wake of the crises. We observe the same

situation the last years after the financial crisis, with relatively low freight rates. The freight rates are dependent on the balance between demand and supply in the market. High freight rates increase supply and investments, while the contrary applies to low freight rates (Tenold, 2012).

## **2.4 Costs**

The costs in shipping are divided into operating costs, periodic maintenance costs, voyage costs, cargo handling costs and capital costs. These costs can give us a more expository description of the market economics.

*Operating costs* are the current running costs day-to-day for a vessel. Principally, the operating cost consists of maintenance, routine repair, administration, manning costs and insurance. These costs vary among ships, especially the maintenance cost.

*Periodic maintenance costs* are highly dependent on the ships condition/age and legal framework that regulates the time between special surveys. The periodic maintenance cost usually takes place when a vessel has its special survey or requires larger repairs. The vessel is then dry-docked. Classification societies demand periodic maintenance to issue certificate of seaworthiness which is a requirement to sail. In general there are surveys every other year, and renewal of certificates every fourth year.

*Voyage costs* are costs related to a particular voyage. These costs are separated into fuel/bunker costs, port charges, canal dues, tugs and pilotage. Bunker costs amount for the largest portion of the voyage costs. The high bunker prices in the 1970s enforced the industry to design more fuel efficient vessels. For a large vessel the bunker cost may constitute 75% of the voyage cost (Ronen, 2011). Shipping companies cannot determine bunker prices, but they can influence their fleet's fuel consumption by adjusting the operational speed.

*Cargo handling costs* are connected to loading and discharging cargo. The cargo handling costs have been reduced through PSD and containerization.<sup>4</sup> We can divide the cargo handling costs into loading costs, discharging costs and stowing costs.

---

<sup>4</sup> For explanation of PSD, see section 1.4.

*The capital costs* are, in contrast to the other costs, dependent on the chosen risk profile and financial structure of the shipping company. Hence, it is not connected to the operation of the vessel. It includes interest, debt payments and dividend to shareholders (Stopford, 2009).

## **2.5 Risks**

Shipowners, charterers and operators face various types of risk in the shipping industry. In this section we will highlight some of the most important ones and elaborate how these affect the different parties.

*Market risk* affects all actors in the shipping industry and is explained by the cyclical fluctuations of the freight market and how these influence revenues and asset prices. High freight rates impose higher costs for charterers and higher earnings for shipowners. On the other side, low rates over time might lead to insolvency for shipowners. The freight rates are strongly correlated to the value of vessels and a shift in freight rates may therefore affect the owner's balance sheet. Weaker balance sheet may increase interest costs on loans or lead to breach of covenants bound to a loan (Stopford, 2009).

*Operating risk* mostly affects the operator of a vessel. This includes risks due to off hire because of mechanical breakdowns, vessel unemployment, damage to third party property or volatility in bunker prices (Stopford, 2009). Failure to control operational risk may affect the company. An extreme example is the Exxon Valdez oil spill in 1989. The accident had serious environmental consequences, requiring Exxon to cover costs in excess of USD 4.3 billion (Exxon Mobile, 2012).

*Financial risk* refers to interest rates, foreign exchange rates and cost of capital. Changes in interest rates may affect the shipowner through changes in profits and liquidity. Larger increases may expose the company to distress and in worst-case result in bankruptcy. If the cash flow, debt or equity is in different currencies, the company may be vulnerable to changes in foreign exchange rates (Stopford, 2009).

The last risk, *the political risk*, refers to consequences of events such as the closure of the Suez Canal. Because the vessels had to choose different and longer routes, the consequences were higher revenues for shipowners and higher costs for charterers. Other risks may be

regulatory changes, as tax legislations and flag rules. The risks are hard to forecast, and the results can be severe for the industry (Stopford, 2009).

The difficulty of forecasting risks and the potential costs that some of these risks may constitute, make it important to reduce the risk factors. Shipowners have various instruments for risk reduction. Freight rate derivatives reduce the freight market risk, while operational risk can be reduced through indemnity insurance and hull and machinery protection. The bunker cost, interest rates and currency fluctuations can be hedged by using various derivatives. It is worth mentioning that by reducing the risk, the potential profits might also be reduced (Stopford, 2009) (Kavussanos & Visvikis, 2006).

## **2.6 Contracts**

As elaborated earlier, the freight rate is a mechanism linking demand and supply in the shipping market. The balance of vessels and cargo available in the market is established by the negotiation of freight rates between shipowners and charterers. To provide a wider understanding of the shipping markets, we will now present four different types of contractual agreements.

In a *voyage charter* the shipowner contracts to carry a specific cargo for a vessel at a negotiated freight rate. The rate is based on the current spot freight rates per tonne. The charter party describes all relevant terms concerning the contract and if it is not completed there will be a claim. In this agreement the shipowners bear all of the above-mentioned costs and risks, except the cargo handling costs (Stopford, 2009).

In a *Contract of Affreightment (CoA)* the shipowner agrees to carry a series of cargo for a fixed price per tonne. This type of agreement is equal to a series of voyage charters over a particular time period. This reduces some market and operational risks, because the shipowner has increased flexibility when it comes to the transportation of cargo (Stopford, 2009).

*Time charter (TC)* is an agreement which gives the charterer full operational control of the ship, including the voyage and cargo handling costs. The shipowner will on the other hand pay the capital costs, periodic maintenance costs and operating costs. In other words, the charterer who operates the vessel decides where to go and which cargo to load. By doing this

the shipowner will transfer some costs, responsibilities and risks to the charterer. Because the shipowner now knows their primary costs they can prepare a ship's budget within a specified time. The contract seems simpler than it is; TCs are complex and includes risks for both shipowner and charterer. The risk for both parts is a result of their long term charter commitment in a volatile freight market (Stopford, 2009).

The last contractual agreement is the *bare boat* charter. This is a contract where a company has full operational control over a ship, without owning it. The charterer pays all operating and voyage cost, while the shipowner pays the financial expenses. Often this type of charter is just an investment and the owner may be a financial institution leaving all costs and risks to the charterer (Stopford, 2009).

For VLCCs, spot charters (voyage charters) are most common. It is difficult to estimate how many vessels that are chartered out under which contracts, but in general the VLCC-market is based on single voyages. As an example, Frontline ltd, the owner of the world's largest private tanker fleet, has 75% of their VLCCs in the spot market (Kollenborg, 2012).

### 3. Theoretical Basis and Introduction to Speed Optimization

We will in this chapter present the theoretical framework used to describe the potential impact slow steaming has on the shipping market. To be able to estimate if slow steaming is optimal for the business, we will exhibit a derivation of two speed optimizing formulas. To demonstrate the derivation we will use denotations that are briefly explained in the text. A more thorough explanation is to be found in appendix B.

#### 3.1 The Freight Rate Mechanism

The freight market links the supply and demand side of the shipping market. The freight rate reflects the balance of ships and cargoes available in the market and is a result of the negotiation between shipowners and charterers. If the supply of ships is high, the freight rates will be low. On the other hand, if the supply is lower than the demand, the freight rates will consequently increase. The adjustment mechanism happens all the time, trying to bring demand and supply into balance (Stopford, 2009).

##### 3.1.1 Supply Functions

The supply function is shaped as a J-curve and is often known as the “hockey stick” because of its shape. The curve describes transport volumes the shipowner provides at different freight rates.

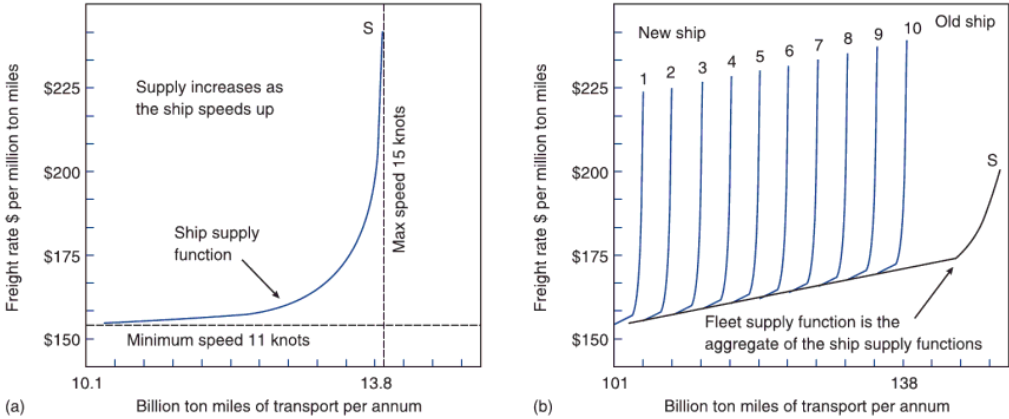

Figure 3.1 a) and b) Supply Functions (Stopford, 2009)

The vertical axis in figure 3.1 a) shows the freight rate per million tonne miles, while the horizontal axis shows billion tonne miles of transport per annum. We can see that the supply function increases exponentially with the freight rate. The supply function shows that if the

freight rate falls below 155 USD/mtm the ship is unprofitable and the vessel goes into lay-up. If the rate increases above 155 USD/mtm the vessel steams at lowest viable speed to save fuel (11 knots). At this point a vessel supplies 10.1 billion tonne miles (btm) of transport per year. At higher freight rates the vessel speeds up until the rate reaches 220 USD/mtm, where the ship reaches its full speed level at 15 knots, providing 13.8 btm per year. We see from the figure that increased freight rates will provide the market with extra supply because the vessels increase speed at higher freight rates.

Further, we can look at a fleet of ships in b) and see how the market adjusts to the supply. The supply curves of individual ships constitute the fleet supply curve. The vessels have different layup points depending on their varying age and efficiency, e.g. ship 10 has a higher lay-up point than ship 1. Naturally, the layup point is affected by the operating cost. In addition, vessels move in and out of service responding to the freight rates. On a long term basis the owner can build more efficient ships to increase the supply (Stopford, 2009).

### ***Defining the Supply Curve***

We can define the supply curve briefly by using economic theory. If we assume that the market is perfectly competitive, the profit is maximized by operating the vessel at a speed where the marginal cost equals the freight rate. This can be defined with this equation:

$$v_{opt}^n = \sqrt{\frac{p_{FR}}{3p_F k D}}$$

Here,  $v_{opt}^n$  is the optimal speed for  $n$  vessels,  $p_{FR}$  is the freight rate,  $p_F$  is the price of fuel,  $k$  is the ship's fuel constant and  $D$  is the distance. This is defining the shape of the supply curve. However, the function is more complex than this speed/freight relationship. Supply responds to the freight rates. The freight rates are affected not only through speed, but for example forecasts of freight rates may influence the supply decision for the shipowners (Stranden, 2011).

### 3.1.2 Demand Functions

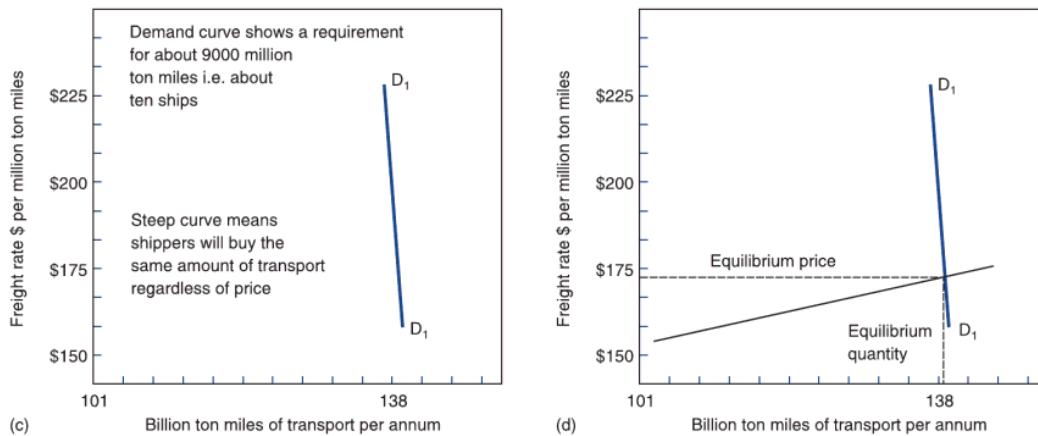

Figure 3.1 c and d) *Demand Functions*

(Stopford, 2009)

The demand function illustrates how charterers adjust to changes in  $p_{FR}$ . We can see from 3.1 (c) that the demand curve is almost vertical. This inelastic curve can be explained by the lack of alternatives in this type of transportation. The charterer is dependent on shipping cargo, and because it is difficult to get a transportation substitute, they must ship regardless of cost.

In figure 3.1 d) we see the equilibrium between supply and demand. At the equilibrium price of 170 USD/mtm the charterers are willing to hire ten ships and the owners are making ten ships available.

### 3.1.3 Equilibrium and Time Frame

The equilibrium price is given by the intersection between the supply and demand curves (Lun et al, 2010). To understand how the freight rates fluctuate we need to take the time frame into perspective. Both current and future expectations are reflected in the prices. We will now describe the differences between the equilibrium in the short and long run.



## Short Run Equilibrium

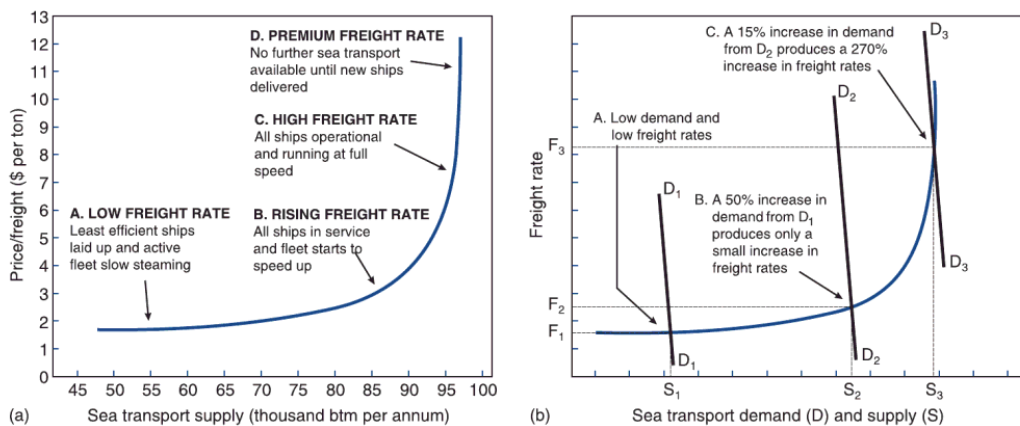

**Figure 3.2 a) and b)** Short run Freight Rate Equilibrium

(Stopford, 2009)

In the short run prices change rapidly and the owners and charterers respond to price changes through alternative courses of action. These may be reactivation of vessels, lay-up or changed operation speed. Figure 3.2 b) illustrates three scenarios how freight rates are determined in the short run. In the first scenario, A, the demand and hence the freight rates are low.  $F_1$  ( $F_2$ ) gives us the freight rate at scenario A (B), and so on. If demand increases to B, ships will be taken out of lay-up. This implies that the supply increases, and further that the response in the freight rates will not be as great as it could have been with a static supply. If demand further increases marginally to C, and the oldest ships are already taken out of lay-up, the effect will be higher freight rates. The figure (3.2 b)) shows how a 15% increase in demand from B will increase the freight rate with 270%. The charterers' willingness to pay will increase as long as the dependence of transport is crucial (Stopford, 2009).

## Long Run Equilibrium

In the long run, the adjustments to the economic cycles are through scrapping of old vessels and deliveries of new vessels. The mechanism in the market is quite simple to explain, but hard to predict (Stopford, 2009). As freight rates decrease, the second hand value of vessels will decline until it eventually reaches the scrap price. When the second hand value is equal to the scrap price the ship will be scrapped. With a vessel scrapped and permanently withdrawn from the market, supply is reduced. If the freight rates recover, the second hand value will increase. This can be explained by the increased potential income from an additional vessel. Shipowners are willing to invest more in a second hand ship available today, to be able to

exploit the additional cash flow from increased rates (Beenstock, 1985). When the market is in a recovery, there will normally be more buyers than sellers, thus it will increase the price of second hand vessels (Tenold, 2012).

We have in the first part of chapter 3 looked at how supply and demand are affected by the freight rate. As illustrated in section 2.2.3 and 2.2.4, today’s market is characterized by high bunker price and low freight rates. Since the bunker price will be of importance to our calculations, we will in the following chapter look at how higher bunker prices may affect the tanker shipping segment.

### 3.2 The Effect of Higher Bunker Prices

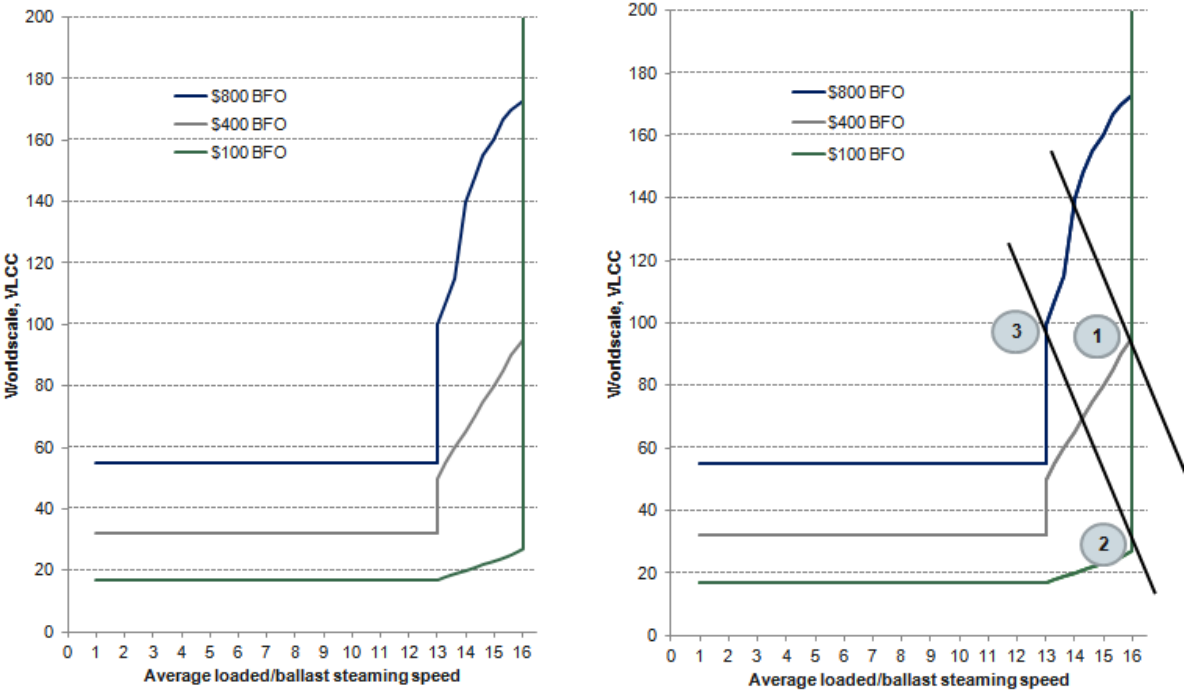

Figure 3.3 a) and b) *Slow Steaming Curves* (Strandenes, 2011)

We can use the figures above to explain how bunker prices may affect the speed of vessels, as well as the freight rates. As elaborated earlier in the dissertation, there is a correlation between oil price and bunker price, see figure 2.3, hence the price of oil will affect the shifts in supply and demand.

From figure 3.3 a), different slow steaming curves are elaborated at various bunker price levels. Firstly, we assume a bunker price of 100 USD/tonne. At a WS15 the owner gets the ship out of lay-up.<sup>5</sup> If the WS increase to 22, the figure shows that optimal speed is equal to full speed. This was the situation before the oil prices boosted around 2003-2004. When the bunker price increases the supply curve will become less J-shaped, or look less like the “hockey stick” (Devanney, 2009).

In the new supply curves the owner will speed less up for a given increase in spot rates or WS, because of the increased bunker price. At a bunker price of 800 USD/tonne, the owner requires a WS200 to steam at full speed. Consequently, the vessels speed up/down as a response to the spot rate and the given bunker price. Every industry player wants to maximize profit (and minimize costs). Thus, we see that with high bunker prices, the vessel must be compensated with high WS rates to make it profitable to speed up.

The effects of an increase in the oil price can be explained in figure 3.3 b). If the oil price suddenly increases, the demand for oil will fall, moving from 1 to 2. Consequently, the transport need for oil will decrease. The freight rate will start to fall because supply exceeds demand. Since the bunker price correlates with the oil price, the bunker price is increasing as well. High bunker price and low freight rates make it more profitable to slow steam. This will decrease the supply side and balance supply and demand again. The supply curve shifts up to the left and gets more freight elastic. In the new equilibrium 3, vessels speed at 13 knots, and because of the shifted supply curve, the freight rate will increase relatively to point 2. Depending on the supply shift, the freight rate may end up at a higher level than the initial equilibrium (Strandenes, 2011).

From a theoretical perspective we observe that the market situation today, with higher oil prices and lower freight rates, gives larger incentives to slow steam than earlier.

### **3.2.1 How Higher Bunker Prices Affect VLCC Spot Rates**

As the bunker price increases, the transport cost naturally increases as well. Under perfect conditions, the higher transport costs would be reflected in the spot market freight rates. However, shipowners claim they are not completely compensated for the higher bunker cost.

---

<sup>5</sup> For explanation of WS, see section 1.4.

The contrary was stated in the Platou Report from 1979, where Victor D. Normann and Tor Wergeland tried to answer the headline question. Their answer still holds, and in the following we will try to explain why shipowners in fact could gain from higher bunker prices (RS Platou, 2012).

A shipowner will optimize speed by comparing the cost and the potential extra income of increasing the speed. The extra income equals the extra cargo the vessel can carry per year at higher speed, while the additional cost is the increased fuel consumption multiplied by the price of fuel. If both fuel prices and freight rates increase 100%, the optimal speed will remain unchanged. This is given an inelastic demand for transport and a no changes in lay-up.

However, as bunker prices increases and freight rates remain the same, the optimal speed is reduced, which results in reduced transport capacity. To keep the transport capacity the same, the speed must be above the optimal speed. Even though the trend in operational speed has been declining since 2008, vessels are still sailing on a service speed above the optimal speed (RS Platou Markets, 2012).

The question is whether the shipowners can choose the speed or not. Naturally the charterers have an impact on the speed. Some years ago the charterers actually demanded full speed at the laden leg. As the bunker prices have increased by approximately 300% the last years (figure 2.2 and 2.3), the charterers have accepted lower speed. The lower speeds (speed < 13 knots) are within the more horizontal part of the speed/consumption curve (see figure 2.1). Optimal speed for the charterer takes into account the capital cost of the cargo. Because of other incentives the charterer's optimal speed will be higher than the shipowner's optimal speed (Platou, 2012). This will later be reflected in the difference between the Haugen model (with financing cost of cargo) and the Meyer model (without financing cost of cargo).

Briefly summarized; higher bunker prices will increase the operating cost of vessels, which then may change the market supply curve leading to decreased supply. The result may then be higher freight rates, which may increase more than the initial increase in operational cost. In total we see that shipowners may be able to gain from an increase in bunker prices (Platou, 2012). This is in accordance with what we found in section 3.2.

As mentioned, slow steaming is a way to quickly adjust the supply in the short run. Shipowners will try to minimize costs through slow steaming when the freight rates are depressed or the bunker price is high (or both). There are different ways of calculating optimal speed based on the current freight rates. This leads us to the next part of chapter 3, where we will derive two models to calculate the optimal speed.

### **3.3 Optimal Speed – Two Models**

In the following we will derive two models to calculate the optimal speed for VLCCs, the Haugen and the Meyer model. To better understand the effects of slow steaming, understanding the physical background in shipping is necessary. A detailed explanation is given in the appendix A, while we in the subsequent will briefly explain the essence. Even though the Meyer model is made for container shipping, it applies to the tanker segment as well.

#### **3.3.1 The Haugen Model**

In this section, we will present the first model to calculate the optimal speed for VLCCs. This model is called the Haugen model, as it is developed by Petter Haugen in DNB Markets (world's largest shipping bank). The model is based on a ship's resistance, a speed/consumption model and the financing cost of the cargo. To get a better understanding of the underlying components of the Haugen model, we will in the following present the components one by one. Thereafter we will show the derivation of the Haugen model for optimizing speed, with the presented components as a basis.

#### ***Resistance and Propulsion***

A ship's resistance is usually divided into three source-resistance groups (MAN-engines, 2011).

1. Frictional resistance ( $R_F$ )
2. Residual resistance ( $R_R$ )
3. Air resistance ( $R_A$ )

We can then describe a ship's total resistance as:

$$R_T = R_F + R_R + R_A$$

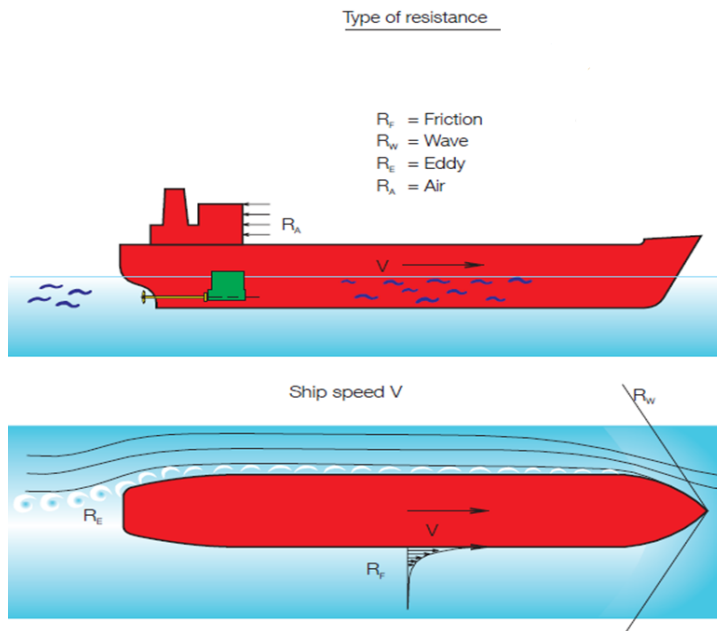

**Figure 3.4** A Ship's Resistance

(MAN, 2011)

The resistance is dependent on the ship's speed. This relationship is described with function (1). Here  $a_F$ ,  $a_R$  and  $a_A$  are parameters for resistance. They respectively reflect the frictional, residual and air resistance.

$$\begin{aligned} R_T &= R_F + R_R + R_A \\ &= [a_F + a_R] \cdot v^2 + a_A \cdot v \end{aligned} \quad (1)$$

If the ship should travel a distance  $D$  at a constant speed  $v = D/t$  against this resistance ( $R_T$ ), a work equal  $W_R = R_T \cdot D$  is required. Further we can find the power needed to travel at the speed  $v$  in the time  $t$ . This is  $P_R = W_R/t = R_T \cdot v$ . We now insert the formula describing the power needed into (1):

$$P_R = [a_F + a_R] \cdot v^3 + a_A \cdot v^2 \quad (2)$$

This is a vessel's power requirement which depends on the speed,  $v$ . The formula gives us a relationship between speed and required power that increases exponentially. The power requirement is of course dependent on the coefficients  $a_F$ ,  $a_R$  and  $a_A$ . These are not consistent

as a consequence of many exogenous variables, for example fouling and varnish conditions that increase the frictional resistance. Time and steaming speed are particularly important in determining these variables ( $a_F, a_R, a_A$ ), and hence the relationship between power and speed. These changes (e.g. fouling) are hard to measure, and we will therefore assume that they are constant. The engine load is the load on the engine in percentage of its maximum output.

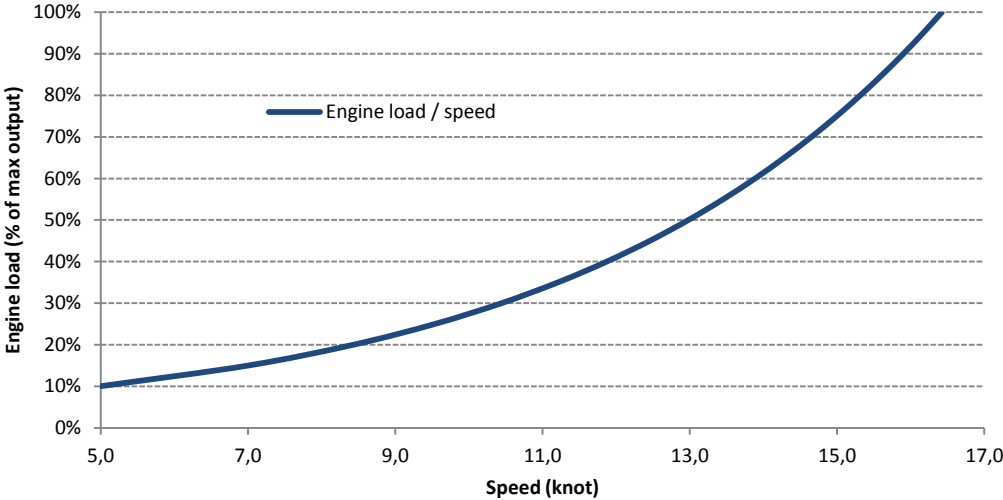

Figure 3.5 Power/Speed Relationship (MAN, 2012)

**The Cube Rule / Admiralty Formula**

Regarding to the “cube rule”, the relationship between speed and fuel consumption is proportional to the cube of the reduced speed (see figure 2.1):

$$FC = FC^* \left(\frac{v}{v^*}\right)^a \tag{3}$$

FC is the actual fuel consumption in tonne/day, v is the actual speed (knots), while  $FC^*$  is the design fuel consumption and  $v^*$  is the design speed.<sup>6</sup> The exponent denoted a, varies from vessel to vessel. This formula is also known as the “admiralty formula” (Stopford, 2009).

We will use DNB Markets’ sector report, “Mount Kilimanjaro has become Galdhøpiggen” (2011), where the importance of the speed is explained by using theoretical and actual data. Firstly, we assume that the charterer wants to minimize transportation costs, and that the charterer is price taker in both the bunker and vessel market (TC). Then the optimal speed for

<sup>6</sup> For explanation of design speed and fuel consumption, see section 1.4.

the charterer is given by the price of the vessel (TC) and bunker, and the physical relationship between bunker consumption and operational speed. Reduced speed results in increased time to complete a route. As a consequence of this, the financing cost of the cargo increases. Further it involves additional hiring cost for the charterer, while the bunker cost is reduced due to lower bunker consumption per mile. Thus this is an optimization problem.

### ***Financing Cost***

We have already mentioned lower bunker cost and additional hiring cost as a consequence of slow steaming. A third, but still significant factor in the optimal speed decision is the financing cost of the cargo. A VLCC can carry about 2 million barrels of oil at a value of approximately 250 million dollars.<sup>7</sup> As a consequence of the high cargo value for a VLCC, the cost of spending extra time at sea is high. Therefore the optimal speed should increase when the cargo value increases.

### ***Converting USD/day to USD/mile***

The industry standard to measure costs is USD/day. In the following the formula will allow variable speed, and therefore USD/mile better describes the cost. In section 4.10 we will elaborate both financing cost and this conversion thoroughly.

### ***The Derivation of the Haugen Model***

According to the Haugen model, vessel hire, financing cost of cargo and bunker cost are the three factors that influence the optimal VLCC speed. To derive the cube rule we will describe the total cost per mile as TOT, the daily time charter as TC (USD/day), bunker price per tonne as BP and financing cost as  $f$  (USD/day). Bunker consumption and speed is denoted as above, respectively FC and  $v$  ( $C^*$  and  $v^*$  for design consumption and speed).

$$TOT(v, FC) = \frac{TC}{24 \cdot v} + \frac{BP \cdot FC}{24 \cdot v} + \frac{f}{24 \cdot v} \quad (4)$$

We know from the derivation of formula (2) that  $P_R = R_T \cdot v$ . Since approximately 90% of the resistance is frictional for large vessels (MAN, 2011), we will simplify formula (2) by setting the total resistance equal the frictional resistance:

---

<sup>7</sup> The cargo value is found by assuming an oil price of USD 125 per barrel.



$$P_R = vR_T \quad (5)$$

Further, the frictional resistance,  $R_T$ , can be described as:

$$R_T = a_F \left( \frac{1}{2} \rho v^2 \right) A_S \quad (6)$$

$a_F$  is still a parameter for the frictional resistance,  $v$  is the speed,  $\rho$  is the density of the water and  $A_S$  is the wetted area of the hull.<sup>8</sup> The part in brackets in formula (6) is Bernoulli's law. Bernoulli's law describes liquids motion by an equation that expresses the relationship between pressure, density, velocity, gravity and acceleration (Calvert, 2000). This equation is only used in formula (6); hence it will not be further elaborated in our dissertation.

If we denote the total friction with a constant,  $k_0$ , and combine formula (5) and (6) we get:

$$P_R = k_0 v^3 \quad (7)$$

We know that the power needed to get propulsion,  $P_R$ , is proportional to the power from the engine and hence the fuel oil consumption (tonne/day).

$$FC = k_1 v^3 \quad (8)$$

$FC$  is still the fuel consumption, while  $k_1$  is a constant. Equation (8) gives us that the fuel consumption (tonne/day) is proportional with the speed to the power of three. This is basically a simplification of the cube rule. The equation is the physical foundation of our optimization problem. According to the main engine maker, MAN, the power is 3.2 “for low-speed ships like tankers (...)” (MAN, 2011). We will use 3.2 in our calculations, but MAN's power of 3.2 can only be used in a gap of +/- 5% from the service speed for a VLCC. With a power of 3.2 the fuel consumption will be denoted:

$$FC = k_1 v^{3.2} \quad (9)$$

---

<sup>8</sup> The wetted hull is the part of the hull below the waterline.

Since the constant  $k_1$  is dependent on the speed, this is a simplification from reality. As the speed increases, so does the propeller efficiency and wave resistance (MAN, 2011). The power will then deviate from 3.2. This problem could be avoided by applying a number lower than 3.2. This would create another problem with the model. With a power of less than 3, the effects on bunker consumption from reduced speed when the initial speed is high would be underestimated. Since the exponent is dependent on the speed it is better to parameterize the formula, so the power depends on the speed chosen. This is possible by using Newton's method.<sup>9</sup> Thus, we solve equation (9) with regard to the speed with Newton's method (Dundas, 1999):

$$FC = k_2 k_3^v \quad (10)$$

where  $k_2$  and  $k_3$  are constants.

In this parameterization we first estimate  $k_1$  by solving (9) with a given speed and consumption relationship for the service speed. Further we find  $k_3$  by solving (10) for a positive and negative divergence from the service speed. We assume that the power of 3.2 in equation (9) hold in this interval, and that  $k_2$  is constant in the same interval.  $k_2$  is then found by substituting the service speed combination into (10):

$$k_1 = \frac{FC}{v^{3.2}} \quad (11)$$

$$k_2 = \frac{FC}{k_3^v} \quad (12)$$

$$k_3 = \left( \frac{FC_{low}}{FC_{high}} \right)^{1/(v_{low}-v_{high})} \quad (13)$$

$v_{low}$  and  $v_{high}$  are respectively the speed levels at +/- 1% perturbation of initial conditions in order to parameterize the model.  $FC_{low}$  and  $FC_{high}$  are therefore the fuel consumption at  $v_{low}$  and  $v_{high}$ .

---

<sup>9</sup> Algorithm that approximates the value of a function by its tangent line (Dundas, 1999)

As an example, Clarksons data estimates that a VLCC operating at 15.9 knots, has a bunker consumption of 92 tonnes per day (Clarksons, 2012). Then we can find  $k_1$ ,  $k_2$  and  $k_3$  by using formula (11), (12) and (13). When the speed ( $v$ ) is 15.9 knots, and the associated fuel consumption (FC) is 92 tonne/mile,  $k_1$  is 0.01328. If we use a 1% perturbation from 15.9 knots, we can first calculate  $k_3$  to 1.2293 and finally  $k_2$  to 3.7497.

We now have a formula that can parameterize the fuel consumption (FC). Earlier we presented a formula that showed the total cost per mile (TOT), given the speed ( $v$ ) and fuel consumption (FC) (equation (4)). If we now substitute equation (10) into equation (4), we get an expression for the total cost per mile as a function of the speed alone.

$$TOT(v) = \frac{TC}{24 \cdot v} + \frac{BP \cdot k_2 \cdot k_3^v}{24 \cdot v} + \frac{f}{24 \cdot v} \quad (14)$$

To optimize the speed we differentiate (14) with respect to the speed:

$$\frac{\partial(TOT(v))}{\partial v} = \frac{v^2 BP k_2 k_3^{v-1} - BP k_2 k_3^v - TC - f}{24 v^2} = 0 \quad (15)$$

It should be mentioned that this equation does not have any quantitative solution as long as the fuel consumption is expressed as it is in formula (10) above. By using a first-order approximation from Newton's method we solve this numerically.

We will later show the optimal speed for different combinations of bunker prices and TC-rates. In the following section we will present an alternative formula to find the optimal speed.

### 3.3.2 The Meyer Model

To get a better qualitative basis for our analysis, we will present an alternative model to calculate the optimal speed. We will in the following elaborate an alternative formula to determine if slow steaming is optimal. We will use the formula presented by Meyer et al (2012) as a basis, hereafter called "The Meyer model". This model was originally developed to the container shipping segment, but with small adjustments we believe it can apply to the tanker shipping segment as well. We will elaborate which parts of the model that are not

applicable for tanker segment as they are presented. Assumptions to this formula are listed in appendix E.

### ***Fuel Consumption***

A ship's fuel consumption is dependent on a variety of different factors that are difficult to estimate. The efficiency of the engine, driveshaft, propeller and hull design have a substantial impact on the fuel consumption and the resistance (Gudehus, 2010). According to Gudehus (2010), the fuel consumption  $FC_{nm}$  per nautical mile (nm) can be presented as:

$$FC_{nm} = FC_{min} + C_F \cdot v^n \quad (16)$$

$FC_{min}$  is the minimum consumption for a given engine type to have any forward thrust at all, while  $C_F$  is a fuel consumption parameter. The formula expresses that the fuel consumption increases exponentially with speed. The exponent ( $n$ ) is, like in the Haugen model, 3.2. The most common relationship to describe the fuel consumption is the cube rule (see section 3.3.1). Because of great fluctuations in fuel consumption, a ship's fuel consumption should be individually based upon empirical observations (Brown, et al., 2007).

### ***Lubricating Oil***

In the original formula by Meyer et al, the lubricating oil combusted in the engine is accounted for. However, there are differences in the cost structure between the tanker and container shipping segments. In the tanker segment, the lubricating oil is a part of the operational cost (see costs 2.4). The operational cost is estimated to be constant with regard to speed, and is therefore not determining factor for speed optimization. Additionally, there are no evidence that the combustion of lubricating oil in the engine correlates with the bunker fuel consumption. We will therefore not include lubricating oil in our adaption of this formula for VLCCs.

### ***Transport Performance***

Maximum transport performance is denoted  $F_S$ , while the actual usable cargo space is  $cap_{eff}$ . During the operating time period  $T_0$ , the maximum number of round trips is  $M_T$ . Then we can describe the maximum transport capacity,  $F_S$ :

$$F_S = cap_{eff} \cdot M_T = cap_{eff} \cdot \frac{T_0}{T_T} \quad (17)$$

Here  $T_T$  is the required time for a trip, which can be decomposed into time spent in harbor  $T_H$  and time spent in shipping  $T_S$ . Time spent in a specific harbor is denoted as  $t_H$ . With a distance  $D$  and speed  $v$  for trip  $i$ , the required time of a round trip can be elaborated:

$$T_T = T_H + T_S = \sum t_H + \sum \frac{D_i}{v_i} \quad (18)$$

### ***Income per Trip***

The income-structure in the tanker shipping segment is somewhat different from container shipping. To adapt the formula we will calculate the income as the product of the USD/mile and distance on a route (round trip),  $D_i$ . See appendix E for details on chosen route.

$$I = \frac{USD}{mile} \cdot D_i \quad (19)$$

From the formula for income (19), we can see that a reduction in USD/mile will give proportional loss in income for the shipping company. The optimal speed will naturally decrease as the TC-rate decreases. The industry standard to measure costs is USD/day. In our optimal speed matrices we will consequently change USD/mile to USD/day.

To be able to calculate the profit maximizing (optimal) speed, a profit function is required. Therefore, the costs per trip will be elaborated in the next section.

### ***Costs per Trip***

We have briefly introduced costs in section 2.4, but we will here elaborate these costs further. The total costs  $C_V$  include three costs.

1. Fuel cost,  $C_F$
2. Harbor costs,  $C_H$
3. Usage costs  $C_U$ , which are costs like maintenance, insurance, labor costs and capital consumption.

The cost classification in container shipping is somewhat different from the standard segregation of costs. In the tanker shipping segment, bunker cost is classified as a voyage cost rather than an operating cost. In container shipping the charterer only pays per TEU, and hence the owner pays all costs.<sup>10</sup>

We will assume that the usage cost is fixed, even though it may vary from type of hiring contract.

The Meyer model use a profit maximizing formula to find the optimal speed, and therefore port cost will be added. Hence, we will use  $N_H$  to describe the number of harbors per round trip and  $p_H$  as the average harbor price. Then we can find  $C_H$ :

$$C_H = M_T \cdot N_H \cdot p_H = \frac{T_0}{\sum t_{H,i} + \sum D_i/v_i} \cdot N_H \cdot p_H \quad (20)$$

When  $p_{F,i}$  is the fuel price for trip  $i$ , the fuel cost for trip  $i$  can be denoted as:

$$\begin{aligned} C_F &= \sum p_{F,i} \cdot FC_i \cdot D_i \\ &= \sum p_{F,i} \cdot (FC_{min} + C_F \cdot v_i^n) \cdot D_i \end{aligned} \quad (21)$$

When the maximum number of trips is  $M_T$ , the fuel cost is:

$$C_F = M_T \cdot C_F$$

---

<sup>10</sup> For explanation of TEU, see section 1.4.

$$= \frac{T_0}{\sum t_{H,i} + \sum D_i/v_i} \cdot N_H \cdot p_H \cdot C_F \quad (22)$$

Since  $C_V = C_U + C_H + C_F$ , we can write:

$$C_V = C_U + \frac{T_0}{\sum t_{H,i} + \sum D_i/v_i} \cdot N_H \cdot p_H + \frac{T_0}{\sum t_{H,i} + \sum D_i/v_i} \cdot \sum p_{F,i} \cdot (FC_{min} + C_F \cdot v_i^n) \cdot D_i \quad (23)$$

### ***Profit Optimizing Speed***

When there is a supply surplus, the profit maximizing speed equals the optimal speed given the costs. If we assume a full payload, the income for the vessel is;

$$\begin{aligned} I_V &= \frac{USD}{mile} \cdot D \\ &= \frac{USD}{Mile} \cdot D \cdot \frac{T_0}{\sum t_{H,i} + \sum D_i/v_i} \end{aligned} \quad (24)$$

The profit function gives us;

$$\begin{aligned} P_V &= I_V - C_V = I_V - C_U - C_H - C_C \\ &= \frac{USD}{Mile} \cdot D_i \cdot \frac{T_0}{\sum t_{H,i} + \sum D_i/v_i} - C_U - \frac{T_0}{\sum t_{H,i} + \sum D_i/v_i} \cdot N_H \cdot p_H - \frac{T_0}{\sum t_{H,i} + \sum D_i/v_i} \\ &\cdot (\sum p_{F,i} \cdot (FC_{min} + C_F \cdot v_i^n) \cdot D_i) \end{aligned} \quad (25)$$

We now have a formula where the profit can be maximized based on the speed for trip  $i$ . The consumption functions can be simplified by assuming the speed for a given segment  $v_i$  can be expressed as deviation from the average speed  $\bar{v}$ ,  $v_i = \bar{v} \pm \Delta v_i$ . Since the fuel consumption is higher when speed varies, the minimum fuel consumption can be set equal to the fuel consumption when steaming at a minimum manoeuvring speed that is constant. Further we will assume that a vessel has more days at sea than in harbor,  $D/v > N_H \cdot t_H \rightarrow$

$$\frac{1}{(N_H \cdot t_H + D/v)} \sim v/D.$$

Finally we assume that the freight rates and fuel price are constant during a trip. With these assumptions we can simplify formula (25):

$$P_V = T_0 \cdot \left( \frac{USD/mile \cdot D_i}{D} \cdot v - C_U - \frac{N_H \cdot p_H}{D} \cdot v - p_F \cdot (FC_{min} + C_F \cdot v^n) \cdot v \right) \quad (26)$$

To find the profit optimizing speed  $v_{opt}^p$  we then derivate (26) with respect to v and set this equal zero:

$$\frac{dP_V}{dv} = T_0 \cdot \left( \frac{USD/mile \cdot D_i}{D} - \frac{N_H \cdot p_H}{D} - p_F \cdot (FC_{min} + C_F \cdot v^n) \right) = 0 \quad (27)$$

If (27) is solved with respect to v, we find the profit optimizing speed:

$$v_{opt}^p = \left( \frac{USD/mile \cdot D - N_H \cdot p_H - p_F \cdot D \cdot FC_{min}}{p_F \cdot D \cdot (n+1) \cdot C_F} \right)^{1/n} \quad (28)$$

(Meyer et. al, 2012)

$USD/mile$  = USD per mile

$p_F$  = Price fuel

$D$  = Roundtrip distance in nm

$C_F$  = Fuel consumption parameter

$N_H$  = Number of harbors per loop

$n$  = Speed exponent

$p_H$  = Average harbor price

$FC_{min}$  = Minimum consumption at forward trust

We have now established a theoretical knowledge of optimal speed for VLCCs. In addition we have presented two models to calculate the optimal speed. Both models are dependent on the current market conditions. We will in the following chapter take a look at the current situation in the VLCC market.



## 4. The VLCC Market

In this chapter we will elaborate the VLCC market to form a basis knowledge of the tanker market before we conduct our optimization model in the next chapter. The VLCC market is very volatile, similar to other shipping markets. Since VLCCs carry crude oil, fluctuations in the oil price affect their cargo value. VLCCs are the largest and most commonly used tanker ships. This makes them more vulnerable to changes in demand because longer routes are typically affected faster by an imbalance than shorter routes (Stopford, 2009).

### 4.1 VLCC Fleet Development

Figure 4.1 shows fleet estimates for 2012e, and compares the development in deliveries, demolition and fleet. Based on actual numbers for the first quarter, we assume the same growth in deliveries and demolition throughout the year.

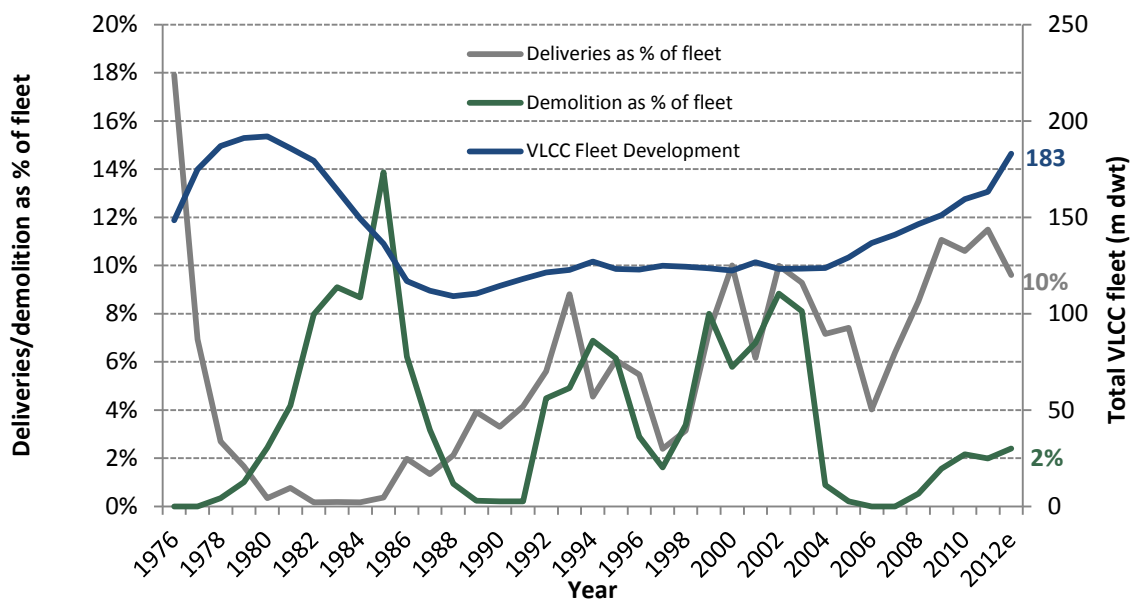

Figure 4.1 VLCC Fleet Development

(Clarksons, 2012)

From figure 4.1 we see that we have to go back to the beginning of the 1980s to find the same fleet level as today. The fleet level has increased significantly from 124 million dwt in 2004, to the estimate of 183 million dwt by the end of 2012. Our estimate shows a fall in deliveries, from constituting 11% of the fleet in 2009, 2010 and 2011, to 10% of the fleet in the end of 2012. The decrease may be a result of the decline in order book after the financial crisis in 2008, see figure 4.2. Since vessels are delivered 3-4 years after contracting, we may expect a

further decrease in deliveries in the upcoming years. We observe that the demolition level has increased, but is still fairly low compared to the mid 1980s (Clarksons, 2012).

#### 4.2 Development Order book

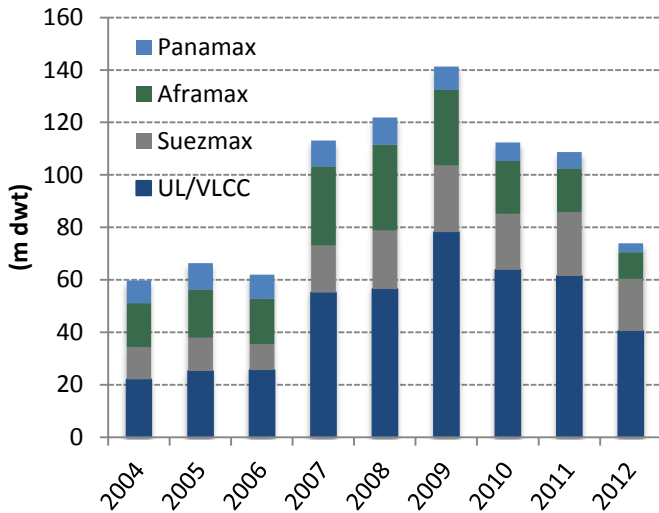

**Figure 4.2 a)** *Development Order book* (Clarksons, 2012)

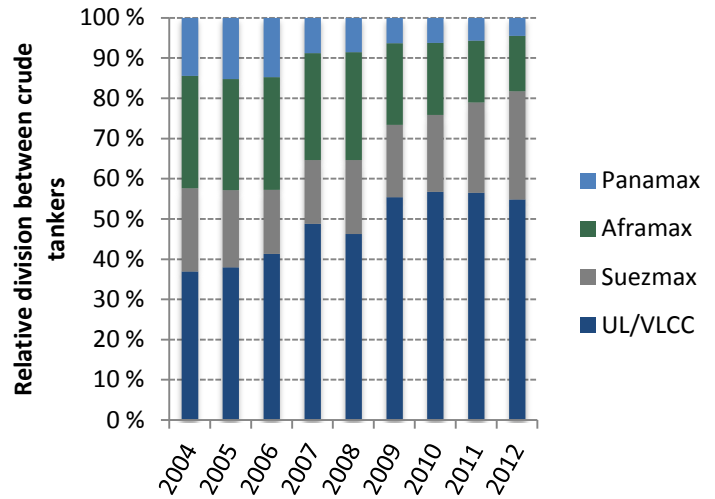

**Figure 4.2 b)** *Relative Division between Crude Tankers Order book* (Clarksons, 2012)

From figure 4.2 a), we observe that the order book in the first quarter of 2012 is almost half the size from the peak in 2009, but it is still above 2004-2006 levels.

In figure 4.2 b), we have made a relative division of the order book between the biggest crude tankers. We observe that VLCC vessels now constitute over 50% of the total order book, in comparison to 2004 when this amount was below 40%. This may be a result of an increase in longer routes and rising demand for oil in the world, creating an increased need for VLCC vessels (Clarksons, 2012).

### 4.3 Deliveries, Demolition and Order book

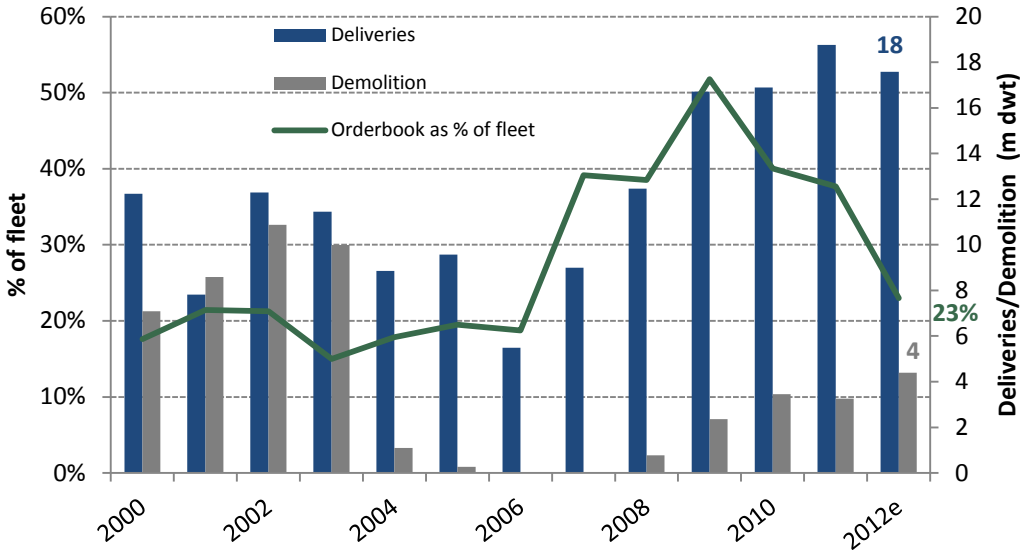

Figure 4.3 Order book as Percentage of Fleet (Clarksons, 2012)

In the figure above, the order book is estimated as a percentage of the fleet in the beginning of each year. We observe that the order book has fallen sharply from 38% in first quarter 2011 to 23% in first quarter 2012. The chart shows that estimated deliveries for 2012 is slightly down, while demolition is estimated to increase (Clarksons, 2012).

The decrease in the order book as a percentage of the fleet can be explained by figure 4.1 where we observed that the fleet is expected to grow further, and from figure 4.2 a) that there has been a decline in the order book after 2009. This gives a total negative change in the order book as a percentage of the fleet.

### 4.4 Utilization

Our utilization overview is based on modelled calculations of supply and demand from Clarksons Research Service and input from Clarksons’ oil analyst Charles Mantell. We observe that the VLCC fleet utilization has varied the last decade, from the all time high in 2004 of 100%, to today’s level at 82%. Demand declined after the financial crisis, but even though the demand picked up and has had a positive growth the last years, the supply grows even faster resulting in lower utilization.

Today shipowners may optimize speed to increase the utilization of the fleet. Lower speed will reduce the transport capacity, and if the market was in equilibrium, more ships would be demanded to perform the same amount of transport. In today's situation where there is a supply surplus, slow steaming may balance supply and demand and improve utilization of the fleet (Mantell, 2012)

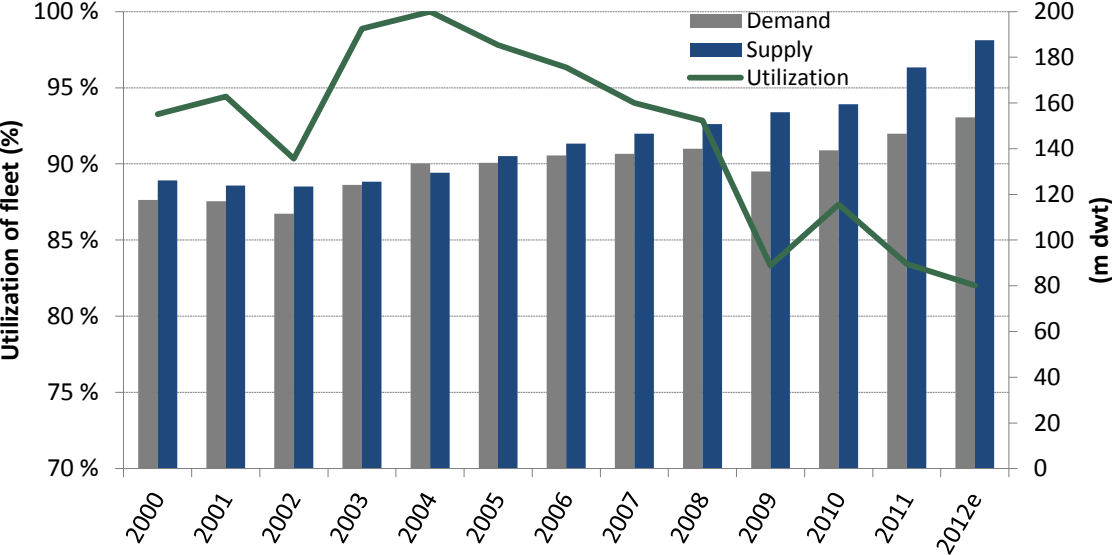

Figure 4.4 VLCC Fleet Utilization (Mantell, 2012)

It is however important to indicate that this is not a perfect fit for utilization, as certain factors are difficult to pick up in these models. For example, when demand outpaced supply in 2004, earnings for tanker owners went through the roof. As a result of this massive injection of capital and the continuation of demand growth, owners did various things to continue to try to meet available cargoes. The most important of these was speeding up ships, as the rapid rise in revenue enabled owners to comfortably offset rising bunker prices, thereby making more ships available in key regions to service demand. At the same time, ships became more efficient with vessel movement determining where to get the next cargo fastest at the best rate. Clearly, this development in vessel characteristics is not easy to pick up in the model, and is not a reflection of "unserved" demand. Another more long term element of this boom was the massive ordering of new vessels to service the demand going forward. This explains why it is a reverse situation, where supply is outpacing demand, as ships ordered after 2008 are now becoming available as demand has declined, leading to the current overcapacity (Mantell, 2012).

Clarksons’ demand model is drawn from trade data which they source from a wide variety of sources providing information on various countries' trade volumes. The trade data is then broken down by vessel type using fixtures data from their extensive tanker database. The model then utilizes the trade volume per ship type and converts the data into the deadweight of ship supply required. This is the amount of dwt required in that year to carry that volume of oil, taking into account a standard round voyage distance, speed, barrel capacity, deadweight, amongst other parameters. The process is done for each ship type and trade flow combination in each year on a more disaggregated level than is visible in their publications (Mantell, 2012).

According to DNB Markets (2012), the current tanker fleet (all tanker segments) utilization is 90%, taken slow steaming into account. If the tanker fleet had steamed at full speed, they calculate a utilization that would have been about 70%. This is in accordance with Clarksons’/Mantell’s analysis (Finansavisen, 2012).

**4.5 Development in Demand and Supply Growth**

The figure below shows that demand had a boost in 2002-2003, before it stabilized a few years later, but then suddenly fell by 9% after the crash in the financial markets. Demand is now picking up, but the supply growth is higher than demand leading to increased oversupply and lower utilization. The estimates for 2012 show that the demand and supply growth ends up close to balance with 5% and 7% growth this the year (Mantell, 2012).

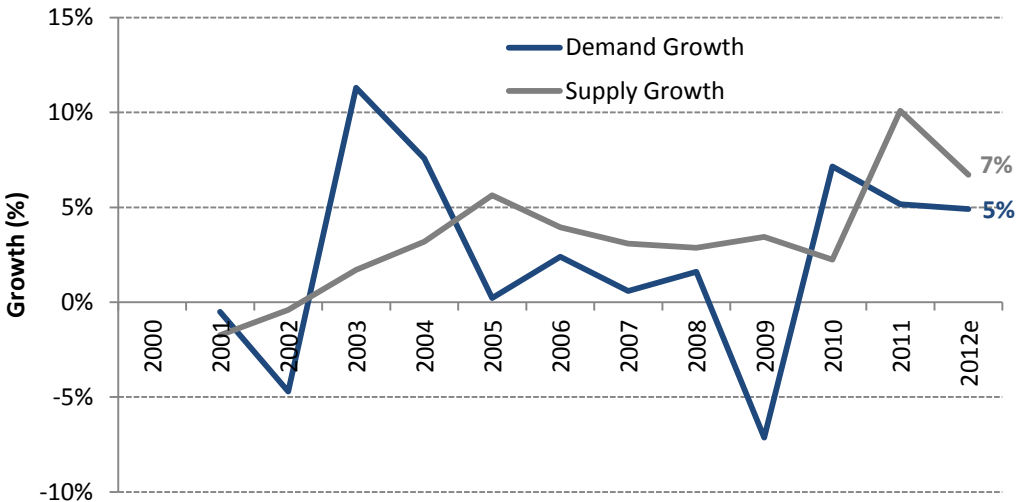
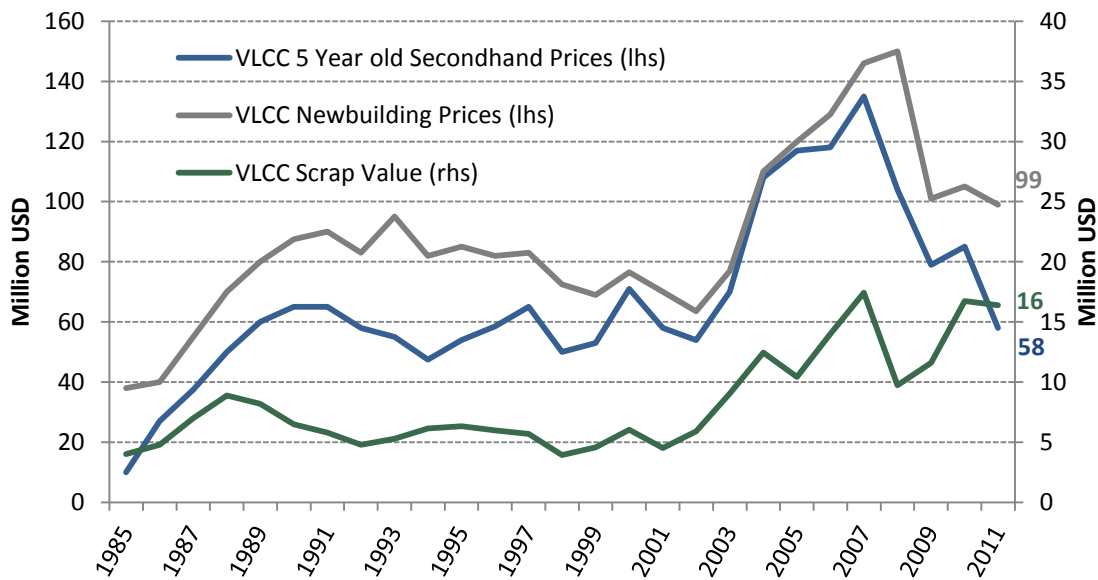

Figure 4.5 Development Demand and Supply Growth

(Clarksons, 2012)

## 4.6 Historical Development in Prices



**Figure 4.6** *Development in Prices for VLCCs*

(Clarksons, 2012)

The figure above shows that there has been high volatility in both newbuilding and second hand prices the last 25 years. Like many other asset prices, both newbuilding and second hand prices started to increase around 2003 and continued until it reached the top in 2008. In these years newbuilding and second hand prices more than doubled, but fell sharply in 2008. The prices are now at almost the same level as they were in the 1990s (Clarksons, 2012).

We observe that all values fell sharply after the crash in 2008. When newbuilding prices and second hand prices continued to fall, the demand for demolition increased because it was more profitable to scrap vessels than operating them. Because the demand for scrapping increased, the scrap values started to rise. In 2010 and 2011 the scrap prices have stabilized around 16 million USD (Clarksons, 2012).

## 4.7 Development in Scrap Value and Average Earnings

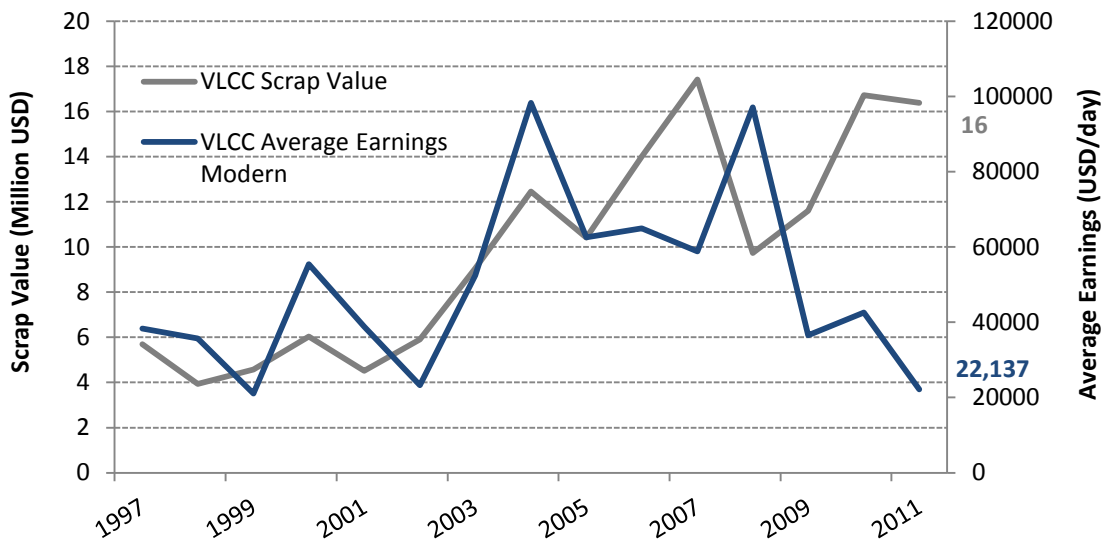

**Figure 4.7** Development VLCC Scrap Value and VLCC Average Earnings

(Clarksons, 2012)

From the figure above we see that there have been decreasing average earnings and increased scrap values since the end of 2008. These factors give higher incentives to increase scrapping activity. Higher earnings give shipowners small incentives to scrap vessels, while lower earnings and increasing scrap prices make demolition more attractive. This is in accordance with figure 4.3 where we saw that the scrapping of VLCCs has increased the recent years (Clarksons, 2012).

## 4.8 Bunker Cost Relative to TC-cost

Since bunker costs and TC-cost are crucial to determine optimal speed we feel it is adequate to see how this relationship has developed. As mentioned earlier, the oil price has risen significantly over the last years causing increased bunker costs as well. We will use average data from Clarksons Database, which is a constant bunker consumption of 92 tonnes per day over the period 1990-2012 (Clarksons, 2012).

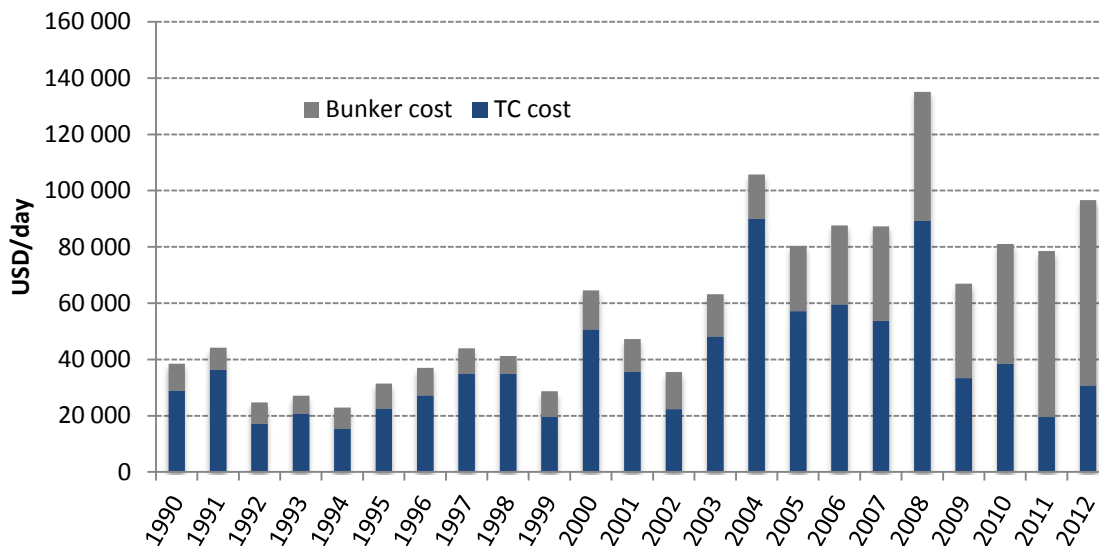

**Figure 4.8 a)** *Development of Historical Vessel and Bunker Cost* (Clarksons, 2012)

Figure 4.8 a) describes the historical development in total transportation cost. We observe that the development has been quite volatile, from under 40,000 USD/day in 2002 to the all time high level of almost 140,000 USD/day in 2008. Today's level of almost 100,000 USD/day is lower than in 2008, but higher than the average historical value of 60,000 USD/day (Clarksons, 2012).

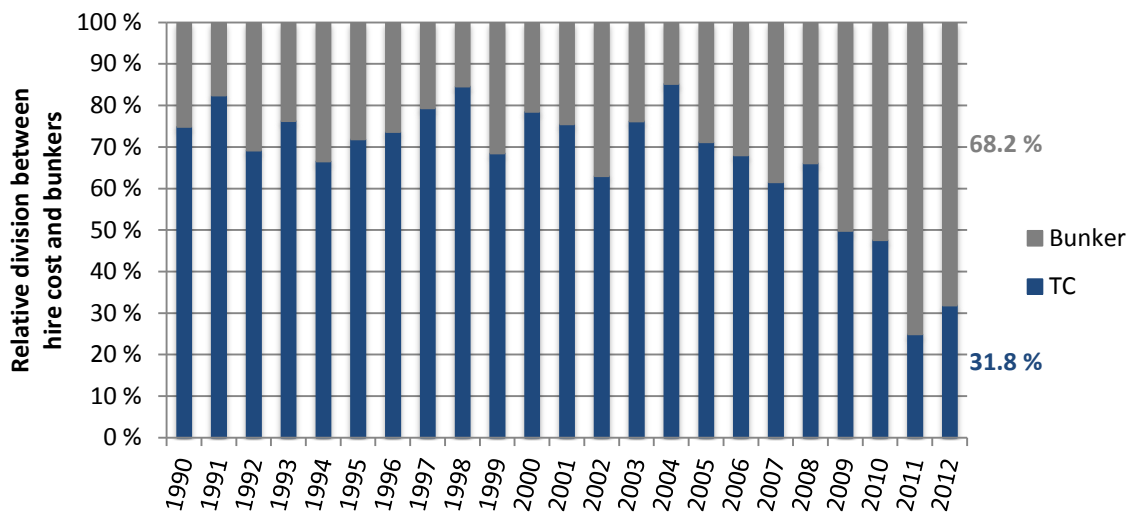

**Figure 4.8 b)** *Relative Division Between Bunker and Hire Cost* (Clarksons, 2012)

Figure 4.8 b) gives an overview of the relationship between vessel hire and bunker cost. We see that bunker cost constituted 25% of the total costs in 1990. From 1990-2005 the bunker cost was on average 25.2% of the total cost. However, the relationship changed dramatically



from 2008 to 2009, when bunker cost increased from 33.9% to 50.2% of the total costs. The increase continued and in 2012 the bunker cost today makes up over 2/3 (68.2%) of the total operating costs. Since the bunker cost constitutes a major part of the total costs, the charterers are more exposed to fluctuations in the oil price today than earlier. A further increase in oil price will make the tanker market even more vulnerable (Clarksons, 2012).

### 4.9 Converting USD/day to USD/mile

In chapter 3.2.1 we elaborated the conversion from USD/day to USD/mile. We will continue to use a normal service speed of 15.9 knots and a bunker consumption of 92 tonnes per day (Clarksons, 2012). These figures are the average from Clarkson world fleet register. As long as the same assumptions are used on both USD/day and USD/mile, the division between bunker and hire cost remains the same (Clarksons, 2012).

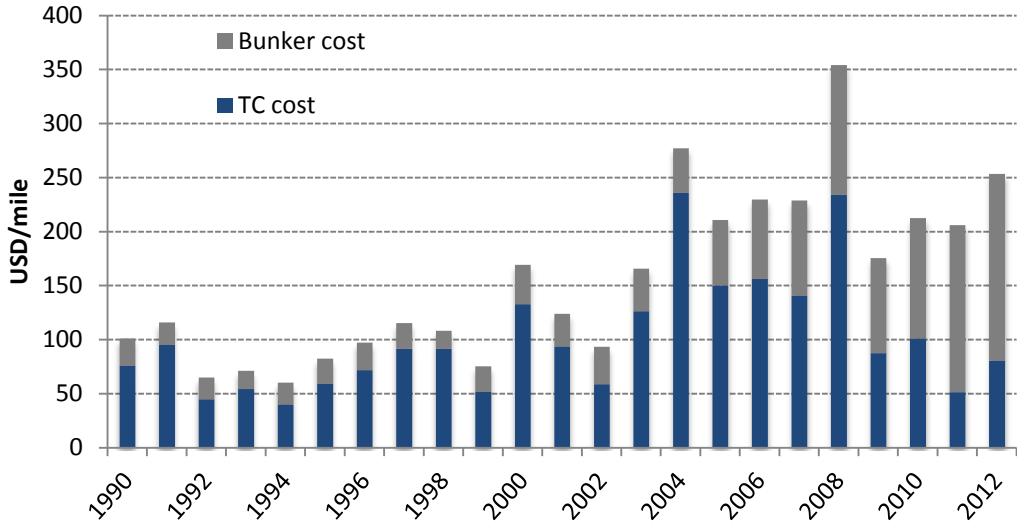

Figure 4.9 Development of Historical Vessel and Bunker Cost (Clarksons, 2012)

### 4.10 Financing Cost and Value of Cargo

As mentioned in chapter 3.3.1 the financing cost of cargo will be relevant to evaluate optimal speed for tankers. We will in this section show the development in the interest rate and value of cargo, and then show how the financing cost has developed since 1990s.

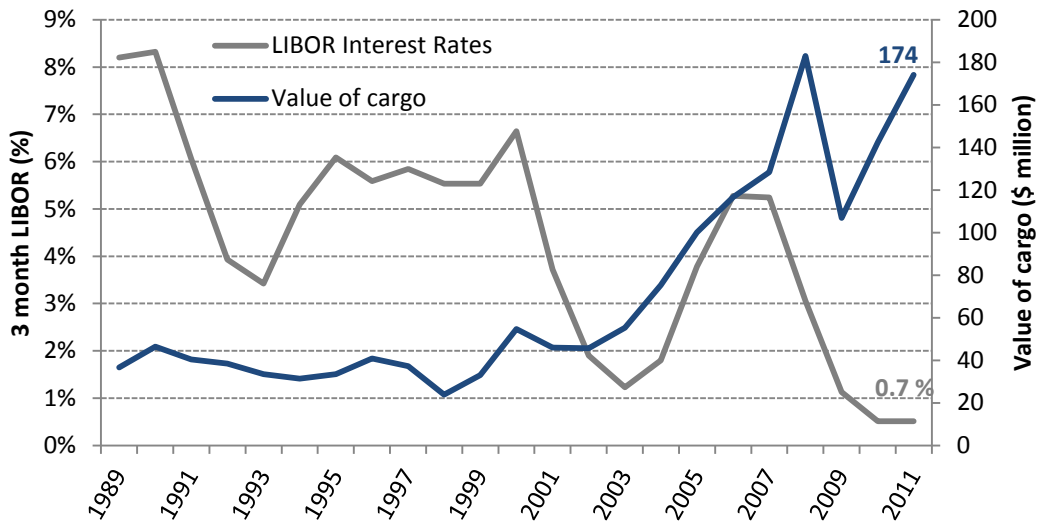

Figure 4.10 a) Historical LIBOR and Cargo Value (Clarksons, 2012)

The figure above shows the development in LIBOR interest rate and in the value of cargo. LIBOR is an average of interest rates that banks in London charge when lending to other banks. The rate is viewed as a benchmark for financing cost in the world’s financial markets and is therefore a relevant reference rate for our calculations (Klovland, 2011). The value of cargo is calculated as the oil price multiplied by 2 million barrels.

The value of cargo has mainly increased since 2000, had a dip because of the crisis in 2009, but has almost recovered to a 2008 level. The interest rate has fluctuated the last 20 years, and fell sharply after the financial crisis in 2008 and is now at an all time low level of 0.7% (May 8) (Clarksons, 2012).

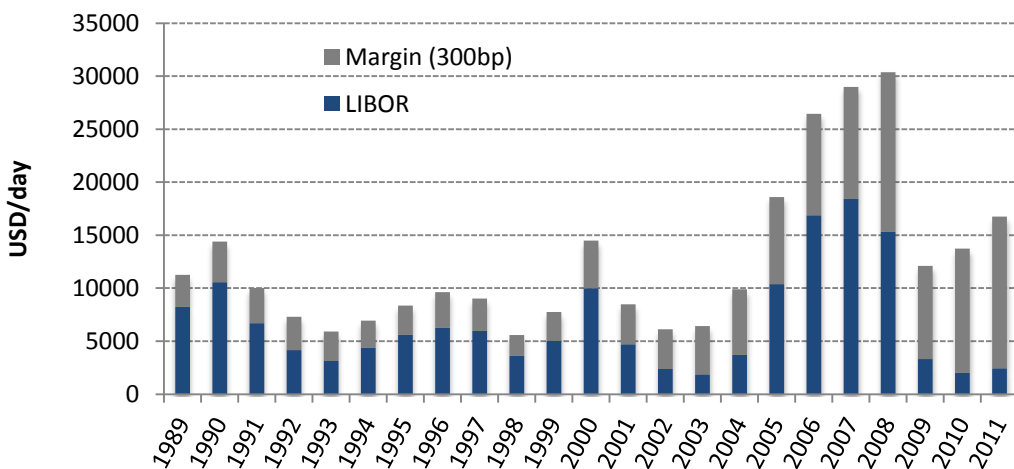

Figure 4.10 b) Financing Cost USD/day (Clarksons, 2012)

To calculate financing cost we assume the interest cost paid is represented by the 3-month LIBOR rate and a fixed margin set at 3%.

We have calculated the financing cost as the sum of LIBOR rate and margin divided with 365 days and multiplied with the cargo value. As we can see from figure 4.10 b), the financing cost varies a lot. From the last figure we observed that there are large fluctuations in both the value of cargo and the interest rates. From 2006-2008 the financing cost increased because both the value of cargo and the interest rate were high. In this period the vessels travelled on full speed, because higher financing cost justified higher speed. The financing cost fell sharply in 2009, but has picked up again the last years. Today's (May 2012) total cost of 16,750 USD/day is almost half of the daily cost in 2008. Still, this is above the historical average cost of 12,550 USD/day (Clarksons, 2012).

#### **4.11 Historical Average Speed of Vessels**

Before the financial crisis hit in 2008, no one viewed speed as a relevant factor to increase profit. For the last decades, most tankers have travelled on their normal service speed, but with increasing bunker prices and falling freight rates this has changed (Bloomberg, 2012).

To calculate historical speed we only have average speed numbers from AIS Live from 2008 and onwards. However, interviews with market actors tell us that the reported speed is lower than the actual speed since 2008. The difference may be due to the fact that AIS Live calculate an average speed of all ships at a certain time. This includes vessels in and out of ports, in canals etc. and will of course reduce the actual average speed. Therefore it is difficult to know which speed the vessels actually steam at. To compute a realistic development of actual historical speed we have assumed that the average speed of the fleet was equal to the normal service speed of 15.9 knots in June 2008. We have used the percentage change from AIS reported data to compose the actual speed development.

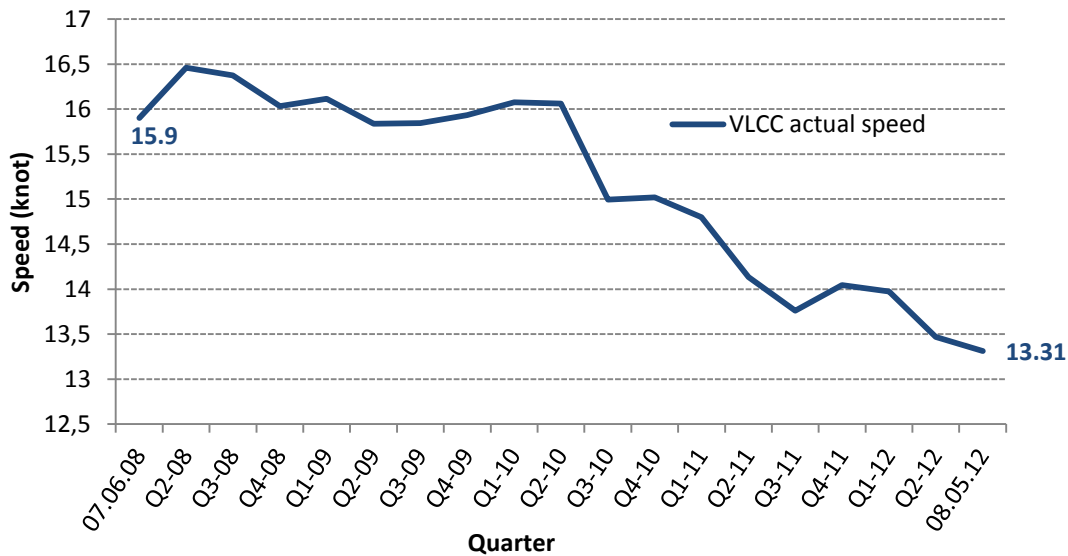

**Figure 4.11** *Historical Development in Speed*

(Bloomberg/AIS-live and own calculations, 2012)

From the figure we can see that the average speed for VLCC vessels has decreased from 15.9 knots in 2008 to today's level (May 8) of 13.31 knots. In total, the speed of the VLCC fleet has decreased by 16.3% from 2008 to 2012 (Bloomberg/AIS Live and own calculations, 2012).

We have now formed a theoretical basis, derived two optimal speed formulas and looked at the current VLCC market. With this as a basis, we will in the following chapter present our calculations of optimal speed for VLCCs.

## **5. Optimal Speed and Potential Savings**

In this chapter, we will present the results from the two speed optimizing models. Firstly, we will present and evaluate the results, before we will address possible criticism to our findings. Secondly, we will look at the average optimal speed of the two models. Thereafter, we will do a quality assessment of our results. Further, the savings from choosing optimal speed compared to full speed will be presented. Finally we will look at the increased Time Charter Equivalent (TCE) for a specific route, TD3.<sup>11</sup>

### **5.1 Optimal Speed for VLCCs**

In the following we will present the optimal speed for VLCCs, under our assumptions made in the derivation of the formulas in chapter 3.2. In addition to the assumptions made to derive the formulas, we have gathered necessary data from the Clarksons Database. The assumptions are listed in respectively appendix D and E. In the cases where the same parameters are represented in both formulas, we use the same input data. This makes the basis for comparison as equal as possible. We have used real world data from Clarksons Database as a standard of reference. For VLCCs, spot charters (voyage charters) are most common (Kollenborg, 2012). However, the VLCC spot rate has empirically been ten times more volatile than TC-rates. The first two quarters of 2012 confirms this. One year TC-rates are less volatile and should reflect the expected market conditions the next year. Additionally, TC-rates will not be affected by temporary random shocks (e.g. seasonality, Iranian embargo) to the same extent as spot rates (Cullinane, 2011). That is why we will use a one year TC-rate when calculating the optimal speed. The optimization models can be used for both contracts, since freight rates are denoted in USD/day. We will use the one year TC-rate of 22,500 USD/day, and bunker price of 700 USD/tonne from May 8, 2012.

#### **5.1.1 The Haugen Model**

Through the Haugen model we can calculate optimal speed both with and without financing cost. Since there is no cargo on the back-leg of the loop, we have calculated optimal speed for both laden and ballast. Naturally the financing cost will be disregarded when the vessel is in ballast.

---

<sup>11</sup> For explanation of TCE and TD3, see section 1.4.

## Laden

When the vessel is laden; bunker costs, TC-rates and financing cost will be of relevance. We can see from the figure below that the financing cost is crucial for the optimal speed.

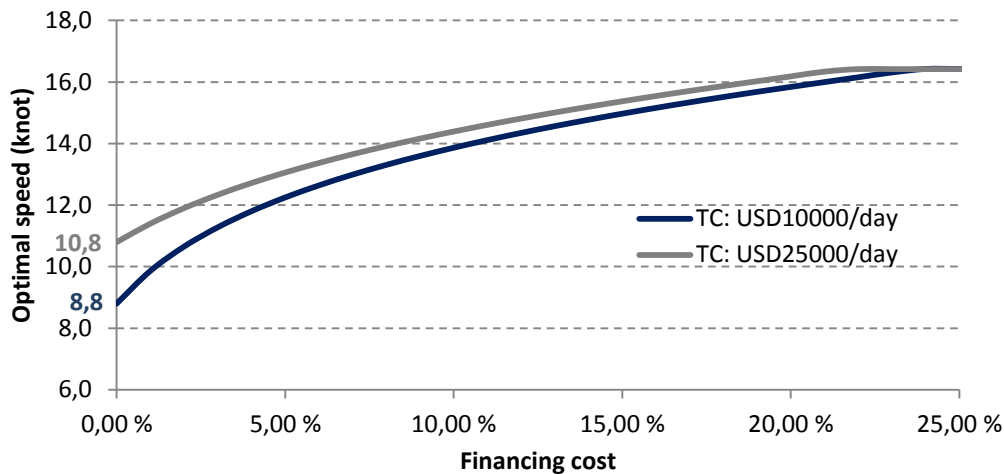

Figure 5.1 Speed vs. Financing Cost

(The Haugen Model, 2012)

The figure shows the importance of financing cost for the optimal speed. The blue and grey line represents respectively TC-rates at 10,000 USD/day and 25,000 USD/day. We observe that when the financing cost increases, the optimal speed increases. If the financing cost of the cargo was equal to zero and the TC-rate was 25,000 USD/day, the optimal speed would be 10.8 knots. In general, we observe that the impact on the speed will decline as the financing cost increases.

We have now shown how the optimal speed is dependent on the financing cost. If we include today's financing cost of 3.7% (3mth LIBOR May 8 and a margin of 3%) in our calculations, we can generate a matrix showing the optimal speed given bunker cost and TC-rates.

Bunker price	OPTIMAL SPEED LADEN																			
	TC rates [\$/day]																			
	2500	5000	7500	10000	12500	15000	17500	20000	22500	25000	27500	30000	32500	35000	37500	40000	42500	45000	47500	50000
100	12,2	13,2	13,9	14,6	15,1	15,6	16,0	16,4	16,4	16,4	16,4	16,4	16,4	16,4	16,4	16,4	16,4	16,4	16,4	16,4
150	11,8	12,6	13,2	13,7	14,2	14,6	14,9	15,3	15,6	15,9	16,2	16,4	16,4	16,4	16,4	16,4	16,4	16,4	16,4	16,4
200	11,6	12,2	12,7	13,2	13,6	13,9	14,3	14,6	14,8	15,1	15,4	15,6	15,8	16,0	16,2	16,4	16,4	16,4	16,4	16,4
250	11,4	12,0	12,4	12,8	13,2	13,5	13,8	14,1	14,3	14,6	14,8	15,0	15,2	15,4	15,6	15,8	15,9	16,1	16,3	16,4
300	11,3	11,8	12,2	12,6	12,9	13,2	13,5	13,7	13,9	14,2	14,4	14,6	14,8	14,9	15,1	15,3	15,4	15,6	15,7	15,9
350	11,3	11,7	12,0	12,4	12,7	12,9	13,2	13,4	13,6	13,8	14,0	14,2	14,4	14,6	14,7	14,9	15,0	15,2	15,3	15,5
400	11,2	11,6	11,9	12,2	12,5	12,7	13,0	13,2	13,4	13,6	13,8	13,9	14,1	14,3	14,4	14,6	14,7	14,8	15,0	15,1
450	11,2	11,5	11,8	12,1	12,3	12,6	12,8	13,0	13,2	13,4	13,5	13,7	13,9	14,0	14,2	14,3	14,4	14,6	14,7	14,8
500	11,1	11,4	11,7	12,0	12,2	12,4	12,6	12,8	13,0	13,2	13,4	13,5	13,7	13,8	13,9	14,1	14,2	14,3	14,5	14,6
550	11,1	11,4	11,6	11,9	12,1	12,3	12,5	12,7	12,9	13,0	13,2	13,3	13,5	13,6	13,8	13,9	14,0	14,1	14,2	14,4
600	11,1	11,3	11,6	11,8	12,0	12,2	12,4	12,6	12,7	12,9	13,0	13,2	13,3	13,5	13,6	13,7	13,8	13,9	14,1	14,2
650	11,1	11,3	11,5	11,7	11,9	12,1	12,3	12,5	12,6	12,8	12,9	13,1	13,2	13,3	13,4	13,6	13,7	13,8	13,9	14,0
700	11,0	11,3	11,5	11,7	11,9	12,0	12,2	12,4	12,5	12,7	12,8	12,9	13,1	13,2	13,3	13,4	13,5	13,6	13,7	13,8
750	11,0	11,2	11,4	11,6	11,8	12,0	12,1	12,3	12,4	12,6	12,7	12,8	13,0	13,1	13,2	13,3	13,4	13,5	13,6	13,7
800	11,0	11,2	11,4	11,6	11,8	11,9	12,1	12,2	12,4	12,5	12,6	12,7	12,9	13,0	13,1	13,2	13,3	13,4	13,5	13,6
850	11,0	11,2	11,4	11,5	11,7	11,9	12,0	12,1	12,3	12,4	12,5	12,7	12,8	12,9	13,0	13,1	13,2	13,3	13,4	13,5
900	11,0	11,2	11,3	11,5	11,7	11,8	12,0	12,1	12,2	12,3	12,5	12,6	12,7	12,8	12,9	13,0	13,1	13,2	13,3	13,4
950	11,0	11,2	11,3	11,5	11,6	11,8	11,9	12,0	12,2	12,3	12,4	12,5	12,6	12,7	12,8	12,9	13,0	13,1	13,2	13,3
1000	11,0	11,1	11,3	11,4	11,6	11,7	11,9	12,0	12,1	12,2	12,3	12,4	12,5	12,6	12,7	12,8	12,9	13,0	13,1	13,2

Matrix 5.1 Optimal Laden Speed – The Haugen model

The matrix shows how the optimal speed increases as the TC-rate increases and the bunker price decreases.

In the matrix we have circled out a combination of fuel price and TC-rate. The blue circle represents the optimal laden speed with today’s fuel price and TC-rate. The optimal speed is 12.5 knots and this is 6.1% lower than the AIS-reported speed of 13.31 knots (May 8, 2012). According to the Haugen model, the VLCC-fleet should reduce its speed with 6.1% on the laden leg.

**Ballast**

We have now shown how the optimal speed is dependent on the financing cost when the vessel is laden. If we now look at the VLCC in ballast we can disregard the financing cost in our calculations. We illustrate the optimal speed by generating a matrix like we did for the vessel laden:

Bunker price	OPTIMAL SPEED BALLAST																			
	TC rates [\$/day]																			
	2500	5000	7500	10000	12500	15000	17500	20000	22500	25000	27500	30000	32500	35000	37500	40000	42500	45000	47500	50000
100	10,4	12,1	13,3	14,1	14,8	15,4	15,9	16,4	16,8	16,9	16,9	16,9	16,9	16,9	16,9	16,9	16,9	16,9	16,9	16,9
150	9,5	11,1	12,1	12,9	13,6	14,1	14,6	15,0	15,4	15,7	16,1	16,4	16,6	16,9	16,9	16,9	16,9	16,9	16,9	16,9
200	8,9	10,4	11,4	12,1	12,7	13,3	13,7	14,1	14,5	14,8	15,1	15,4	15,6	15,9	16,1	16,4	16,6	16,8	16,9	16,9
250	8,5	9,9	10,8	11,5	12,1	12,6	13,1	13,5	13,8	14,1	14,4	14,7	14,9	15,2	15,4	15,6	15,8	16,0	16,2	16,4
300	8,2	9,5	10,4	11,1	11,6	12,1	12,6	12,9	13,3	13,6	13,9	14,1	14,4	14,6	14,8	15,0	15,2	15,4	15,6	15,7
350	8,0	9,2	10,0	10,7	11,2	11,7	12,1	12,5	12,8	13,1	13,4	13,7	13,9	14,1	14,3	14,5	14,7	14,9	15,1	15,2
400	7,8	8,9	9,7	10,4	10,9	11,4	11,8	12,1	12,5	12,7	13,0	13,3	13,5	13,7	13,9	14,1	14,3	14,5	14,6	14,8
450	7,7	8,7	9,5	10,1	10,6	11,1	11,5	11,8	12,1	12,4	12,7	12,9	13,2	13,4	13,6	13,8	13,9	14,1	14,3	14,4
500	7,6	8,5	9,3	9,9	10,4	10,8	11,2	11,5	11,8	12,1	12,4	12,6	12,9	13,1	13,3	13,5	13,6	13,8	14,0	14,1
550	7,4	8,4	9,1	9,7	10,1	10,6	11,0	11,3	11,6	11,9	12,1	12,4	12,6	12,8	13,0	13,2	13,4	13,5	13,7	13,8
600	7,2	8,2	8,9	9,5	10,0	10,4	10,7	11,1	11,4	11,6	11,9	12,1	12,3	12,6	12,7	12,9	13,1	13,3	13,4	13,6
650	7,0	8,1	8,8	9,3	9,8	10,2	10,5	10,9	11,2	11,4	11,7	11,9	12,1	12,3	12,5	12,7	12,9	13,0	13,2	13,3
700	6,9	8,0	8,6	9,2	9,6	10,0	10,4	10,7	11,0	11,2	11,5	11,7	11,9	12,1	12,3	12,5	12,7	12,8	13,0	13,1
750	6,8	7,9	8,5	9,0	9,5	9,9	10,2	10,5	10,8	11,1	11,3	11,5	11,7	11,9	12,1	12,3	12,5	12,6	12,8	12,9
800	6,7	7,8	8,4	8,9	9,3	9,7	10,1	10,4	10,7	10,9	11,1	11,4	11,6	11,8	12,0	12,1	12,3	12,5	12,6	12,7
850	6,6	7,8	8,3	8,8	9,2	9,6	9,9	10,2	10,5	10,8	11,0	11,2	11,4	11,6	11,8	12,0	12,1	12,3	12,4	12,6
900	6,5	7,7	8,2	8,7	9,1	9,5	9,8	10,1	10,4	10,6	10,9	11,1	11,3	11,5	11,6	11,8	12,0	12,1	12,3	12,4
950	6,4	7,7	8,1	8,6	9,0	9,4	9,7	10,0	10,2	10,5	10,7	10,9	11,1	11,3	11,5	11,7	11,8	12,0	12,1	12,3
1000	6,4	7,6	8,1	8,5	8,9	9,3	9,6	9,9	10,1	10,4	10,6	10,8	11,0	11,2	11,4	11,5	11,7	11,8	12,0	12,1

Matrix 5.2 Optimal Ballast Speed – The Haugen Model

The matrix also shows how the optimal speed increases as the TC-rate increases and the bunker price decreases. However, we can see that the optimal speed is lower. The lower optimal speed in general is due to no financing cost as there is no cargo when in ballast. Matrix 5.2 supports lower speed with no financing cost of cargo.

Like matrix 5.1, this matrix gives a general view of the optimal speed for any given route. The cost structure for the back-leg of the loop is not dependent of the financing cost; hence we can calculate the optimal speed in ballast given the other costs. The assumptions for this voyage are the same as for figure 5.2, and are listed in appendix F. In contrast to laden speed, the ballast speed is determined by the shipowner alone.

We have circled out the optimal combination of fuel price and TC-rate like in matrix 5.1. The blue circle represents the optimal ballast speed of 11 knots, which is 17.4% below the reported AIS-speed of 13.31 knots (May 8). The Haugen model matrix in ballast proposes that the fleet should further reduce its speed with as much as 17.4% (May 8, 2012).

### ***Criticism of the Haugen Model***

First of all, the Haugen model is based on assumptions. In real life many other factors will affect the optimal speed. These can be e.g. weather, speed negotiations between charterer and shipowner, waiting days in port and fluctuating cargo value during laden transport. These factors are not accounted for in the formula, and should be noticed. An increased speed may be optimal if it can provide the vessel with a new trip if arriving port earlier. Then the additional earnings must exceed the additional costs. This and other external influences are not accounted for in our calculations, but may affect the optimal speed.

Further is the AIS-reported speed the average speed for both ballast and laden, while the matrices are separated in ballast and laden. This is a source of error when comparing the results with actual speed. We can assume that actual speed in ballast will be lower than laden speed (Asheim, 2011). This means that the actual speed (corrected AIS speed) is higher laden and lower in ballast, since the AIS speed is an average. The optimal speed deviation in percentage will then be lower in ballast and even higher when the vessel is laden.



### 5.1.2 The Meyer Model

This model does not include financing cost of the cargo. As a consequence, the optimal speed will only be calculated as an average of a round trip. The Meyer formula was derived to calculate optimal speed for container vessels. However, we will adapt this formula to VLCCs with some adjustments.

The assumptions made to calculate the optimal speed are not the same as for the Haugen model. This is due to different inputs to calculate the optimal speed. All assumptions are listed in appendix E. With these assumptions made, we can use equation (28) to calculate optimal speed given TC-cost and bunker prices.

Bunker price	OPTIMAL SPEED TC rates [\$/day]																			
	2500	5000	7500	10000	12500	15000	17500	20000	22500	25000	27500	30000	32500	35000	37500	40000	42500	45000	47500	50000
100	6,9	9,2	10,5	11,4	12,1	12,7	13,2	13,7	14,1	14,4	14,8	15,1	15,4	15,7	15,9	16,2	16,4	16,4	16,4	16,4
150	6,6	8,6	9,7	10,5	11,2	11,7	12,2	12,6	13,0	13,3	13,6	13,9	14,1	14,4	14,6	14,8	15,1	15,3	15,4	15,6
200	6,4	8,2	9,2	10,0	10,6	11,1	11,5	11,9	12,2	12,5	12,8	13,1	13,3	13,6	13,8	14,0	14,2	14,4	14,5	14,7
250	6,2	7,9	8,8	9,5	10,1	10,6	11,0	11,3	11,7	12,0	12,2	12,5	12,7	12,9	13,1	13,3	13,5	13,7	13,9	14,0
300	6,1	7,6	8,5	9,2	9,7	10,2	10,6	10,9	11,2	11,5	11,8	12,0	12,2	12,4	12,6	12,8	13,0	13,2	13,4	13,5
350	5,3	7,4	8,3	8,9	9,4	9,9	10,2	10,6	10,9	11,1	11,4	11,6	11,8	12,1	12,2	12,4	12,6	12,8	12,9	13,1
400	5,0	7,3	8,1	8,7	9,2	9,6	10,0	10,3	10,6	10,8	11,1	11,3	11,5	11,7	11,9	12,1	12,3	12,4	12,6	12,7
450	4,9	7,1	7,9	8,5	9,0	9,4	9,7	10,0	10,3	10,6	10,8	11,0	11,2	11,4	11,6	11,8	12,0	12,1	12,3	12,4
500	4,9	7,0	7,8	8,3	8,8	9,2	9,5	9,8	10,1	10,4	10,6	10,8	11,0	11,2	11,4	11,5	11,7	11,8	12,0	12,1
550	4,9	6,4	7,6	8,2	8,6	9,0	9,3	9,6	9,9	10,2	10,4	10,6	10,8	11,0	11,1	11,3	11,5	11,6	11,7	11,9
600	4,9	6,2	7,4	8,1	8,5	8,9	9,2	9,5	9,7	10,0	10,2	10,4	10,6	10,8	10,9	11,1	11,2	11,4	11,5	11,7
650	4,9	6,0	7,2	7,9	8,4	8,7	9,0	9,3	9,6	9,8	10,0	10,2	10,4	10,6	10,8	10,9	11,1	11,2	11,3	11,5
700	4,9	5,9	7,0	7,8	8,3	8,6	8,9	9,2	9,4	9,7	9,9	10,1	10,3	10,4	10,6	10,7	10,9	11,0	11,2	11,3
750	4,9	5,7	6,8	7,6	8,1	8,5	8,8	9,1	9,3	9,5	9,7	9,9	10,1	10,3	10,4	10,6	10,7	10,9	11,0	11,1
800	4,9	5,6	6,7	7,5	8,1	8,4	8,7	8,9	9,2	9,4	9,6	9,8	10,0	10,1	10,3	10,4	10,6	10,7	10,9	11,0
850	4,9	5,4	6,5	7,3	8,0	8,3	8,6	8,8	9,1	9,3	9,5	9,7	9,8	10,0	10,2	10,3	10,5	10,6	10,7	10,8
900	4,9	5,3	6,4	7,2	7,8	8,2	8,5	8,7	9,0	9,2	9,4	9,6	9,7	9,9	10,0	10,2	10,3	10,5	10,6	10,7
950	4,9	5,2	6,3	7,0	7,7	8,1	8,4	8,6	8,9	9,1	9,3	9,5	9,6	9,8	9,9	10,1	10,2	10,3	10,5	10,6
1000	4,9	5,1	6,1	6,9	7,5	8,1	8,3	8,6	8,8	9,0	9,2	9,4	9,5	9,7	9,8	10,0	10,1	10,2	10,4	10,5

Matrix 5.3 Optimal Speed – The Meyer Model

Like matrix 5.1 and 5.2, the optimal speed increases as the TC-rate increases and the bunker price decreases. However, the optimal speed is not equal in the two equations. A comparison of the two models and our findings will be elaborated later in our dissertation.

In the matrix we have circled out a combination of fuel price and TC-rate. The blue circle represents the optimal speed with today’s fuel price and TC-rate (May 8, 2012). The optimal speed is 9.4 knots according to the Meyer model, and 29% below the AIS-speed of 13.31 knots (May 8, 2012). The Meyer model matrix proposes that the fleet should further reduce its speed with 29% (May 8, 2012).

### ***Criticism of the Meyer Model***

The Meyer model is a less complex model than the Haugen model, and is not originally made to calculate optimal speed for VLCCs. The model is adjusted to the tanker market, which affects the results and gives ground for criticism. Like the Haugen model, many other factors will affect the optimal speed. These factors are neither accounted for in this formula. The greatest source of error is probably that there is no division between the laden and ballast leg of the loop. This includes no financing cost of the cargo, which is unrealistic given the cargo value.

It should also be mentioned that our model is limited at 10 % and 90 % engine load like the Haugen model (see assumption appendix D). This implies that the minimum speed is 4.9 knots. As we see from the matrix above, the optimal speed is 4.9 knots when the freight rates are low and bunker prices high. If we had not set the engine load limits, the optimal speed would be even lower than 4.9 knots. However, a speed of 4.9 knots will not be optimal. This is because of other problems that may arise at such a low speed. Examples may be reduced manoeuvring control of the vessel and that longer loops will affect the working conditions for the crew (Hunter, 2011).

Both the results in the Meyer model and the AIS reported speed is an average of ballast and laden. This makes the Meyer model a better basis for comparison with the AIS speed. Still, the Meyer model deviates more than the Haugen model from the AIS speed. The results from the Meyer model are therefore less reliable. It is difficult to say why the optimal speed is much lower in the Meyer model, this can either be caused by the model itself or because we have adjusted the model to the tanker market.

### **5.1.3 Average Optimal Speed**

We have presented optimal speed both for the Haugen and the Meyer model. We have already seen that the models estimate optimal speed different, and therefore the results are diverging. In the calculations of the average optimal speed, we have used the laden speed from the Haugen model in the average laden speed. The optimal ballast speed in the Haugen model is used to calculate the optimal average ballast speed. The Meyer model does not separate between laden and ballast. Therefore we have used the general optimal speed for the Meyer model. Beneath we have calculated the average optimal speed both laden and ballast.

Bunker price	AVERAGE OPTIMAL SPEED LADEN																			
	TC rates [\$/day]																			
	2500	5000	7500	10000	12500	15000	17500	20000	22500	25000	27500	30000	32500	35000	37500	40000	42500	45000	47500	50000
100	9,6	11,2	12,2	13,0	13,6	14,1	14,6	15,0	15,2	15,4	15,6	15,8	15,9	16,0	16,2	16,3	16,4	16,4	16,4	16,4
150	9,2	10,6	11,5	12,1	12,7	13,1	13,6	13,9	14,3	14,6	14,9	15,1	15,3	15,4	15,5	15,6	15,7	15,8	15,9	16,0
200	9,0	10,2	11,0	11,6	12,1	12,5	12,9	13,2	13,5	13,8	14,1	14,3	14,6	14,8	15,0	15,2	15,3	15,4	15,5	15,6
250	8,8	9,9	10,6	11,2	11,6	12,0	12,4	12,7	13,0	13,3	13,5	13,7	14,0	14,2	14,4	14,5	14,7	14,9	15,1	15,2
300	8,7	9,7	10,4	10,9	11,3	11,7	12,0	12,3	12,6	12,8	13,1	13,3	13,5	13,7	13,9	14,1	14,2	14,4	14,5	14,7
350	8,3	9,6	10,2	10,6	11,1	11,4	11,7	12,0	12,3	12,5	12,7	12,9	13,1	13,3	13,5	13,7	13,8	14,0	14,1	14,3
400	8,1	9,4	10,0	10,5	10,8	11,2	11,5	11,7	12,0	12,2	12,4	12,6	12,8	13,0	13,2	13,3	13,5	13,6	13,8	13,9
450	8,0	9,3	9,9	10,3	10,7	11,0	11,3	11,5	11,8	12,0	12,2	12,4	12,6	12,7	12,9	13,0	13,2	13,3	13,5	13,6
500	8,0	9,2	9,7	10,2	10,5	10,8	11,1	11,3	11,6	11,8	12,0	12,2	12,3	12,5	12,7	12,8	12,9	13,1	13,2	13,3
550	8,0	8,9	9,6	10,0	10,4	10,7	10,9	11,2	11,4	11,6	11,8	12,0	12,1	12,3	12,4	12,6	12,7	12,9	13,0	13,1
600	8,0	8,8	9,5	9,9	10,3	10,5	10,8	11,0	11,2	11,4	11,6	11,8	12,0	12,1	12,3	12,4	12,5	12,7	12,8	12,9
650	8,0	8,7	9,4	9,8	10,2	10,4	10,7	10,9	11,1	11,3	11,5	11,6	11,8	12,0	12,1	12,2	12,4	12,5	12,6	12,7
700	8,0	8,6	9,2	9,8	10,1	10,3	10,6	10,8	11,0	11,2	11,3	11,5	11,7	11,8	11,9	12,1	12,2	12,3	12,5	12,6
750	8,0	8,5	9,1	9,6	10,0	10,2	10,5	10,7	10,9	11,0	11,2	11,4	11,5	11,7	11,8	11,9	12,1	12,2	12,3	12,4
800	8,0	8,4	9,0	9,5	9,9	10,2	10,4	10,6	10,8	10,9	11,1	11,3	11,4	11,6	11,7	11,8	11,9	12,1	12,2	12,3
850	8,0	8,3	9,0	9,4	9,8	10,1	10,3	10,5	10,7	10,8	11,0	11,2	11,3	11,4	11,6	11,7	11,8	11,9	12,1	12,2
900	7,9	8,2	8,9	9,3	9,7	10,0	10,2	10,4	10,6	10,8	10,9	11,1	11,2	11,3	11,5	11,6	11,7	11,8	11,9	12,0
950	7,9	8,2	8,8	9,3	9,6	9,9	10,1	10,3	10,5	10,7	10,8	11,0	11,1	11,2	11,4	11,5	11,6	11,7	11,8	11,9
1000	7,9	8,1	8,7	9,2	9,6	9,9	10,1	10,3	10,4	10,6	10,8	10,9	11,0	11,2	11,3	11,4	11,5	11,6	11,7	11,8

Matrix 5.4 Average Optimal Speed Laden – The Haugen and Meyer Model

Given this scale, we can see that the average optimal speed increases with higher freight rates and lower bunker prices. The optimal speed is decreasing as the bunker price increases, but in a small extent compared to the impact from freight rate changes.

The blue circle represents the optimal average laden speed with today’s fuel price and TC-rate. This is 11 knots laden, which is 17.4% below the speed the fleet is steaming at (13.31 knots, May 8).

Beneath we have made a new matrix with average optimal speed in ballast. We have used the ballast speed for the Haugen model and the general optimal speed for the Meyer model.

Bunker price	AVERAGE OPTIMAL SPEED BALLAST																			
	TC rates [\$/day]																			
	2500	5000	7500	10000	12500	15000	17500	20000	22500	25000	27500	30000	32500	35000	37500	40000	42500	45000	47500	50000
100	8,6	10,7	11,9	12,8	13,5	14,0	14,6	15,0	15,4	15,7	15,9	16,0	16,2	16,3	16,4	16,4	16,4	16,4	16,4	16,4
150	8,0	9,8	10,9	11,7	12,4	12,9	13,4	13,8	14,2	14,5	14,8	15,1	15,4	15,7	15,8	15,9	16,0	16,1	16,2	16,3
200	7,6	9,3	10,3	11,0	11,6	12,2	12,6	13,0	13,3	13,7	14,0	14,2	14,5	14,7	15,0	15,2	15,4	15,6	15,7	15,8
250	7,4	8,9	9,8	10,5	11,1	11,6	12,0	12,4	12,7	13,0	13,3	13,6	13,8	14,0	14,3	14,5	14,7	14,8	15,0	15,2
300	7,2	8,5	9,4	10,1	10,7	11,2	11,6	11,9	12,2	12,5	12,8	13,1	13,3	13,5	13,7	13,9	14,1	14,3	14,5	14,6
350	6,7	8,3	9,2	9,8	10,3	10,8	11,2	11,5	11,8	12,1	12,4	12,6	12,9	13,1	13,3	13,5	13,7	13,8	14,0	14,2
400	6,4	8,1	8,9	9,5	10,0	10,5	10,9	11,2	11,5	11,8	12,1	12,3	12,5	12,7	12,9	13,1	13,3	13,4	13,6	13,8
450	6,3	7,9	8,7	9,3	9,8	10,2	10,6	10,9	11,2	11,5	11,8	12,0	12,2	12,4	12,6	12,8	12,9	13,1	13,3	13,4
500	6,3	7,8	8,5	9,1	9,6	10,0	10,4	10,7	11,0	11,2	11,5	11,7	11,9	12,1	12,3	12,5	12,7	12,8	13,0	13,1
550	6,1	7,4	8,4	8,9	9,4	9,8	10,2	10,5	10,8	11,0	11,3	11,5	11,7	11,9	12,1	12,2	12,4	12,6	12,7	12,9
600	6,1	7,2	8,1	8,8	9,2	9,6	10,0	10,3	10,6	10,8	11,0	11,3	11,5	11,7	11,8	12,0	12,2	12,3	12,5	12,6
650	6,0	7,1	8,0	8,6	9,1	9,5	9,8	10,1	10,4	10,6	10,9	11,1	11,3	11,5	11,6	11,8	12,0	12,1	12,3	12,4
700	5,9	6,9	7,8	8,5	8,9	9,3	9,6	9,9	10,2	10,5	10,7	10,9	11,1	11,3	11,5	11,6	11,8	11,9	12,1	12,2
750	5,8	6,8	7,7	8,3	8,8	9,2	9,5	9,8	10,1	10,3	10,5	10,7	10,9	11,1	11,3	11,4	11,6	11,8	11,9	12,0
800	5,8	6,7	7,5	8,2	8,7	9,1	9,4	9,7	9,9	10,2	10,4	10,6	10,8	11,0	11,1	11,3	11,4	11,6	11,7	11,9
850	5,7	6,6	7,4	8,1	8,6	8,9	9,3	9,5	9,8	10,0	10,2	10,4	10,6	10,8	11,0	11,1	11,3	11,4	11,6	11,7
900	5,7	6,5	7,3	7,9	8,5	8,8	9,1	9,4	9,7	9,9	10,1	10,3	10,5	10,7	10,8	11,0	11,2	11,3	11,4	11,6
950	5,7	6,4	7,2	7,8	8,3	8,7	9,0	9,3	9,6	9,8	10,0	10,2	10,4	10,6	10,7	10,9	11,0	11,2	11,3	11,4
1000	5,6	6,3	7,1	7,7	8,2	8,7	8,9	9,2	9,5	9,7	9,9	10,1	10,3	10,4	10,6	10,8	10,9	11,0	11,2	11,3

Matrix 5.5 Average Optimal Speed Ballast – The Haugen and Meyer Model

From matrix 5.5, we can see that the optimal speed in ballast is reduced by 0.8 knots compared to the laden speed. The average optimal ballast speed is 10.2 knots, and 23.4% below the speed that the fleet is currently steaming at (13.31 knots, May 8).

Given matrix 5.4 and 5.5, we have made a new matrix which shows when it is optimal to slow steam. This is only to emphasize that speed reduction has a potential profit. To simplify we will compare two situations; slow steaming and full speed. Hence the savings presented will be compared to full speed (16.4 knots laden), and any speed reduction from full speed will be described as slow steaming. In this matrix slow steaming is whenever there is a speed reduction from full speed (16.4 knots) that generates savings.

Bunker price	When to slow steam																			
	TC rates [\$/day]																			
	2500	5000	7500	10000	12500	15000	17500	20000	22500	25000	27500	30000	32500	35000	37500	40000	42500	45000	47500	50000
100	1	1	1	1	1	1	1	1	0	0	0	0	0	0	0	0	0	0	0	0
150	1	1	1	1	1	1	1	1	1	1	1	1	0	0	0	0	0	0	0	0
200	1	1	1	1	1	1	1	1	1	1	1	1	1	1	1	0	0	0	0	0
250	1	1	1	1	1	1	1	1	1	1	1	1	1	1	1	1	1	1	1	0
300	1	1	1	1	1	1	1	1	1	1	1	1	1	1	1	1	1	1	1	1
350	1	1	1	1	1	1	1	1	1	1	1	1	1	1	1	1	1	1	1	1
400	1	1	1	1	1	1	1	1	1	1	1	1	1	1	1	1	1	1	1	1
450	1	1	1	1	1	1	1	1	1	1	1	1	1	1	1	1	1	1	1	1
500	1	1	1	1	1	1	1	1	1	1	1	1	1	1	1	1	1	1	1	1
550	1	1	1	1	1	1	1	1	1	1	1	1	1	1	1	1	1	1	1	1
600	1	1	1	1	1	1	1	1	1	1	1	1	1	1	1	1	1	1	1	1
650	1	1	1	1	1	1	1	1	1	1	1	1	1	1	1	1	1	1	1	1
700	1	1	1	1	1	1	1	1	1	1	1	1	1	1	1	1	1	1	1	1
750	1	1	1	1	1	1	1	1	1	1	1	1	1	1	1	1	1	1	1	1
800	1	1	1	1	1	1	1	1	1	1	1	1	1	1	1	1	1	1	1	1
850	1	1	1	1	1	1	1	1	1	1	1	1	1	1	1	1	1	1	1	1
900	1	1	1	1	1	1	1	1	1	1	1	1	1	1	1	1	1	1	1	1
950	1	1	1	1	1	1	1	1	1	1	1	1	1	1	1	1	1	1	1	1
1000	1	1	1	1	1	1	1	1	1	1	1	1	1	1	1	1	1	1	1	1

Matrix 5.6 When to Slow Steam – The Haugen and Meyer Model

The number 1 indicates that slow steaming is profitable, while 0 indicates the opposite. Note that any reduction from 16.4 knots will indicate that slow steaming is profitable. This is to illustrate how frequently it exist a savings potential from speed reduction. Matrix 5.4 and 5.5, in addition to the savings matrices in appendix G, show this more detailed.

We have now found an optimal speed from the Haugen and the Meyer model, and as well calculated an average of the two models. In the next section we will compare the historical optimal speed with the actual speed.

### 5.1.4 Historical Optimal Speed

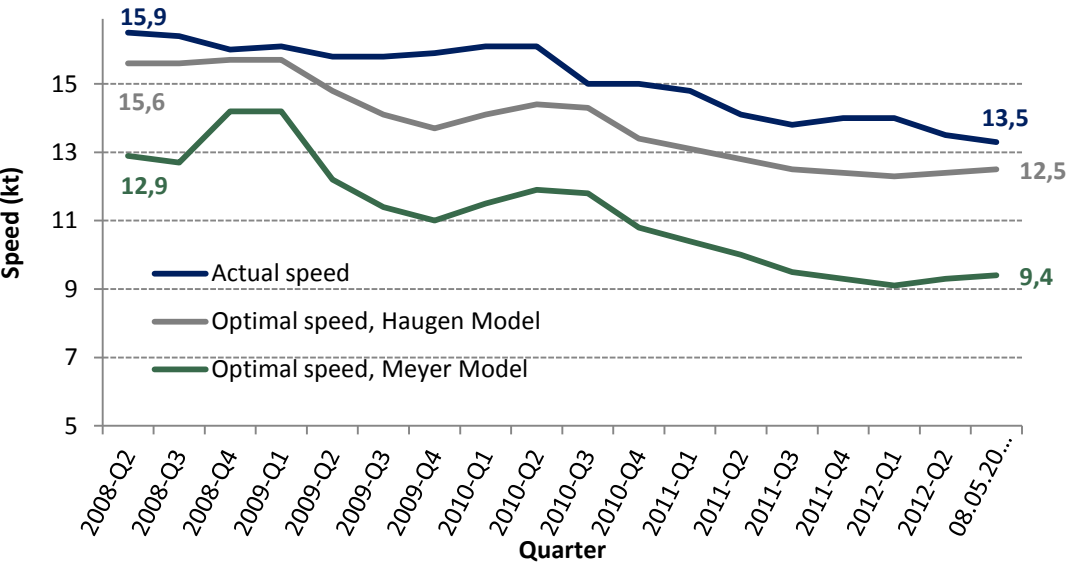

Figure 5.2 Historical Optimal Speed VLCCs (Bloomberg, Haugen Model, Meyer Model)

In figure 5.2 we illustrate the historical optimal speed from both the Haugen model and the Meyer model. These are compared to the actual historical speed for VLCCs, also shown in figure 4.11. We observe that our calculated optimal speed for both models is below the actual steaming speed. This confirms our findings in chapter 5.1 and 5.2. Slow steaming has been, and still is, optimal for VLCCs, given the TC-rates and bunker prices. From our calculations, we see that the VLCC-fleet still has a savings potential by reducing speed further.

We have now used two models to assess the optimal VLCC speed. By comparing the results from both models, we have to some extent quality checked the models. However, we have not presented any verification that acknowledges the optimal speeds found. We will in the next two sections compare our results with optimal speed on TD3.

### 5.2 Quality Assessment of the Models

We will in this section evaluate the quality of our calculated optimal speed. First we will compare our results with a calculated cost-minimizing speed, before we will compare with Frontline’s (the world’s largest private owned tanker company) optimal speed calculations.

### 5.2.1 Cost-Minimizing (Optimal) Speed at TD3

The matrices presented for both formulas give a general view of the optimal speed for any given route. To quality assess our calculations of optimal speed, we will compare our results with a cost-minimizing model. This will give an indication of how reliable our results are.

If we look at a specific voyage, we can calculate the optimal speed given the costs. The assumptions for this voyage are based on TD3, and are listed in appendix F. To be able to place all figures in USD/tonne, we have divided all costs by the intake, 265,000 tonnes (2 million barrels).

In the figures below we will present simple voyage calculations to illustrate the optimal speed given the freight costs both when vessel is laden and in ballast. The optimal speed is where the total transportation cost is minimized.

**Laden**

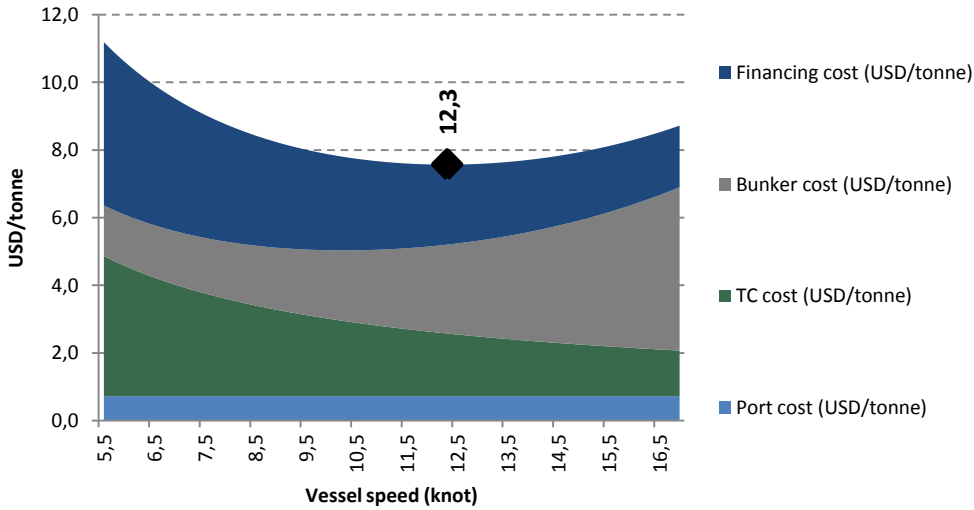

**Figure 5.3** Cost-Minimizing (Optimal) Speed Laden at TD3 (Haugen, Clarksons, Baltic Exchange, Own Assumptions)

From the figure we can see that the optimal speed laden is 12.3 knots. When the speed increases, both TC-cost and financing cost decrease. This supports slow steaming as a cost saving solution. Port costs are not affected, since they do not depend on the chosen vessel speed.

The optimal speed in the Haugen and the Meyer model are respectively 12.5 knots (laden) and 9.4 knots (laden/ballast), while the optimal speed in this voyage calculation is 12.3 knots. The deviations from the cost-minimizing speed in the models are 1.6% (Haugen) and 30.9% (Meyer). The Meyer model’s optimal speed deviates significantly more than the Haugen model. The reason to this large deviation could be the financial cost that is accounted for in the voyage calculation, but not in the Meyer model. If this is the reason to the large deviation, we should expect that the optimal *ballast* speed in this voyage calculation is closer to the optimal speed in the Meyer model.

**Ballast**

In the chart below we have presented the optimal speed for TD3 when the vessel is in ballast. The optimal speed is still where the total transportation cost is minimized. Port and financing cost is not included in ballast.

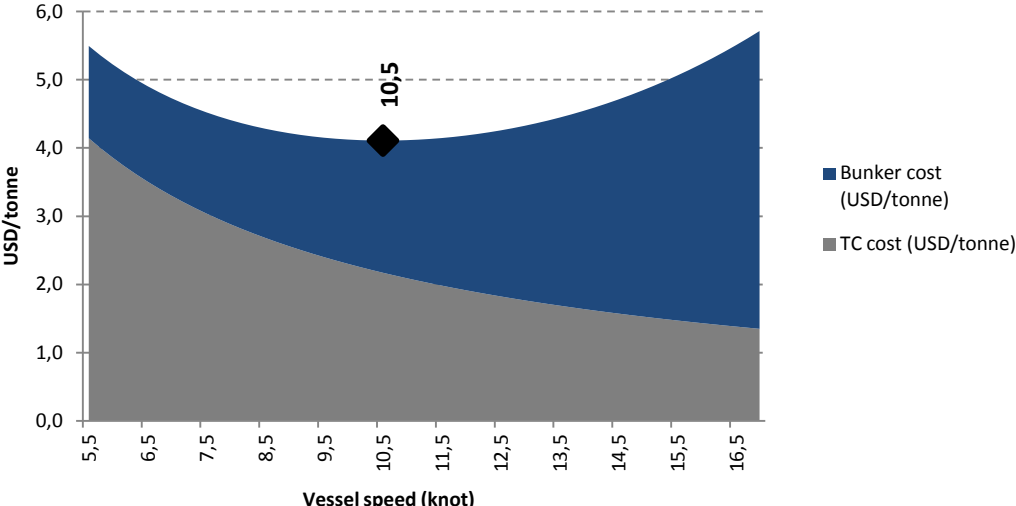

**Figure 5.4** Cost Minimizing (Optimal) Speed in Ballast at TD3 (Haugen, Clarksons, Baltic Exchange, Own Assumptions)

As a consequence of no financing and port cost in ballast, the optimal speed decreases. This reduces the optimal speed from 12.3 to 10.5 knots.

The optimal speed in the Haugen and the Meyer model are respectively 11 knots and 9.4 knots, while the cost-minimizing speed in ballast is 10.5 knots. The deviation in the Haugen model is 4.5%, while it is 11.7% in the Meyer model. The deviation from the Meyer model is

less in ballast compared to laden. Still, the results from the Haugen model is closer to the cost minimizing (optimal) speed.

Based on our results from the TD3 calculation, the optimal speed matrix for the Haugen model gives us credible results. The Haugen model corresponds best, both laden and ballast, compared to the cost minimizing speed at TD3. The Meyer model is far from the cost-minimizing speed, especially laden. This makes the Meyer model less reliable.

**5.2.2 Frontline’s Optimal Speed at TD3**

In this section we will quality assess our results with an optimal speed provided by Frontline’s Operational Manager, Per Gunnar Asheim.

Frontline’s calculations are confidential, thus we can only present their optimal speed results. The calculations are made for TD3 with input data from Frontline’s vessels on this route.<sup>12</sup> The optimal speed is based on Frontline spot data from April 25<sup>th</sup> 2012. These data are therefore almost exactly the same as our data used in both models from May 8, 2012. This makes the Frontline model reliable when comparing the results. Beneath we have extracted the results from their model.

Laden Miles	6 655	Ballast Miles	6 650
5% Weather factor	6 988	5% Weather factor	6 983
Speed laden	12,50	Speed ballast	11,00
Laden Days	<b>23,29</b>	Ballast days	<b>26,45</b>

**Table 5.1** *Frontline’s Optimal Speed Laden and Ballast at TD3 (Asheim, 2012)*

From the figure above, we can see that Frontline estimate the optimal laden speed to be 12.5 knots, while the optimal ballast speed is 11.0 knots.

In our cost minimizing calculations of route TD3, we found that the optimal speed was 12.3 knots laden and 10.5 knots in ballast (section 5.2.3). The cost minimizing calculation of TD3 deviates approximately 1.6% laden and 4.8% in ballast from Frontline’s optimal speed. Both Frontline and the TD3 calculation are a bare cost-minimizing calculation, and do not take any speed bargaining between shipowner and charterer into account. Since both calculations (TD3

<sup>12</sup> For explanation of TD3, see section 1.4.



cost-minimizing and Frontline TD3) are not affected by this kind of externalities, they are a good basis for quality checking our results. With this as a basis, we will now compare Frontline's optimal speed with the optimal speed in the Haugen and the Meyer model.

First of all, we can see that Frontline's calculated laden speed is almost 14% higher than the ballast speed. A higher laden speed is in accordance with findings in the Haugen model, that separates optimal laden and ballast speed. In chapter 5.1.1 we found the optimal speed with the Haugen model to be 12.5 knots laden, and 11.0 knots in ballast. We observe that the optimal speed found with the Haugen model is precisely the same as Frontline's optimal speed. This strengthens the validity of the Haugen model.

In the Meyer model, we found an optimal speed of 9.4 knots (section 5.1.2). This is an average of the laden and ballast speed. Frontline's average laden and ballast speed is 11.75 knots, and the optimal speed in the Meyer model deviates 25% from this. The results from the Meyer model are therefore not as significant as the Haugen model, even though the Meyer model shows tendencies that vessels should steam slower.

### **5.3 Savings from Optimal Speed**

In this and next section we will focus on the savings from choosing optimal speed for VLCCs. To simplify we will compare two situations; slow steaming and full speed. Hence the savings presented will be compared to full speed (16.4 knots laden), and any speed reduction from full speed will be described as slow steaming. We want to compare with full speed to get a wider range of the savings potential from speed reduction.

#### **5.3.1 Savings per Day**

The main reason to slow steam is to reduce costs. We have used the optimal speed found in the Haugen and Meyer model to calculate the savings from slow steaming. The savings can be presented both on a USD/day and USD/mile basis. Savings matrices both for the Haugen and Meyer model are presented in appendix G. From these matrices we can clearly see that the savings from slow steaming are significant. Given our assumptions from May 8, the savings are as follows:

<i>The Haugen Model</i>	<b>Savings (USD/day)</b>	<b>Speed (kt)</b>
Laden	11 000	12.5
Ballast	16 000	11.0
<i>The Meyer Model</i>		
Laden/Ballast	60 000	9.4

**Table 5.2 Savings per Day – The Haugen and Meyer Model**

From the table we see that the savings from the Meyer model are almost four times the savings from the Haugen model in ballast and even more laden. This seems unrealistic, and in general the Meyer model returns much higher potential savings than the Haugen model (see appendix G). The omission of financing cost constitutes only a small proportion of the large gap in potential savings. The main explanation to the high savings result is that the Meyer model in general returns unrealistic low optimal speeds. When these optimal speeds are compared to full speed, the savings will be disproportionate.

In the matrix below we show the average savings from both the Haugen (laden) and Meyer model.

Bunker price	Average savings per day compared to full speed																			
	TC rates [\$/day]																			
	2500	5000	7500	10000	12500	15000	17500	20000	22500	25000	27500	30000	32500	35000	37500	40000	42500	45000	47500	50000
150	4 425	4 467	4 006	3 483	2 981	2 526	2 125	1 780	1 479	1 205	959	740	546	377	232	111	12	0	0	0
200	6 899	7 237	6 863	6 331	5 765	5 207	4 676	4 180	3 722	3 303	2 924	2 585	2 276	1 986	1 716	1 465	1 232	1 017	820	640
250	9 308	9 948	9 704	9 222	8 657	8 069	7 484	6 916	6 371	5 853	5 365	4 908	4 481	4 084	3 718	3 382	3 069	2 772	2 489	2 221
300	11 680	12 605	12 505	12 098	11 567	10 985	10 384	9 783	9 193	8 619	8 066	7 536	7 029	6 547	6 090	5 658	5 251	4 869	4 511	4 176
350	14 040	15 217	15 265	14 946	14 465	13 907	13 312	12 703	12 092	11 488	10 896	10 320	9 761	9 222	8 703	8 205	7 727	7 271	6 836	6 422
400	14 948	17 795	17 986	17 761	17 340	16 819	16 244	15 640	15 024	14 406	13 793	13 189	12 597	12 019	11 457	10 911	10 383	9 873	9 381	8 907
450	16 494	20 346	20 675	20 544	20 190	19 713	19 166	18 578	17 968	17 348	16 725	16 105	15 492	14 888	14 296	13 717	13 152	12 602	12 067	11 548
500	18 330	22 880	23 335	23 298	23 012	22 585	22 072	21 508	20 911	20 296	19 672	19 045	18 421	17 801	17 189	16 586	15 994	15 414	14 847	14 293
550	20 495	25 404	25 971	26 027	25 810	25 435	24 961	24 424	23 846	23 243	22 624	21 998	21 368	20 739	20 114	19 496	18 885	18 283	17 692	17 112
600	22 660	26 527	28 588	28 731	28 584	28 263	27 830	27 325	26 770	26 183	25 575	24 953	24 323	23 691	23 060	22 431	21 807	21 190	20 581	19 980
650	24 826	28 474	30 832	31 415	31 336	31 070	30 681	30 209	29 681	29 113	28 518	27 906	27 281	26 650	26 016	25 382	24 750	24 122	23 500	22 884
700	26 991	30 358	33 073	34 081	34 069	33 857	33 512	33 076	32 576	32 031	31 453	30 852	30 236	29 609	28 977	28 341	27 705	27 070	26 439	25 813
750	29 156	32 183	35 257	36 732	36 783	36 626	36 326	35 927	35 457	34 936	34 377	33 791	33 186	32 566	31 938	31 304	30 666	30 029	29 392	28 759
800	31 322	33 954	37 387	39 069	39 482	39 377	39 123	38 761	38 323	37 827	37 290	36 720	36 128	35 518	34 896	34 266	33 631	32 992	32 353	31 715
850	33 487	35 672	39 468	41 390	42 166	42 113	41 903	41 580	41 174	40 705	40 190	39 639	39 061	38 463	37 850	37 226	36 595	35 958	35 319	34 679
900	35 652	37 341	41 503	43 664	44 837	44 834	44 668	44 384	44 010	43 569	43 078	42 546	41 985	41 400	40 798	40 182	39 556	38 923	38 286	37 645
950	37 817	38 963	43 493	45 895	47 236	47 542	47 420	47 173	46 833	46 420	45 953	45 443	44 899	44 329	43 738	43 131	42 513	41 885	41 251	40 613
1000	39 983	40 539	45 441	48 084	49 607	50 238	50 158	49 949	49 642	49 259	48 816	48 328	47 802	47 248	46 670	46 074	45 465	44 844	44 215	43 580

**Matrix 5.7 Average Savings in USD per Day Compared to Full Speed – The Haugen and Meyer Model**

The matrix is formatted to show a fading scale from dark green to dark red, where dark green symbolizes the highest savings and red the lowest. Yellow is in between green and red. Given this scale, we can see that the average savings increase with higher bunker prices. The savings are decreasing as the freight rate increases, but in small extent compared to the impact from bunker price changes. Our analysis concentrates on the economics of slow steaming within tanker shipping segment, but the models can easily be adapted to other segments of the shipping industry (Blackley, 1981).

The situation today (blue circle) indicates that a VLCC can save in excess of 32,000 USD/day if it reduces its speed from 16.4 to 11 knots. As an example, the potential savings from a 50 days route constitutes USD 1,628,800 in total. Notice that this is an example based on the average savings from both models, and that the Meyer model boosts the savings potential (cf. Table 5.2).

In these calculations, the savings are presented in USD/day, and are therefore not comparable with an increased Time Charter Equivalent (TCE).<sup>13</sup> This is because only the days at sea are accounted for, and not fixed costs (that are independent from speed). Shipowners often use TCE to compare earnings on different routes. We will therefore look at the potential savings in TCE from slow steaming.

---

<sup>13</sup> For explanation of TCE, see section 1.4.

### 5.3.2 Increase in TCE with Optimal Speed

In addition to the fixed costs, the TCE-calculation does not take the financing cost into account. The freight is often agreed as a USD/tonne figure, and based on this we have calculated the TCE for TD3. We have used the specifications for this route presented by the Baltic Exchange. These specifications and our assumptions are presented in appendix H.

We have presented our results in the figures below.

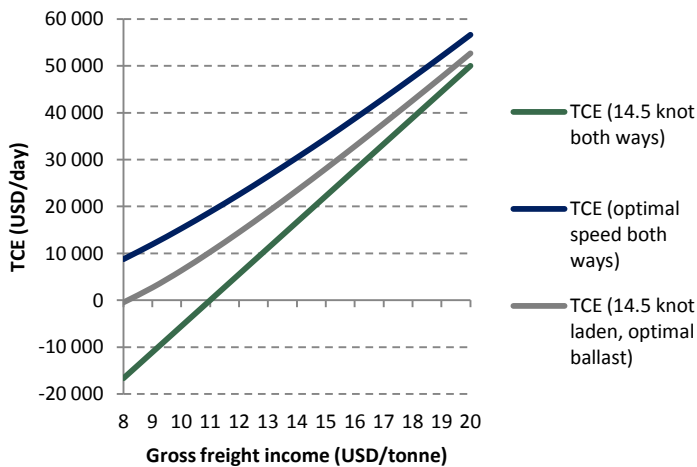

**Figure 5.5** TCE calculations - Speed/Consumption Combinations (Haugen, Baltic Exchange, Own Assumptions)

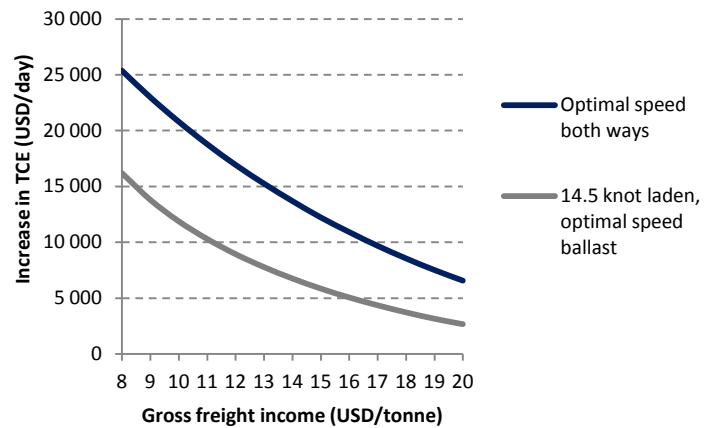

**Figure 5.6** Additional Profits from Speed Optimization (Haugen, Baltic Exchange, Own Assumptions)

From figure 5.5 we see that the TCE is negative when the gross freight rate is below 11 USD/tonne and the vessel steams at 14.5 both ways. If we instead use the optimal speed from the Haugen model, the TCE is almost 20,000 USD/day when the gross freight income is 11 USD/tonne. Our results show that slow steaming is optimal, which is reflected in an increased TCE. We know that the TCE is affected by the relationship between supply, demand and bunker prices in the market. Given the current market conditions (May 8), slow steaming is supported as an optimal strategy.

We can see from figure 5.6 that the profit from optimal speed increases as the freight rate decreases. The effect is the same when the laden leg has a speed of 14.5 knots, but it gives a smaller increase in TCE.

If the model is restricted use optimal speed only at the ballast leg, the TCE at 11 USD/tonne is approximately 10,000 USD/day. The TCE difference is reduced as the freight rate increases. Hence the additional profit from speed optimization decreases as the lines converge.

In this chapter we have used our two models to calculate the optimal speed. We have also shown the potential savings for VLCCs from slow steaming. Our findings recommend that the VLCC fleet's optimal speed under current market conditions is reached through lower speed, hence slow steaming is optimal. In the following chapter we will look into different effects of slow steaming.

## **6. Effects of Slow Steaming**

In this chapter we will elaborate other potential impacts of slow steaming than cost savings. To begin with, we will look at the environmental effects, before we look at issues that may arise due to slow steaming. These issues are market, legal, technical and organizational. Finally we will look at how piracy can have a negative impact on slow steaming.

### **6.1 Environmental Issues**

In addition to the economic aspect, there may be environmental savings from slow steaming. Naturally, reduced consumption of fossil fuel will reduce emissions. Environmental impacts of speed reduction have been highly discussed, and an increased global focus on emission reduction makes this topic very relevant. It is a very extensive subject, so wide that we could have written a separate thesis about it. Since we have chosen to focus our thesis around the economic aspect of slow steaming, we will just briefly touch upon some of the environmental issues.

#### **6.1.1 CO<sub>2</sub> Emissions**

CO<sub>2</sub> is regarded as an important contributor to the greenhouse effect, and is a direct product of combustion. In 2011 international shipping is estimated to have contributed to about 3.3% of the global emissions of CO<sub>2</sub> (Klanac, 2011). Shipping transports 90% of world trade and many goods could not have been transported any other way than by ships. By year 2050, in the absence of policies and reduction methods, CO<sub>2</sub> emissions could grow to 10% - 32% as a result of the growth in world trade (IMO, 2009).

CO<sub>2</sub> emission can be reduced by introducing new technological methods, like hull shapes, anti-fouling systems etc (Alvik et al, 2010). These systems can be a costly investment for shipping companies. In addition, few technological solutions are fully developed. However, substantial savings can be achieved by reducing speed (Alvarez et al, 2010). This is even more relevant for certain vessel types, e.g. container shipping because these normally operate at the highest speeds. For VLCCs, slow steaming as a way to reduce emissions is certainly relevant (Holmvang, 2008).

Even if green house gases (GHG) are the most known emission, slow steaming will reduce all shipping air emissions. Emissions of Sulfur oxide (SO<sub>x</sub>) and Nitrogen oxide (NO<sub>x</sub>) will decrease in line with the fuel consumption and the CO<sub>2</sub> reduction (Cariou, 2011).

**6.1.2 Increased Focus on Emission Reduction**

Many companies have increased their attention to this subject; one is the giant shipping company Maersk. Eivind Kolding, Maersk Line CEO, has stated:

*“For Maersk Line slow steaming is here to stay because it remains a win-win-win situation. It is better for our customers, better for the environment, and better for our business”* (Maersk, 2010).<sup>14</sup>

Maersk is one of the biggest players in the shipping market, and their opinions and concerns have an impact on the rest of the business. They have a broad focus on sustainability in their strategy, probably encouraging others to increase their environmental focus the upcoming years (Maersk, 2010). Maersk rank the environmental issue as one of the three fundamental challenges the shipping markets is facing (Maersk, 2011).

**6.1.3 Calculating Emissions with Different Speed Levels**

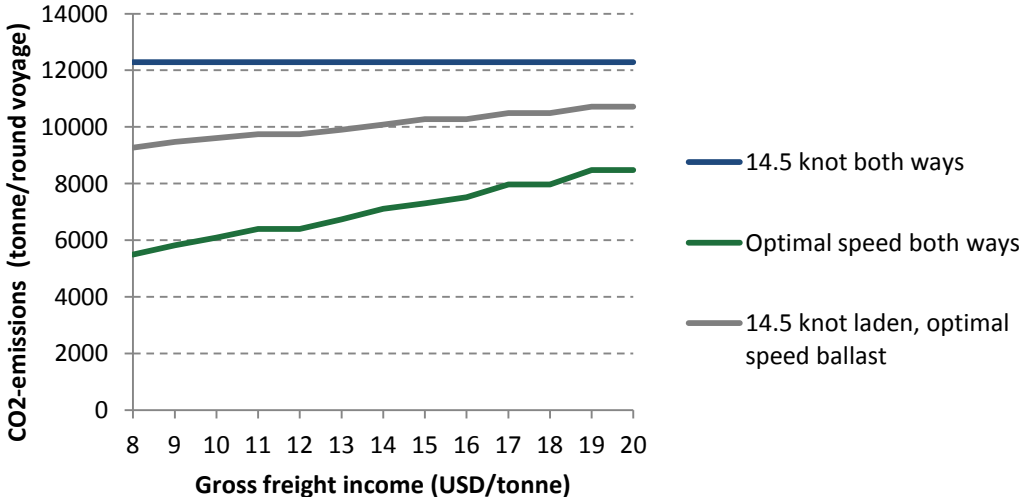
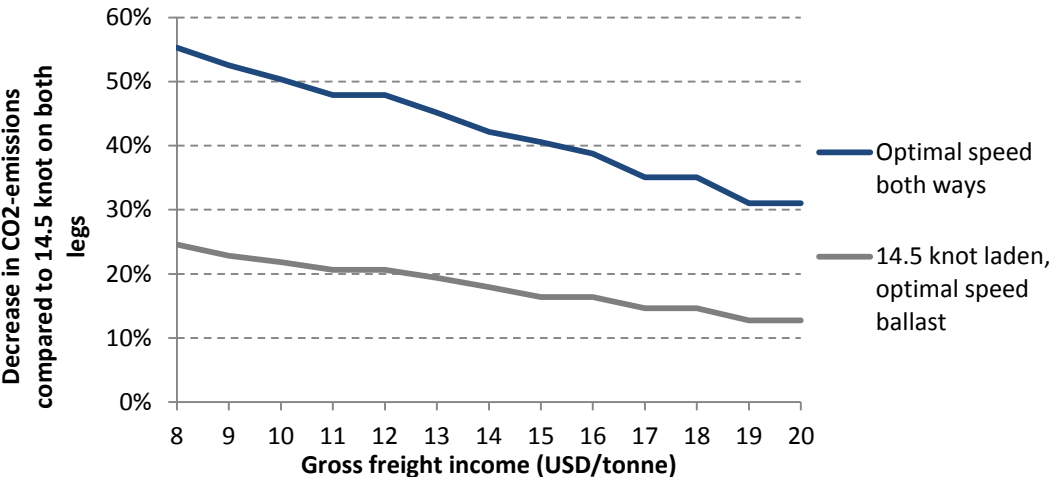

**Figure 6.1** CO<sub>2</sub> emissions with Different Speed Levels (Haugen and own calculations)

<sup>14</sup>Quotation from: Maersk 2010, Slow Steaming Here to Stay. URL address is listed in the bibliography (internet).

The assumptions and calculations behind the figure are described in Appendix I. We see that there are no differences in emission levels when the speed is constant both ways. When the speed is 14.5 knots both ways, there is a constant emission level of approximately 12,300 tonne/round voyage.

However, when we can adjust for optimal speed we see that the emission level increases with increased freight income. We will compare when vessels use optimal speed both ways and when vessels use optimal speed only in ballast. The curve is steeper and the total emission level is lower when optimal speed is used both ways, compared to optimal speed when vessels are in ballast. We see that there are large differences in the emission levels when optimal speed is used both ways, one way and not at all. The next figure will show calculations of the different emission levels when vessel use optimal speed both ways and only in ballast compared to 14.5 knots both ways.



**Figure 6.2** *Decrease in CO2 Emissions Compared to 14.5 Knots Both Ways* (Haugen and own Calculations)

The difference between optimal speed both ways and optimal speed in ballast, compared to 14.5 knots both ways are shown in figure 6.3. When optimal speed is used both ways and the gross freight income is 8 USD/tonne the emissions are more than halved, and when it is 20 USD/tonne the emissions are reduced by 31%. When optimal speed is used only on the ballast leg this percentage is lower compared to optimal speed both ways. At a gross freight income of 8 USD/tonne the decrease is 25%, and is reduced to 13% at a freight income of 20 USD/tonne.



#### **6.1.4 Criticism against Slow Steaming as an Emission Reduction Method**

A study from National Technical University of Greece states that there are different barriers for slow steaming. A factor that does not support slow steaming as an emission reduction method is that slow steaming may result in more ships to match the demand throughput. Eventually, more ships will result in more CO<sub>2</sub> due to shipbuilding and scrapping. This leads to more maritime traffic and causing more emissions (Psaraftis, 2011).

However, a study from Transport and Environment in 2012 states that “a 10% reduction in speed will result in a 19% reduction in CO<sub>2</sub> emissions, even *after* accounting for the emissions of additional ships needed to deliver the same amount of transport work and the emissions associated with building the necessary additional ships” (Faber et al, 2012). In their calculation of emission reduction, they have accounted for the extra CO<sub>2</sub> air pollutions emissions, as well as emissions in connection with steel production and shipbuilding (Faber et al, 2012). It should be mentioned that the presentation in the article reposes on uncertain assumptions.

As analyzed in chapter 4.4, there is still a supply surplus, which means that a lower speed in the current market will not result in a need for more transport capacity. In a situation of oversupply, slow steaming may first result in laid-up ships being taken out, and if it is still not enough supply then an additional ships must be added to the fleet.

On the opposite, Faber et al argues that it is only a time period from 2015-2020 when oversupply can compensate for slow steaming. They conclude that within 2020, there probably will be no overcapacity left because of two reasons; speed reduction will lead to a larger demand for supply, and within 2020 the market will manage to adjust to slow steaming with the orders that are already being placed (Faber et al, 2012).

The studies of emission reductions are still uncertain, with an existing overcapacity in the short term, we can conclude that slow steaming will have positive effects on the environment.

## 6.2 Market Effects

As we have shown in our analysis, with a given price for vessel hire and bunker cost, the total savings will decline when the speed is reduced. For stakeholders this is positive, resulting in an increase in the overall profit.

However, reducing the speed will lead to longer shipping time from A to B. For most freight the increased time will be irrelevant, but some freight has to be delivered as fast as possible because of durability (Nordas et al, 2006). Another reason to ship from A to B quickly is because of the market requirements. When ships speed down, deliveries will arrive later. This may prevent some shipping companies from speeding down, because they know that the charterer will choose another charterer that can deliver the goods earlier (Hummels, 2000). It is difficult to say if market requirements will have an impact on the speed reduction, but other factors will probably be more critical in the slow steaming evaluation. For VLCCs, e.g the financing cost will have a larger impact on the choice of speed (Hummels & Schaur, 2010).

Another factor that may prevent slow steaming from being an industry-standard is the new ordering of more fuel efficient ships. The savings from the new vessels are a result of a more efficient engine, propeller and hull. The significance is distributed equally between these three factors (Finansavisen, 2012). This will increase the competition because new ships may steam at full speed with the same fuel consumption as older ships on lower speeds.

John Fredriksen, shipping's most influential person according to TradeWinds (2012), has stated "He will order vessels that use up to a quarter less fuel, to be able to create a bigger gap to the weaker competitors" (BT, 2012). Besides lower newbuilding costs, new and more fuel efficient vessels are seen as one of the two determining factors for investing in a depressed shipping market (DN, 2012). If fuel efficient vessels become an industry standard for new tanker vessels, slow steaming may in the short run become a necessary way for older ships to obtain the same cost level. However, in the longer run new fuel efficient vessels will obviously make it more difficult to survive in the business and older ships may then eventually be squeezed out (Maersk, 2010). The new fuel saving vessel design has not yet been tested, and the savings are therefore uncertain. DNB Markets believe the effect of the new vessels is overestimated, and express that shipowners should rather wish for higher bunker prices than new vessel design (Finansavisen, 2012). If DNB Markets are right, slow steaming will still be advantageous when the new vessels are launched.

### **6.3 Legal Effects**

Questions around legal issues can arise when it comes to slow steaming. Implementing slow steaming under a time charter party requires a number of legal considerations to be taken into account. The legal aspects mainly concern the owner and his obligations to follow the charterers' slow steaming instructions, while maintaining safety and taking crew, cargo and commitments towards third parties into account (Hunter, 2011). In general, the charterer can influence the speed unless it does not affect any of the abovementioned factors (BIMCO, 2011).

### **6.4 Technical Issues**

Industry players have raised concerns about the ships' engines due to slow steaming. They believed that the engines could break down, since they originally were built to operate at higher speeds. Maersk have voluntarily tested their vessels and engines with low speed. The study showed that slow steaming did not damage the engine. In fact the maintenance costs were reduced because of reduced strain on the engine (Maersk, 2011).

We will still use the main engine maker, MAN, as a standard of reference. MAN is well known with shipowners slow steaming in order to meet the market conditions. In 2009 MAN tested their engines at low loads, and wrote a service letter focusing on possible impacts from consistently reducing vessel speed. The service letter states that long term low load operations are possible without major modifications (MAN, 2009).

The technical issues due to slow steaming are therefore manageable to handle.

### **6.5 Organizational Issues**

Calculating optimal speed is well known in the shipping industry, however many shipping companies still operate their vessels above the optimal speed. Through our work with this dissertation we have spoken to many industry players. The way that they evaluate slow steaming is divided.

Historically, the shipping companies were more integrated before, compared to the specialized shipping companies in today's supply chain. It may be a problem deviating from

the normal service speed because of long “contract-chains”. The source of the problem might be the communication between the different parts within the supply chain. An example of such a long contract-chain may be an owner that charters the vessel to a charterer, and thereafter the charterer sublease it out to an operator who uses the vessel to lift a cargo re-let from another cargo owner to another operator, and so on.

Another factor that may cause difficulties to deviate from normal service speed is the long traditions within shipping. Many operators are old captains who have sailed at normal service speed their whole life. With few exceptions in the 70s, this has been economically optimal until 2004, but as the optimal speed was reduced, old habits die hard. Many operators have not changed their calculations of optimal speed for decades. As these calculations are based on formulas like the cube rule (see section 3.3.1), they are no longer optimal given today’s speed/consumption relationship.

These organizational challenges may be manageable when all operators understand the latent profit from slow steaming. We have already seen that the fleet has reduced its speed the last years (figure 4.11). This may indicate that the operators are starting to optimize speed, even though they are lagging behind.

## 6.6 Piracy

It is almost impossible to avoid mentioning piracy as we talk about shipping challenges in 2012. When the vessel is laden, the freeboard is low which makes it easier for pirates to board the vessels. The low freeboard in addition to the low speed makes tankers an easy target for the pirates. That is why piracy first of all is a problem for low and slow vessels like VLCCs. The problem is, for now, clustered at specific geographic areas (see map beneath), but the attacks are becoming more frequent and brutal than before (ShippingOnline, 2012).



Figure 6.3 Piracy Attacks

(ICC, 2012)

In these times of cost-cutting slow steaming, the threat from pirates is even bigger. VLCCs are too large to transit the Suez Canal and therefore they do not need to operate close to the Somali coast. However, the pirates are now using so called mother ships as a base at sea to increase their range. This means that the threat exists for deep-sea shipping like VLCCs as well. The easiest protection for VLCCs is to increase speed, which makes piracy an issue to optimal speed for the VLCCs. The pirates are in fact forcing the vessels to operate at higher speeds and higher bunker consumption in these specific areas. As the speed is increased in

pirate waters the fuel costs and emissions are significantly higher. To avoid hijacking, higher speed may even be a demand from the insurance companies. Hence, the speed optimization for VLCCs is also threatened by piracy (ShippingOnline, 2012).

## 7. Concluding Remarks

We have in our dissertation answered two research questions. Firstly we have examined the development in the actual and optimal speed of the VLCC fleet the last 4 years. We wanted to find out if the consequences of the financial crisis had affected the optimal speed. In addition we wanted to calculate what the optimal speed is under today's market conditions. Finally, we analyzed the effects of slow steaming on the tanker market.

### *1. How has the actual and optimal speed developed since the financial crisis in 2008?*

In order to meet this aim, we firstly used AIS Live data with adjustments to calculate the historical average speed. We observed that the speed level for the VLCC fleet has decreased with 16.3% from 2008 (15.9 knots) to 2012 (13.3 knots).

To find out what the optimal speed is under the current (May 8) freight rate and bunker price, we presented two speed-optimizing models. In the Haugen model we could separate between when the vessel is laden and in ballast, while the Meyer model only allowed us to find the optimal speed as an average of laden and ballast.

The optimal speed in the Haugen model is 12.5 knots when the vessel is laden and 11 knots when the vessel is in ballast. This is respectively 6.1% and 17.4% below the observed actual speed from AIS Live, May 2012. The optimal speed in the Meyer model is calculated without financing cost, and gives an optimal speed of 9.4 knots, which is 29.4% below the actual level. The average of the two models gives an optimal speed of 11 knots in laden and 10.2 knots in ballast, which is respectively 17.4% and 23.4% below the actual speed.

To quality assess our results we firstly use a model to calculate the cost-minimizing speed, both laden and ballast. The first model is based on TD3 assumptions and provides a speed of 12.3 knots in laden and 10.5 knots in ballast. As an additional test of our results we used a model provided by Frontline and found that Frontline's optimal speed is 12.5 knots laden and 11 knots in ballast. Both results closely coincide with the Haugen model, but the Meyer model deviates much from the results. This makes this the Meyer model less reliable, even though it shows tendencies of reduced speed under current conditions. In total, our findings indicate that the fleet will gain from further decreasing the speed.

Further in our dissertation we presented the potential savings from sailing at optimal speed compared to full speed. We presented our results in a matrix showing that under today's conditions, a vessel can save almost 33,000 USD/day if it reduces the speed from 16.4 knots (full speed) to 11 knots. The savings may be slightly overrated because we have included the Meyer model, which we believe overestimates the potential savings.

The results from our analysis show that both the actual and optimal speed has decreased. Our speed optimizing models show that the optimal speed still is below the actual speed for VLCCs. Under the current market conditions, our findings suggest that the VLCC fleet should continue to slow steam to increase profits.

## *2. How does slow steaming affect the tanker shipping segment?*

To answer our second research question we have analyzed the effects of slow steaming on different parts of the tanker segment. Our main focus was on the environmental aspects because this topic has become more relevant for shipping actors in the recent years. In our analysis we have calculated that lower speed will have several positive effects through reduced CO<sub>2</sub> emissions, and that optimal speed in fact could reduce emissions with over 50% compared to full speed. Other aspects presented were market, technical, organisational, legal and piracy effects. Different problems may arise concerning these issues. The most important challenge may be new and more fuel efficient ships, which may phase out older vessels that are slow steaming. However, the fuel savings are still uncertain, and because of long and expensive construction time it could take many years before it is relevant to our results. As for the other aspects, we conclude that they are manageable to handle for charterers and shipowners.

We believe that slow steaming, under current conditions, is an effective way to increase profit, balance supply surplus and give a new boost to the tanker market. However, the volatile markets make it difficult to estimate how the tanker segment will develop the next years. As the oil price is expected to stay high and few actors expect a recovery in the tanker market in the immediate future, we believe slow steaming will become even more relevant in the years to come.



## **Bibliography**

The bibliography is listed in an alphabetic order.

### **Articles**

Alvarez et al, 2010. *A methodology to assess vessel berthing and speed optimization policies*, Maritime Economics & Logistics.

Alvik et al, 2010. *Pathways to low carbon shipping: Abatement potential towards 2030*, DNV.

Andersen, E. M.. 2008. *The Tanker Market*, RS Platou.

Beenstock, M., 1985. *A theory of ship price*, Maritime Policy and Management.

Bergh, I., 2010. *Optimum speed – from a shipper’s perspective*, DNV.

BIMCO, 2011. *Slow Steaming Clause for Time Charter Parties*, Special Circular no. 7.

BIMCO, 2012. *The average age of demolished crude oil tankers hits 21 – not much room left for demolition balancing the market!*, The Baltic and International Maritime Council - Market Analysis report 2012.

Blackley, N.,1981. *Slow Steaming Analysis: Tanker Optimum Speeds – Slow Steaming should be stop steaming*, Lloyd’s Shipping Economist, Vol. 3.

Brown et al. 2007. *Steaming on convex hulls*. Interfaces, Vol. 37, No. 4.

Cariou, P., 2011. *Is Slow Steaming a sustainable means of reducing Co2 emissions from container shipping*, Transportation Research.

Cullniane, K. and Khanna, M., 2000. *Economies of Scale in large Containerships; Optimal size and geographical implications*, Journal of transport geography, Vol 33.

Dalsøren et al, 2009. *Update on emissions and environmental impacts from the international fleet of ships: the contribution from major ship types and ports*, Atmospheric Chemistry and Physics 9.

Dalsøren, S.B., 2011. *Future cost scenarios for reduction of ship CO2 emissions*, Maritime Policy and Management 38.

Delfi Consultants, 2012. *Regulated Slow Steaming in Maritime Transport; An assessment of options, costs, and benefits*, Transport and Environment and Seas at Risk.

Devanney, J., 2010. *The Impact of Bunker Prices on VLCC Spot Rates*, Center for Tankship Excellence.

DN, 2012. *Verdens mektigste i shipping*, Dagens Næringsliv paper 06.01.2012.

DNB Markets, 2011. *Re-initiation of coverage – Frontline - Ship Finance likely to take the largest beating*.

DNB Markets, 2011. *Mount Kilimanjaro has become Galdhøpiggen*.

DNB Markets, 2012. *Economic Outlook 2012*.

DNV, 2010. *Assessment of measures to reduce future CO2 emissions from shipping*. DNV.

Dings, J., 2012. *Smarter steaming ahead*. Transport & Environment.

European Marine Safety Agency/ Equasis database, 2011, *The World Merchant Fleet*, EMSA.

Faber et al, 2009. *Technical support for European action to reducing Greenhouse Gas Emissions from international maritime transport*. Deft: CE Delft.

Faber et al, 2010. *Going slow to reduce emissions: Can the current surplus of maritime transport capacity be turned into an opportunity to reduce ghg emissions?.* Seas at Risk.

Faber et al, 2012. *Regulated Slow Steaming in Maritime Transport - An Assessment of Options, Costs and Benefits*. Transport and Environment.

Faltinsen et al, 1980. *Prediction of Resistance and Propulsion of a Ship in a Seaway*. In Proc. Thirteenth Symp. on Naval Hydrodynamics, The Shipbuilding Research Association of Japan.

Finansavisen, 2012. *Med Vekst i Tankene*. Finansavisen paper edition 06.01.2012.

Finansavisen, 2012. *Krisen i Shipping. Tror mest på lav seilingsfart*. Finansavisen paper edition 06.08.2012.

Freight Metrics, 2003. *Risk Management in Shipping*, National Technical University of Athens School of Naval Architecture & Marine Engineering.

Frontline, 2011. Annual report.

Gudehus, T., 2010. *Die kostenoptimale Geschwindigkeit von Frachtschiffen*, Schiff & Hafen. (As referred to in Meyer et al., 2012)

Hummels, D., 2007. *Transportation Costs and International Trade in the Second Era of Globalization* *Journal Economic Perspectives*, Vol 21, No 3.

Hummels, D., 2000. *Time as a trade barrier*, Purdue Ciber Working paper Paper 7.

Hummels, D. and Schaur, G., 2010. *Hedging price volatility using fast transport*, *Journal of International Economics*, Number 82.

Hunter, G., 2011. *BIMCO Slow Steaming Clause for Time Charter Parties*, BIMCO.

IMO - World Maritime Day, 2006. *International Shipping Carrier of World Trade: Promoting technical co-operation to ensure the efficiency, safety and environmental*

*performance of the global shipping industry*, Bimco, Intercargo, International Chamber of Shipping / International Shipping Federation and Intertanko.

Klovland, J. T., 2011. *Money and Banking*. Bergen, Lectures at NHH.

Kontovas, C. and Psaraftis, H., 2012. *The Link Between Economy and Environment in the Post-Crisis Era: Lessons Learned from Slow Steaming*, National Technical University of Athen.

Lloyds Shipping Economist, 2011. *The Big Squeeze*, Lloyds Shipping Economist.

Maersk, 2010. *Maersk Line equipment guide*, Maersk Line containers.

Maersk Line, 2010. *Slow Steaming is here to stay*. Press report.

Maersk Line, 2011. *Daily Maersk - An answer to an industry challenge*, Press report.

Maersk, 2011. Annual report.

MAN, 2011. *Basic Principles of Ship Propulsion*, MAN Engines.

Meyer et al., 2012. *Slow Steaming in Container Shipping*, Hawaii International Conference on System Sciences.

Nordea Markets, 2012. *Oil Market Monthly January*.

Nordas et al, 2006. *Logistics and Time as a Trade Barrier*, OECD Publishing, No 35, Working Paper.

Normann, V. and Wergeland, T., 1979. *Oil prices and world shipping*, Platou Report 1979.

Notteboom, T. and Carriou, P., 2011. *Bunker Costs in Container Liner Shipping: Are Slow Steaming Practices Reflected in Maritime Fuel Surcharges?* Port Economics.

Poulsen, R. T.. *Emissions and energy efficiency – the twin challenges for shipping*, Center for Shipping Economics and Innovation Copenhagen Business School.

Psaraftis, H.N. and Kontovas, C.A., 2009. *CO2 Emission Statistics for the World Commercial Fleet*. Laboratory for Maritime Transport, National Technical University of Athens.

Psaraftis, H.N., Kontovas, C.A., 2008. *Ship emission study*. Prepared by National Technical University of Athens Laboratory for Maritime Transport.

Reuters, 2011. *EU-Watchdogs raid Maersk and other liner Shippers*, Reuters news.

Ronen, D., 2011. *The effect of oil price on containership speed and fleet size*, Journal of Operational research society, No 62.

Platou, 2007. *The Platou Report 2007*, RS Platou Annual Shipping Report.

Platou, 2008. *The Platou Report 2007*, RS Platou Annual Shipping Report.

Platou, 2009. *The Platou Report 2007*, RS Platou Annual Shipping Report.

Platou, 2010. *The Platou Report 2007*, RS Platou Annual Shipping Report.

Platou, 2011. *The Platou Report 2007*, RS Platou Annual Shipping Report.

Platou, 2012. *Market Monthly: January, February, March, April and May*.

Platou, 2012. *Shipping Quarterly*, Platou Research June 2012.

Strandenæs, S. P., 2011. *Shipping Economics*. Bergen, Lectures at NHH.

Tenold, S., 2012. *“I Have Always Been Here Before.” Lessons from the Last Crisis in the Shipping Sector*, Norwegian School of Economics.

U.S. Department of Transportation, 2008. *Glossary of Shipping Terms*, Maritime Administration

United Nations (UNCTAD), 2010. *Oil price and freight rates; an empirical investigation*, United Nations Conference on Trade and Development

United Nations (UNCTAD), 2011. *Review of Maritime Transport*, United Nations Conference on Trade and Development

United Nations (UNCTAD). 2012, *Review of Maritime Transport*, United Nations Conference on Trade and Development

Wang, S. and Meng, Q, 2012. *Sailing Speed Optimization for containerships in a liner ship network*, Transport research.

## **Books**

Cullinane, K., 2011. *International Handbook of Maritime Economics*. Cheltenham: Edward Elgar Publishing Limited.

Hillier et al, 2010. *Corporate Finance*, Berkshire: Mc Graw Hill.

Kavussanos, M. and Visvikis, I., 2006. *Derivatives and risk management in shipping*, 1st edition. Livingston: Witherby Seamanship International.

Lun et al, 2010. *Shipping and Logistics Management*. Hong Kong: Springer.

Massey, B. and Ward-Smith, A., 2011. *Mechanics of Fluids*. London; New York: Spoon Press.

Stopford, M., 2009. *Maritime Economics*. New York: Routledge.

## **Databases**

Clarksons, 2012. *Clarksons database*, (NHH-given access).

SEB Enskilda, *Bloomberg Terminal*.

RS Platou Research, *Internal Data*.

## **Internet**

Baltic Exchange, 2012

Available at: <http://www.balticexchange.com/default.asp?action=article&ID=4006>

Accessed 05.14.2012

Calvert, J.B., 2000. *Bernoulli's equation*

Available at: <http://mysite.du.edu/~jcalvert/tech/fluids/bernoul.htm>

Accessed 04.10.2012

BT, Bergens Tidende, 2012. "*Skrik*" var for dyrt

Available at: <http://www.bt.no/nyheter/okonomi/John-Fredriksen-Skrik-var-for-dyrt-2700291.html#.T6k9VJ91B3t>

Accessed: 05.08.2012

Dundas, B., 1999. *Newton's method*

Available at: <http://www.math.ntnu.no/~dundas/SIF5003/u3/newt/syst.html>

Accessed 04.10.2012

Exxon Mobile, *The Valdez Oil Spill*

Available at: [http://www.exxonmobil.com/Corporate/about\\_issues\\_valdez.aspx](http://www.exxonmobil.com/Corporate/about_issues_valdez.aspx)

Accessed 02.05.2012

Holmvang, P., 2008, *Environmental performance and the future*, DNV

Available at:

[http://www.dnv.no/din\\_bransje/maritime/publikasjoner/publications/dnvcontainershipupdate/2008/2-2008/environmentalperformance.asp](http://www.dnv.no/din_bransje/maritime/publikasjoner/publications/dnvcontainershipupdate/2008/2-2008/environmentalperformance.asp)

Accessed: 05.04.2012

Lloyd's List, 2012. *Tanker owners must do more to calculate optimum sailing speeds*,  
McQuilling Services

Available at: <http://www.lloydslist.com/ll/sector/tankers/article400330.ece>

Accessed 06.08.2012

Marinetraffic, 2012. *FAQ*

Available at: <http://www.marinetraffic.com/ais/faq.aspx?level1=160>

Accessed 04.18.2012

Maersk, 2010. *Slow steaming here to stay*.

Available at: <http://www.maersk.com/AboutMaersk/News/Pages/20100901-145240.aspx>

Accessed: 01.02.2012

MAN Service letter 2009, *Low Load Operations*

<http://www.ancomaritime.com/page5/page6/files/MAN%20SL2009-511.pdf>

Accessed 05.02.2012

Maersk, 2011. *No damage by slow steaming*

<http://www.joc.com/container-shipping/maersk-study-shows-slow-steaming-doesnt-hurt-engines>

Accessed 05.04.2012

RS Platou 2012, *T/C Converter*

Available at: <http://reports.platou.com/wc2/default.aspx>

Accessed 01.06.2012



Piracy attacks, 2012. *IMB Piracy & Armed Robbery Map 2012*

Available at: <http://www.icc-ccs.org/piracy-reporting-centre/live-piracy-map>

Accessed 05.09.2012

Psaraftis, H.N., 2011. *Slow steaming vs. speed limits*. Laboratory for Maritime Transport, National Technical University of Athens, Greece

Available at:

<http://www.martrans.org/documents/2011/Slow%20steaming%20Psaraftis%202011.pdf>

Accessed at: 05.06.2012

Shipping Online, 2012. *Somali Pirates force Boxships to abandon cost-cutting slow steaming*

Available at: <http://www.shippingonline.cn/news/newsContent.asp?id=19296>

Accessed 05.07.2012

Stopford, D. M., 2011. *Thoughts about Slow Steaming and Rising Oil Prices*

Available at:

[www.clarksons.net/markets/feature\\_display.asp?section=&news\\_id=31165&title=Thoughts+about+Slow+Steaming+and+Rising+Oil+Prices](http://www.clarksons.net/markets/feature_display.asp?section=&news_id=31165&title=Thoughts+about+Slow+Steaming+and+Rising+Oil+Prices)

Accessed 03.01.2012

Worldscale, 2012. *Introduction to Worldscale Freight Rate Schedules*

Available at: <http://www.worldscale.co.uk/company%5Ccompany.htm>

Accessed 02.20.2012

Wright, R., 2012. *Frykter Krise-reprise i tankmarkedet*

Available at: <http://www.dn.no/forsiden/borsMarked/article2363478.ece>

Accessed: 03.28.2012

## **Interviews**

Asheim, P. G., 2012. *Director of Operations - Frontline Ltd. Excel-model: Optimal speed for Frontline Tankers* (25.04.2012).

Haugen, P., 2011. *Shipping Analyst* (continously correspondation).

Kollenborg, J. C., 2012. *Operation Manager – Commercial Operations Suezmax - Frontline Ltd.* (25.04.2012).

Mantell, C., 2012. *Oil Analyst*. Clarksons Research Services (24.04.2012).

Ringheim, J., 2012. *Shipping Analyst*. RS Platou Markets (23.03.2012).

Stenhagen, O. G., 2012. *Shipping Analyst*. SEB Enskilda (22.12.2011).

Tollefsen, T., 2011. *Shipping Analyst*. SEB Enskilda (continously correspondation).

# Appendices

## Appendix A: Indication of a Ship's Size

Throughout our master thesis we have used different shipping related terms. We will in this section give a brief description of some of the most common terms. In figure A the “Plimsoll Mark” is illustrated at the ship’s side. The Plimsoll Mark indicates at which level the vessel may be safely loaded. These freeboard rules are statutory rules by the IMO (International Maritime Organization), and they are dependent of temperature (season) and type of water. When the ship is loaded to the legal mark, we say the ship is “loaded to its marks” (MAN, 2011).

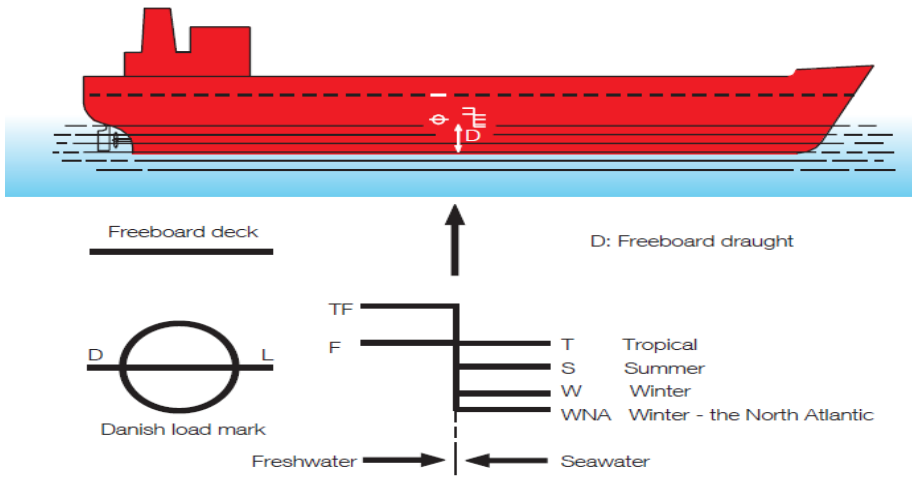

**Figure A** Load Lines – Freeboard Draught (MAN, 2011)

In shipping the vessels are measured in size in many different ways. There are many commercial reasons to the multiple units of measurement in shipping. The most common measurements are explained in section 1.4. Beneath we have explained other measurements that are not as commonly used.

When a vessel is loaded to its marks, its *displacement* equals the mass of water displaced by the ship. Hence the displacement is equal to the total weight of the loaded ship in seawater. The *lightweight* of a ship equals the vessel’s weight as it is built. Other measurements of the ship size are described in the shipping glossary at the beginning of the thesis.

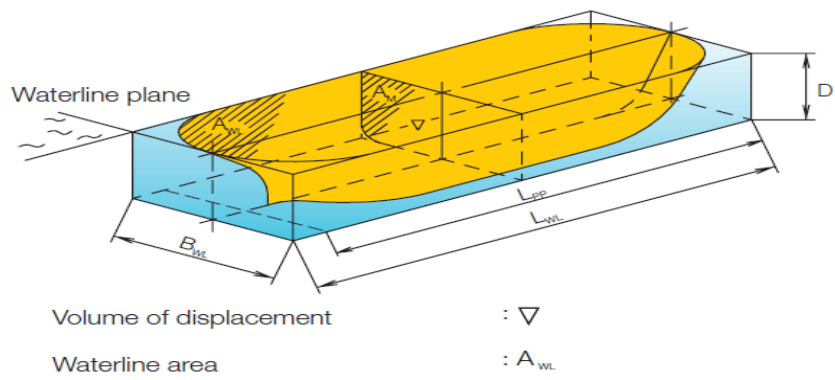

**Figure B** *Hull Dimensions*

(MAN, 2011)

The figure above illustrates a hull and how it is dimensioned.

## Appendix B: Basic Principles of Ship Propulsion

Every vessel within shipping today gains its speed mainly from a propeller which is powered by an engine that burns bunker. To be able to understand the connection between the input of bunker and the output of power, in the form of steaming speed, it is necessary to briefly explain the physical forces that a vessel is exposed to. The energy from the bunker is not only transformed to pure forward thrust. The primary source for a vessel is its engine, and the forward thrust is highly dependent on the ship's hull and the propeller design (Stopford, 2009).

### General

The basic principles of ship propulsion are explained in several books and articles. However, we will in this section use a to-the-point article written by the main engine maker in shipping, MAN.<sup>15</sup>

A vessel's resistance is in general influenced by its hull form, displacement and speed. It is common to divide the ship's resistance into three source-resistance groups.

1. Frictional resistance ( $R_F$ )
2. Residual resistance ( $R_W + R_E$ )
3. Air resistance ( $R_A$ )

Frictional and residual resistance depend on how much of the hull that is below the waterline (wetted hull), while the air resistance depends on how much of the hull that is above the waterline. With that, air resistance will especially have an effect on container ships that carries numerous amounts of containers on deck. For a ship to gain speed, it first needs to defeat any resistance, which are forces working against its forward thrust.

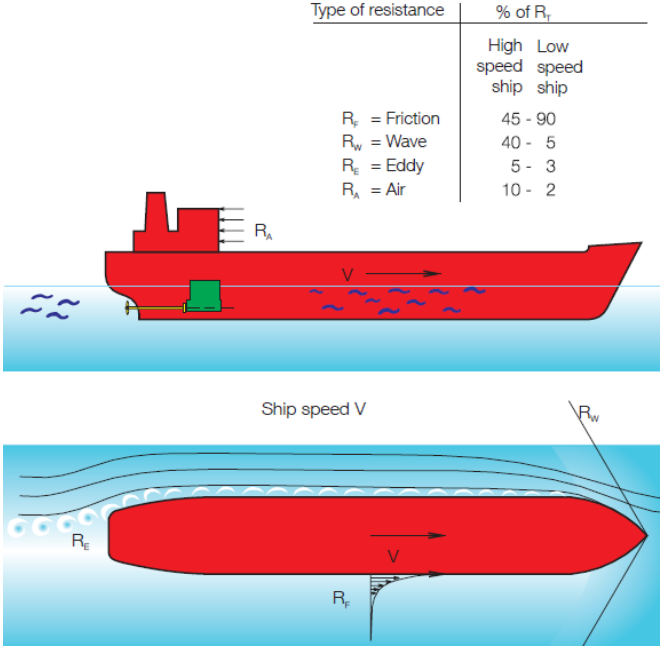

Figure C A Ship's resistance (MAN, 2011)

<sup>15</sup> <http://mandieselturbo.com/1005405/Press/Publications/Technical-Papers/Marine-Power/Low-Speed/Ship-Propulsion.html>

### ***Frictional Resistance***

The frictional resistance of the hull depends on the wetted area and the hull's roughness/frictional resistance. In the course of time the ship's hull below the waterline will be object of marine growth which increases frictional resistance. In extreme cases this may reduce achievable speed by 2-3 knots (Stopford, 2009). The fouling that increases the friction may for example be growth of algae, sea grass and barnacles. A rule of thumb for ships is that the frictional resistance increases at a rate approximately equal to the square of the speed. From the table at the top right of figure C we can see that the frictional resistance accounts for a considerable part of the total resistance ( $R_T$ ). As the vessel reduces speed and starts to slow steam the frictional resistance accounts for as much as 90% of the total resistance (MAN, 2011).

### ***Residual Resistance***

The residual resistance is compounded of wave resistance ( $R_W$ ) and eddy resistance ( $R_E$ ). The wave resistance occurs as a counter force during the ship's propulsion through the water and equals the loss of energy by moving through the water and creating waves. The eddy resistance is due to the loss in forward thrust from flow separation which creates eddies. The wave resistance is particularly at the bow of the ship, while the eddy resistance is at the aft of the ship. The residual resistance represents 8-25% of the total resistance when the ship is slow steaming, while this percentage increases up to 40-60% of the total resistance for high-speed ships (MAN, 2011).

### ***Air Resistance***

For low-speed ships the air resistance amount to approximately 2% of the total resistance, while it is 10% for high-speed ships. Still, this is highly dependent on ship type and how much head wind the ship is facing at any time.

In general, the resistance is very volatile as a consequence of changing weather conditions at sea. As an example, the total resistance in head-sea can increase as much as 50% - 100% compared to calm weather. During the lifetime of a ship, fouling may increase the resistance by 25% - 50%. Even though the total resistance is reduced when the speed is reduced, MAN restricts the speed downwards with a minimum of 10% engine load. In line with MAN guidelines we will also restrict the speed at 10% engine load (MAN, 2011).

## **Appendix C: Understanding Bunker Fuel**

Since bunker fuel is used as a term throughout our dissertation, an elaborated explanation is added to the appendix. The term bunker fuel is used in many different settings, but it is a lot of confusion regarding the relationship between crude oil and the fuel price. In short, the oil price is given per barrel, while the bunker price is given per tonne. The barrel/tonne (bbl/tonne) relationship is approximately 6.35 for 380cSt at 30°C (86°F) (Bunkerworld, 2012). To approach this problem, we have used a “Bunker Fuel Multiplier” (bbl/tonne) equal to 6 in our dissertation.

In general, bunker fuel is what is left after the refineries have subtracted all the valuable fuel from the crude oil. The bunker fuel is not very viscous, and this is why it must be heated before it can be burned in an engine. Large vessels, like VLCCs, have a large fuel capacity and engines that can handle the bunker fuel. These are the reasons why large vessels are appropriate to use bunker fuel as engine fuel (Tollefsen, 2012).

## Appendix D: Assumptions to Calculate Optimal Speed with the Haugen Model

To calculate the optimal speed we have taken necessary assumptions. These assumptions are an intake of 2m barrels (or 265,000 tonnes) crude oil, a finance cost of 3.5% (YTD average LIBOR and an additional 3% margin).

Further we will use the AIS reported normal service speed for VLCCs and the connected bunker consumption from Clarksons Database. This is a fuel consumption of 92 tonnes/day and a speed of 15.9 knots. In addition, we will assume that the normal service speed is at a 90% engine load. With a normal service speed of 15.9 knots (at 90% engine load), the maximum speed will be 16.4 knots. At 15.9 knots (laden), the fuel consumption is 92 tonne/day (Clarksons Database, 2012). Regarding the engine load, we will restrict it downwards to 10% which equals 5 knots. This is in line with engine load restrictions made by the main engine maker, MAN (MAN, 2012). The restriction is made due to technical problems that will possibly occur at lower engine loads. When the vessel is in ballast, a 90% engine load increases the normal service speed by 0.5 knots, which gives a maximum speed in ballast equal to 16.9 knots.

For simplicity we will not include weather factors, bunker consumption in port and commissions.

The assumptions are listed beneath:

### ***Assumptions Optimal Speed - The Haugen Model***

---

Normal speed laden**	15,9 knot
Normal speed ballast**	16,4 knot
Engine load - normal speed	90 %
Engine load - minimum	10 %
Normal consumption	92 tonne/day
Bunker consumption exponent (MAN)	3,2 n
Intake (barrels)	2 m
Intake (tonne)	265 000 tonne
Oil price*	117 USD/barrel
Net bunker price*	700 USD/tonne
380 cSt barrels in a metric tonne	6 bbl/tonne
YTD average LIBOR*	0,7 %
Margin	3 %
Financing cost	3,7 %

\*: Data gathered 8th May

\*\*.: Reported normal service speed

---

Source: Clarksons Database



## Appendix E: Assumptions to Calculate Optimal Speed with the Meyer Model

Most of the assumptions for this formula are the same as the Haugen model. This is since we use Clarksons Database as a standard of reference. This makes the basis for comparison the same. Even though most of the assumptions are the same, the input in the models is different. Since the Meyer model is dependent on a profit function, costs per trip must be calculated. The formula is dependent on a port cost. The port cost is set to 50,000 USD per day in accordance with data from the Baltic Exchange. The minimum fuel consumption,  $FC_{min}$  (described in 3.2.4), is set to 10 tonne/day. This is in accordance with a minimum speed equal to 5 knots at 10% engine load (see appendix D for details). Further a new constant,  $C_F$ , is added.  $C_F$  is calculated by using equation (16).

$$FC_{nm} = FC_{min} + C_F \cdot v^n$$

$$FC_{nm} = \frac{\text{normal consumption (kg/day)}}{\text{nm per day}} = \frac{92,000 \text{ kg/day}}{15,9 \text{ kt} \cdot 24 \text{ Hours}} = 241,09 \dots$$

If we use  $FC_{min} = 10$ ,  $v^n = 15.9^{3.2}$  and solve (16) with regard to  $C_F$ , we get  $C_F \approx 0.033$ .

### Assumptions Optimal Speed - The Meyer Model

Normal speed laden**	15,9 knot
Normal speed ballast**	16,4 knot
Normal consumption	92 tonne/day
Minimum fuel consumption	10 tonne/day
Bunker consumption exponent (MAN)	3,2 n
Fuel coefficient	0,033 $C_F$
Distance TD3 (both ways)	13 305 miles
Port cost load	50 000 USD
Port cost discharging	50 000 USD
Port days	2 days
Oil price*	117 USD/barrel
Net bunker price*	700 USD/tonne
380 cSt barrels in a metric tonne	6 bbl/tonne

\*: Data gathered 8th May

\*\* : Reported normal service speed

Source: Baltic Exchange, Clarksons Database

## Appendix F: Assumptions in Voyage Example

To be able to illustrate the optimal speed laden and in ballast, we have made some assumptions. These are as follows; distance 6,650 miles one way, bunker price 700 USD/tonne, TC-rate 22,500 USD/day, intake of 265,000 tonnes (2m barrels) oil and a financing cost of 3.7% (3mth LIBOR and a margin of 3%). Speed and consumption are the same as assumed earlier. The assumptions listed are:

### ***Assumptions Voyage example***

---

Normal speed laden	15,9 knot
Normal speed ballast	16,4 knot
Consumption at normal speed laden	92 tonne/day
Distance one way	6 650 miles
TC-rate	22 500 USD/day
Port cost load*	50 000 USD
Port cost discharging*	50 000 USD
Port days load	2 days
Port days discharging	2 days
Financing cost*	3,7 %
Intake	265 000 tonne
Net bunker price*	700 USD/tonne

\*: Data gathered 8th May

\*\* : variable in calculations shown

---

Source: Clarksons Database, The Baltic Exchange

## Appendix G: Savings from Optimal Speed

The savings presented are from choosing optimal speed, rather than maximum speed. The matrices are based on the same assumptions as in Appendix C. To find the savings *per mile* we simply subtracted the total costs at optimal speed from the total costs at maximum speed. Savings *per day* were then found by multiplying the savings per mile with the optimal speed and 24 hours. This way of calculating the savings applies to both the Haugen and the Meyer model.

### The Haugen Model

#### *Savings in USD/mile – Laden*

Bunker price [\$/ton]	TC rates [\$/day]																			
	2500	5000	7500	10000	12500	15000	17500	20000	22500	25000	27500	30000	32500	35000	37500	40000	42500	45000	47500	50000
100	5,8	3,8	2,5	1,5	0,8	0,3	0,1	0,0	0,0	0,0	0,0	0,0	0,0	0,0	0,0	0,0	0,0	0,0	0,0	0,0
150	10,0	7,6	5,8	4,3	3,1	2,2	1,5	0,9	0,5	0,2	0,1	0,0	0,0	0,0	0,0	0,0	0,0	0,0	0,0	0,0
200	14,2	11,6	9,5	7,7	6,2	4,9	3,8	2,9	2,2	1,6	1,1	0,7	0,4	0,2	0,0	0,0	0,0	0,0	0,0	0,0
250	18,5	15,7	13,4	11,4	9,6	8,1	6,8	5,6	4,6	3,7	2,9	2,2	1,7	1,2	0,8	0,5	0,3	0,1	0,0	0,0
300	22,8	19,9	17,4	15,2	13,3	11,5	10,0	8,6	7,4	6,3	5,3	4,4	3,6	2,9	2,3	1,8	1,4	1,0	0,7	0,4
350	27,1	24,1	21,5	19,2	17,1	15,2	13,5	11,9	10,5	9,2	8,0	7,0	6,0	5,1	4,4	3,7	3,0	2,5	2,0	1,5
400	31,4	28,4	25,7	23,2	21,0	19,0	17,1	15,4	13,8	12,4	11,1	9,8	8,7	7,7	6,7	5,9	5,1	4,4	3,7	3,1
450	35,7	32,6	29,9	27,3	25,0	22,8	20,9	19,0	17,3	15,7	14,3	12,9	11,7	10,5	9,4	8,4	7,5	6,6	5,8	5,1
500	40,0	36,9	34,1	31,5	29,0	26,8	24,7	22,8	20,9	19,2	17,7	16,2	14,8	13,5	12,3	11,2	10,1	9,1	8,2	7,3
550	44,4	41,2	38,3	35,6	33,1	30,8	28,6	26,6	24,7	22,9	21,2	19,6	18,1	16,7	15,4	14,1	13,0	11,9	10,8	9,9
600	48,7	45,5	42,6	39,8	37,2	34,8	32,6	30,4	28,4	26,6	24,8	23,1	21,5	20,0	18,6	17,2	16,0	14,8	13,6	12,5
650	53,0	49,8	46,8	44,0	41,4	38,9	36,6	34,4	32,3	30,3	28,5	26,7	25,0	23,4	21,9	20,5	19,1	17,8	16,6	15,4
700	57,4	54,1	51,1	48,3	45,6	43,0	40,6	38,4	36,2	34,2	32,2	30,4	28,6	26,9	25,3	23,8	22,4	21,0	19,7	18,4
750	61,7	58,5	55,4	52,5	49,8	47,2	44,7	42,4	40,2	38,1	36,0	34,1	32,3	30,5	28,9	27,3	25,7	24,3	22,9	21,5
800	66,1	62,8	59,7	56,8	54,0	51,3	48,8	46,5	44,2	42,0	39,9	37,9	36,0	34,2	32,5	30,8	29,2	27,7	26,2	24,8
850	70,4	67,1	64,0	61,0	58,2	55,5	53,0	50,5	48,2	46,0	43,8	41,8	39,8	37,9	36,1	34,4	32,7	31,1	29,6	28,1
900	74,7	71,4	68,3	65,3	62,4	59,7	57,1	54,6	52,3	50,0	47,8	45,7	43,7	41,7	39,8	38,0	36,3	34,6	33,0	31,5
950	79,1	75,8	72,6	69,6	66,7	63,9	61,3	58,8	56,3	54,0	51,8	49,6	47,5	45,5	43,6	41,7	40,0	38,2	36,6	35,0
1000	83,4	80,1	76,9	73,9	71,0	68,2	65,5	62,9	60,4	58,1	55,8	53,6	51,4	49,4	47,4	45,5	43,7	41,9	40,2	38,5

#### *Savings in USD/mile – Ballast*

Bunker price [\$/ton]	TC rates [\$/day]																			
	2500	5000	7500	10000	12500	15000	17500	20000	22500	25000	27500	30000	32500	35000	37500	40000	42500	45000	47500	50000
100	9,9	6,5	4,4	2,8	1,7	1,0	0,5	0,2	0,0	0,0	0,0	0,0	0,0	0,0	0,0	0,0	0,0	0,0	0,0	0,0
150	17,2	12,8	9,8	7,5	5,7	4,2	3,1	2,2	1,5	0,9	0,5	0,2	0,1	0,0	0,0	0,0	0,0	0,0	0,0	0,0
200	24,8	19,7	16,0	13,1	10,7	8,7	7,1	5,7	4,5	3,5	2,6	2,0	1,4	0,9	0,6	0,3	0,1	0,0	0,0	0,0
250	32,6	26,9	22,6	19,2	16,3	13,9	11,8	10,0	8,5	7,1	5,9	4,8	3,9	3,1	2,4	1,9	1,4	1,0	0,6	0,4
300	40,5	34,3	29,6	25,7	22,4	19,6	17,1	15,0	13,1	11,4	9,9	8,5	7,3	6,2	5,2	4,4	3,6	2,9	2,3	1,8
350	48,6	41,9	36,7	32,4	28,8	25,6	22,9	20,4	18,2	16,2	14,4	12,7	11,3	9,9	8,7	7,6	6,6	5,7	4,8	4,1
400	56,6	49,6	44,0	39,4	35,4	32,0	28,9	26,1	23,6	21,4	19,3	17,4	15,7	14,1	12,7	11,3	10,1	9,0	7,9	7,0
450	64,7	57,4	51,5	46,5	42,3	38,5	35,2	32,1	29,4	26,9	24,6	22,5	20,5	18,7	17,1	15,5	14,1	12,7	11,5	10,4
500	72,9	65,2	59,0	53,8	49,3	45,2	41,6	38,4	35,4	32,7	30,1	27,8	25,7	23,7	21,8	20,0	18,4	16,9	15,5	14,2
550	81,2	73,1	66,7	61,2	56,4	52,1	48,3	44,8	41,6	38,6	35,9	33,4	31,0	28,9	26,8	24,9	23,1	21,4	19,8	18,3
600	89,5	81,1	74,4	68,6	63,6	59,1	55,0	51,3	47,9	44,8	41,9	39,2	36,7	34,3	32,1	30,0	28,0	26,1	24,4	22,7
650	97,8	89,1	82,2	76,2	70,9	66,2	61,9	58,0	54,5	51,1	48,0	45,1	42,4	39,9	37,5	35,3	33,1	31,1	29,2	27,4
700	106,1	97,1	90,0	83,8	78,3	73,4	69,0	64,9	61,1	57,6	54,3	51,3	48,4	45,7	43,2	40,8	38,5	36,3	34,3	32,4
750	114,5	105,2	97,8	91,5	85,8	80,7	76,1	71,8	67,8	64,2	60,7	57,5	54,5	51,7	49,0	46,4	44,0	41,7	39,5	37,5
800	122,8	113,3	105,7	99,2	93,3	88,1	83,2	78,8	74,7	70,9	67,3	63,9	60,8	57,8	54,9	52,2	49,7	47,3	45,0	42,7
850	131,1	121,4	113,7	106,9	100,9	95,5	90,5	85,9	81,6	77,7	73,9	70,4	67,1	64,0	61,0	58,2	55,5	53,0	50,5	48,2
900	139,5	129,5	121,6	114,7	108,6	103,0	97,8	93,1	88,7	84,5	80,7	77,0	73,6	70,3	67,2	64,3	61,5	58,8	56,2	53,8
950	147,9	137,6	129,6	122,6	116,2	110,5	105,2	100,3	95,7	91,5	87,5	83,7	80,1	76,7	73,5	70,4	67,5	64,7	62,0	59,5
1000	156,2	145,7	137,6	130,5	124,0	118,1	112,6	107,6	102,9	98,5	94,4	90,5	86,8	83,2	79,9	76,7	73,7	70,8	68,0	65,3

### Savings in USD/day – Laden

Bunker price	TC rates [\$/day]																			
	2500	5000	7500	10000	12500	15000	17500	20000	22500	25000	27500	30000	32500	35000	37500	40000	42500	45000	47500	50000
100	1702	1218	823	514	283	125	32	0	0	0	0	0	0	0	0	0	0	0	0	0
150	2821	2297	1828	1418	1067	771	528	334	187	84	22	0	0	0	0	0	0	0	0	0
200	3946	3404	2899	2437	2020	1647	1317	1028	779	567	391	250	141	64	18	0	0	0	0	0
250	5072	4521	3996	3504	3046	2624	2238	1887	1570	1285	1032	809	615	450	312	200	114	52	15	0
300	6198	5643	5106	4594	4110	3655	3231	2836	2470	2133	1824	1542	1286	1056	850	668	510	374	260	168
350	7325	6767	6222	5697	5195	4717	4264	3838	3436	3060	2709	2382	2079	1799	1541	1305	1091	898	724	571
400	8451	7892	7342	6808	6292	5798	5324	4874	4445	4039	3656	3294	2953	2634	2335	2056	1797	1557	1336	1133
450	9578	9018	8464	7924	7398	6891	6402	5932	5483	5053	4644	4254	3883	3532	3200	2886	2590	2313	2053	1810
500	10705	10144	9588	9042	8510	7992	7491	7007	6541	6092	5661	5249	4854	4477	4117	3774	3449	3139	2847	2570
550	11831	11270	10713	10163	9625	9100	8589	8093	7613	7149	6701	6270	5855	5456	5073	4706	4355	4019	3699	3393
600	12958	12396	11838	11286	10743	10212	9693	9188	8696	8220	7758	7311	6878	6461	6059	5671	5299	4940	4596	4266
650	14085	13523	12963	12409	11863	11327	10802	10288	9788	9300	8827	8366	7920	7487	7068	6663	6272	5894	5529	5178
700	15211	14650	14089	13534	12985	12444	11914	11394	10886	10389	9905	9434	8975	8529	8096	7675	7268	6873	6491	6121
750	16338	15776	15215	14658	14107	13564	13029	12504	11989	11485	10992	10511	10041	9584	9138	8705	8283	7873	7475	7089
800	17464	16903	16342	15784	15231	14684	14146	13616	13095	12585	12085	11595	11117	10649	10193	9747	9313	8891	8479	8079
850	18591	18029	17468	16909	16355	15806	15264	14731	14205	13689	13183	12686	12199	11723	11257	10801	10357	9922	9499	9085
900	19718	19156	18595	18035	17479	16929	16385	15847	15318	14797	14285	13782	13288	12804	12329	11865	11410	10966	10531	10107
950	20844	20283	19721	19161	18604	18052	17506	16965	16433	15907	15390	14881	14382	13891	13409	12936	12473	12019	11575	11140
1000	21971	21409	20848	20287	19730	19176	18628	18085	17549	17020	16498	15985	15479	14982	14494	14014	13543	13081	12628	12184

### Savings in USD/day – Ballast

Bunker price	TC rates [\$/day]																			
	2500	5000	7500	10000	12500	15000	17500	20000	22500	25000	27500	30000	32500	35000	37500	40000	42500	45000	47500	50000
100	2451	1901	1387	959	619	360	176	59	5	0	0	0	0	0	0	0	0	0	0	0
150	3900	3410	2852	2325	1852	1439	1085	786	540	344	194	89	25	0	0	0	0	0	0	0
200	5298	4903	4361	3803	3269	2775	2324	1919	1557	1238	960	720	518	351	218	118	49	10	0	0
250	6663	6365	5866	5311	4753	4216	3709	3237	2800	2398	2033	1701	1402	1136	900	694	517	367	245	148
300	8007	7799	7354	6820	6261	5704	5164	4649	4162	3704	3276	2878	2509	2169	1857	1572	1313	1080	872	687
350	9337	9208	8822	8320	7772	7210	6655	6114	5593	5095	4623	4175	3754	3358	2987	2641	2319	2020	1745	1491
400	10660	10596	10270	9806	9277	8722	8160	7605	7063	6538	6033	5550	5088	4649	4232	3838	3465	3114	2785	2476
450	11980	11968	11699	11276	10773	10230	9672	9111	8556	8013	7485	6974	6482	6009	5556	5123	4710	4317	3944	3589
500	13300	13326	13111	12731	12257	11732	11182	10621	10061	9507	8963	8432	7917	7418	6937	6473	6027	5599	5189	4797
550	14408	14674	14509	14171	13729	13225	12688	12133	11571	11011	10457	9913	9380	8862	8358	7869	7396	6940	6500	6076
600	15478	16013	15895	15598	15188	14709	14187	13641	13083	12521	11961	11408	10863	10329	9807	9299	8804	8324	7859	7409
650	16542	17346	17269	17013	16636	16181	15678	15144	14592	14033	13471	12912	12358	11813	11278	10754	10242	9742	9256	8783
700	17600	18674	18633	18416	18072	17644	17160	16640	16098	15543	14982	14421	13862	13309	12764	12227	11701	11186	10682	10191
750	18656	19998	19990	19809	19498	19096	18634	18130	17599	17051	16494	15932	15371	14813	14260	13714	13176	12648	12131	11623
800	19708	21320	21339	21193	20914	20539	20098	19611	19093	18554	18002	17444	16882	16321	15763	15210	14664	14126	13596	13076
850	20759	22640	22682	22568	22320	21973	21554	21085	20581	20053	19508	18954	18394	17832	17271	16714	16161	15615	15076	14545
900	21807	23960	24020	23936	23718	23397	23002	22552	22063	21546	21010	20461	19904	19343	18782	18221	17664	17112	16565	16026
950	22854	25280	25354	25297	25108	24814	24441	24011	23537	23033	22507	21965	21413	20854	20293	19732	19171	18615	18062	17516
1000	23900	26600	26684	26653	26491	26223	25873	25462	25005	24514	23998	23465	22918	22364	21805	21243	20681	20122	19565	19013

## The Meyer Model

As mentioned, the Meyer model does not separate between laden and ballast. These calculations are done like described for the Haugen model (in the beginning of the appendix).

### Savings in USD/mile

Bunker price [\$/ton]	TC rates [\$/day]																			
	2500	5000	7500	10000	12500	15000	17500	20000	22500	25000	27500	30000	32500	35000	37500	40000	42500	45000	47500	50000
100	43	35	29	24	20	16	13	11	9	7	5	4	3	2	1	1	0	0	0	0
150	69	59	51	44	39	34	30	27	23	20	18	16	13	12	10	8	7	6	4	3
200	96	84	75	67	60	55	50	45	41	37	34	30	28	25	22	20	18	16	14	13
250	122	110	99	90	83	76	70	65	60	56	51	48	44	41	38	35	32	29	27	25
300	149	136	124	115	106	99	92	86	81	75	71	66	62	58	55	51	48	45	42	39
350	177	162	150	139	130	122	115	108	102	96	91	86	81	77	73	69	65	62	58	55
400	203	188	175	164	155	146	138	131	124	118	112	107	101	97	92	88	83	79	76	72
450	230	214	201	189	179	170	162	154	147	140	134	128	122	117	112	107	103	98	94	90
500	258	241	227	215	204	194	186	177	170	163	156	150	144	138	132	127	122	118	113	109
550	285	271	253	241	229	219	210	201	193	186	178	172	165	159	154	148	143	138	133	128
600	312	298	281	266	255	244	234	225	217	209	201	194	188	181	175	169	164	158	153	148
650	339	326	308	292	280	269	259	250	241	233	225	217	210	204	197	191	185	179	174	169
700	367	353	336	318	306	295	284	274	265	257	248	241	233	226	219	213	207	201	195	190
750	394	380	363	346	332	320	309	299	290	281	272	264	256	249	242	235	229	223	217	211
800	421	408	391	373	357	345	334	324	314	305	296	288	280	272	265	258	251	245	239	233
850	448	435	418	401	383	371	360	349	339	329	320	312	304	296	288	281	274	267	261	254
900	475	462	446	428	411	397	385	374	364	354	345	336	327	319	312	304	297	290	283	277
950	503	489	473	456	438	423	411	400	389	379	369	360	352	343	335	327	320	313	306	299
1000	530	516	501	483	466	449	436	425	414	404	394	385	376	367	359	351	343	336	329	322

### Savings in USD/day

Bunker price [\$/ton]	TC rates [\$/day]																			
	2500	5000	7500	10000	12500	15000	17500	20000	22500	25000	27500	30000	32500	35000	37500	40000	42500	45000	47500	50000
100	7 147	7 715	7 189	6 452	5 679	4 927	4 217	3 560	2 957	2 410	1 918	1 479	1 092	754	465	222	24	0	0	0
150	10 977	12 177	11 898	11 244	10 463	9 643	8 824	8 025	7 256	6 522	5 826	5 169	4 551	3 972	3 432	2 930	2 464	2 034	1 640	1 279
200	14 669	16 493	16 509	16 006	15 295	14 492	13 652	12 804	11 963	11 140	10 340	9 566	8 821	8 105	7 419	6 764	6 139	5 544	4 978	4 442
250	18 288	20 689	21 014	20 693	20 089	19 345	18 529	17 679	16 816	15 954	15 101	14 263	13 443	12 645	11 869	11 117	10 389	9 685	9 007	8 353
300	21 882	24 792	25 424	25 297	24 821	24 159	23 394	22 569	21 713	20 842	19 968	19 098	18 237	17 389	16 556	15 741	14 945	14 168	13 411	12 675
350	22 572	28 823	29 751	29 824	29 486	28 922	28 223	27 442	26 612	25 752	24 877	23 995	23 114	22 239	21 372	20 517	19 675	18 848	18 037	17 242
400	24 536	32 801	34 007	34 280	34 087	33 628	33 007	32 282	31 491	30 656	29 794	28 916	28 030	27 143	26 257	25 378	24 507	23 647	22 798	21 962
450	27 082	36 743	38 205	38 673	38 627	38 279	37 743	37 083	36 339	35 539	34 701	33 837	32 958	32 070	31 178	30 286	29 398	28 516	27 642	26 777
500	30 286	40 665	42 354	43 011	43 110	42 877	42 431	41 841	41 152	40 394	39 587	38 746	37 882	37 001	36 112	35 217	34 321	33 427	32 537	31 653
550	33 490	41 785	46 464	47 299	47 543	47 426	47 072	46 556	45 927	45 217	44 448	43 636	42 792	41 927	41 046	40 156	39 260	38 361	37 463	36 567
600	36 694	44 552	49 826	51 544	51 930	51 928	51 668	51 230	50 665	50 006	49 279	48 500	47 684	46 838	45 973	45 092	44 201	43 304	42 404	41 502
650	39 898	47 193	53 182	55 753	56 275	56 387	56 223	55 864	55 365	54 761	54 080	53 339	52 552	51 732	50 885	50 019	49 138	48 247	47 350	46 448
700	43 102	49 717	56 424	59 930	60 582	60 807	60 738	60 460	60 028	59 482	58 849	58 149	57 396	56 604	55 780	54 932	54 065	53 185	52 294	51 396
750	46 305	52 131	59 559	63 479	64 856	65 191	65 216	65 019	64 657	64 170	63 587	62 930	62 214	61 453	60 655	59 828	58 979	58 112	57 231	56 341
800	49 509	54 441	62 595	66 996	69 101	69 541	69 660	69 544	69 252	68 825	68 295	67 683	67 006	66 277	65 508	64 705	63 876	63 025	62 159	61 279
850	52 713	56 653	65 537	70 420	73 320	73 862	74 072	74 037	73 815	73 450	72 973	72 407	71 771	71 078	70 339	69 562	68 755	67 924	67 073	66 205
900	55 917	58 769	68 391	73 755	76 993	78 155	78 455	78 499	78 347	78 044	77 622	77 104	76 510	75 853	75 146	74 398	73 616	72 805	71 972	71 120
950	59 121	60 795	71 161	77 008	80 611	82 424	82 810	82 932	82 851	82 610	82 242	81 774	81 223	80 605	79 931	79 213	78 456	77 668	76 855	76 020
1000	62 325	62 733	73 851	80 182	84 149	86 670	87 140	87 339	87 327	87 148	86 836	86 417	85 910	85 331	84 693	84 005	83 276	82 513	81 721	80 904

## **Appendix H: TD3 Assumptions to Find TCE**

We have used the Baltic Exchange as a standard of reference for *every* assumption made in the calculations of the Time Charter Equivalent on TD3. The Baltic Exchange data includes port days, port waiting days, discharging days, loading days, port cost, fuel consumption, distances, service speed, weather margin and intake. This is why some figures are denoted differently than earlier. We have taken this into account in our calculations, and it does not affect the results.

For every loop there is some consumption while loading and discharging. For our respective route, it is assumed 2 days loading and 2 days discharging. The consumption is respectively 20 tonne and 85 tonne per day while loading and discharging. The laden consumption is 100 tonnes per day, while the daily ballast consumption is 80 tonnes. There is also assumed 1 day waiting in the loop with an IFO consumption of 10 tonnes. To find the bunker cost, we simply add together the total IFO consumption and multiply it with the Singapore 380 cSt bunker price (the bunker price varies between different bunker locations). We use Singapore 380 cSt, since this is the main bunker station on the TD3 route. This gives us the total fuel cost for TD3. To find the total expenses for a trip, port charges are added. The ports visited are Ras Tanura (Saudi Arabia) and Chiba (Japan). A 2.5% commission is subtracted from the freight income (Baltic Exchange, 2012).

The assumptions are listed on the next site.

### ***Assumptions TD3***

---

Normal speed laden	14,5 knot
Normal speed ballast	14,5 knot
Normal consumption laden	100 tonne/day
Normal consumption ballast	80 tonne/day
Distance laden	6 655 miles
Distance ballast	6 650 miles
Port cost load	50 000 USD
Port cost discharging	50 000 USD
Port days load	2 days
Port days discharging	2 days
Extra port days	1,5 days
Port cons load	20 tonne/day
Port cons discharging	85 tonne/day
Port cons waiting	10 tonne/day
Weather margin	5 %
Intake	265 000 tonne
Freight income**	14 USD/tonne
Commission	2,5 %
Net income	13,65 USD/tonne
Net bunker price*	700 USD/tonne

*\*: Data gathered 8th May*

*\*\*: variable in calculations shown*

---

*Source: The Baltic Exchange*

## **Appendix I: TD3 Assumptions to Find CO<sub>2</sub> Emissions with Different Speed Levels**

We assume that CO<sub>2</sub> emissions do not depend on type of fuel used or engine type. To estimate total CO<sub>2</sub> emissions one multiplies total bunker consumption (tonne per day) by a factor of 3.17. The CO<sub>2</sub> factor of 3.17 is the empirical mean value most commonly used in CO<sub>2</sub> emission calculations based on fuel consumption (Psaraftis and Kontovas, 2009).

We will therefore use the constant 3.2 to estimate CO<sub>2</sub> emissions per tonne for a round trip. We will use the TD3 assumptions in this section as well (see appendix H).